



REACTIVE ENERGY REGULATOR

Computer SMART III FAST (Static operation)



INSTRUCTION MANUAL

(M021B01-03-19A)



SAFETY PRECAUTIONS

Follow the warnings described in this manual with the symbols shown below.

	<p>DANGER Warns of a risk, which could result in personal injury or material damage.</p>
---	---

	<p>ATTENTION Indicates that special attention should be paid to a specific point.</p>
---	--

If you must handle the unit for its installation, start-up or maintenance, the following should be taken into consideration:

	<p>Incorrect handling or installation of the unit may result in injury to personnel as well as damage to the unit. In particular, handling with voltages applied may result in electric shock, which may cause death or serious injury to personnel. Defective installation or maintenance may also lead to the risk of fire. Read the manual carefully prior to connecting the unit. Follow all installation and maintenance instructions throughout the unit's working life. Pay special attention to the installation standards of the National Electrical Code.</p>
---	---

	<p>Refer to the instruction manual before using the unit In this manual, if the instructions marked with this symbol are not respected or carried out correctly, it can result in injury or damage to the unit and /or installations.</p>
---	--

CIRCUTOR, SA reserves the right to modify features or the product manual without prior notification.

DISCLAIMER

CIRCUTOR, SA reserves the right to make modifications to the device or the unit specifications set out in this instruction manual without prior notice.

CIRCUTOR, SA on its web site, supplies its customers with the latest versions of the device specifications and the most updated manuals.

www.circutor.com



	<p>CIRCUTOR, recommends using the original cables and accessories that are supplied with the device.</p>
---	---

CONTENTS

SAFETY PRECAUTIONS	3
DISCLAIMER	3
CONTENTS	4
REVISION LOG.....	6
1.- VERIFICATION UPON RECEPTION	7
2.- PRODUCT DESCRIPTION	8
3.- UNIT INSTALLATION	9
3.1.- PRELIMINARY RECOMMENDATIONS	9
3.2.- INSTALLATION	10
3.4.- UNIT TERMINALS	12
3.5.- CONNECTION DIAGRAM	14
3.5.1.- 3 VOLTAGES + NEUTRAL AND 3 CURRENTS, Computer SMART III FAST 6 MODEL	14
3.5.2.- 3 VOLTAGES + NEUTRAL AND 3 CURRENTS, Computer SMART III FAST 12 MODEL	15
3.5.3.- 3 VOLTAGES + NEUTRAL AND 1 CURRENT, Computer SMART III FAST 6 MODEL	16
3.5.4.- 3 VOLTAGES + NEUTRAL AND 1 CURRENT, Computer SMART III FAST 12 MODEL	17
3.5.5.- 2 VOLTAGES AND 1 CURRENT, Computer SMART III FAST 6 MODEL	18
3.5.6.- 2 VOLTAGES AND 1 CURRENT, Computer SMART III FAST 12 MODEL	19
3.5.7.- LEAKAGE CURRENT CONNECTION, Δ	20
3.6.- STARTING UP THE UNIT	21
4.- OPERATION	22
4.1.- DEFINITIONS	23
4.1.1 FOUR-QUADRANT REGULATOR	23
4.1.2 STAGES AND STEPS	23
4.1.3 FCP SYSTEM (FAST COMPUTERIZED PROGRAM)	23
4.1.4 REGULATION PROGRAM	23
4.1.5. PLUG AND PLAY	24
4.1.6 CONNECTION TIME (TON) AND RECONNECTION TIME (TREC)	24
4.1.7 THD AND HARMONICS	24
4.2.- MEASUREMENT PARAMETERS	25
4.2.1. CONNECTION TYPE: 3U. 3C	25
4.2.2. CONNECTION TYPE: 3U. 1C	26
4.2.3. CONNECTION TYPE: 2U. 1C	27
4.3.- KEY FUNCTIONS	28
4.4.- DISPLAY	30
4.4.1. STATUS OF THE CAPACITORS	31
4.4.2. STATUS OF THE UNIT	31
4.4.3. ANALOGUE BAR	32
4.4.4. OTHER SYMBOLS ON THE DISPLAY	32
4.5.- LED INDICATORS	33
4.6.- OPERATING STATES	34
4.6.1. MEASUREMENT STATUS	34
4.6.2. TEST STATUS	54
4.7.- INPUTS	57
4.8.- OUTPUTS	57
4.9.- RS-485 COMMUNICATIONS	58
4.9.1. CONNECTIONS	58
4.9.2. PROTOCOL	59
4.9.3. MODBUS MEMORY MAP	60
4.9.4. EXAMPLE OF A MODBUS QUERY	68
4.10.- CPC-NET COMMUNICATIONS	69
4.10.1. MODBUS CONTROL FRAME	70
5.- CONFIGURATION	71
5.1.- PLUG&PLAY	72
5.2.- CURRENT TRANSFORMATION RATIO	75
5.3.- TARGET COS ϕ	76
5.4.- CONNECTION AND RECONNECTION TIME	77
5.5.- CONNECTION TYPE	78
5.6.- PHASE CONNECTION	78

5.7.- NO. OF STAGES	80
5.8.- PROGRAM	81
5.9.- C/K FACTOR	82
5.10.- ADVANCED SETUP	84
5.11.- VOLTAGE TRANSFORMATION RATIO.....	85
5.12.- STATUS OF THE STAGES.....	86
5.13.- DISPLAY	87
5.14.- ANALOGUE BAR	88
5.15.- FAN	89
5.16.- RS-485 COMMUNICATIONS.....	90
5.17.- CPC-NET COMMUNICATIONS.....	91
5.18.- CLEAR.....	92
5.19.- ENABLING ALARMS	93
5.20.- VOLTAGE ALARMS	94
5.21.- COS φ ALARM.....	95
5.22.- VOLTAGE THD ALARM	96
5.23.- CURRENT \times I THD ALARM	97
5.24.- TEMPERATURE ALARM	98
5.25.- LEAKAGE CURRENT ALARM	100
5.26.- NO. OF OPERATIONS ALARM	101
5.27.- SIMULATION SCREEN	102
6.- TECHNICAL FEATURES	103
7.- MAINTENANCE AND TECHNICAL SERVICE.....	106
8.- WARRANTY.....	106
9.- CE CERTIFICATE.....	107

REVISION LOG**Table 1: Revision log.**

Date	Revision	Description
04/14	M021B01-03-14A	Initial Version
05/16	M021B01-03-16A	Changes in sections: 6.
03/17	M021B01-03-17A	Changes in sections: 4.9.3.
03/18	M021B01-03-18A	Changes in sections: 4.9.3. - 5.13. - 9
01/19	M021B01-03-19A	Changes in sections: 4.9.3.

1.- VERIFICATION UPON RECEPTION

Check the following points when you receive the unit:

- a) The unit meets the specifications described in your order.
- b) The unit has not suffered any damage during transport.
- c) Check the features shown on the label of the unit to make sure that they are suitable for the type of grid to which the unit will be connected. (Voltage and power supply frequency, measurement range, etc.)
- d) Perform an external visual inspection of the unit prior to switching it on.
- e) Check that it has been delivered with the following:
 - An installation guide,
 - Four retainers for rear attachment of the unit,



If any problems are detected upon reception, immediately contact the transport company and/or the **CIRCUTOR S.A.** after-sales service.

2.- PRODUCT DESCRIPTION

The **Computer SMART III FAST** reactive energy regulator is a unit that measures the grid cosine and regulates capacitor connection and disconnection in order to correct it. It also calculates and displays the main electrical parameters of balanced or unbalanced single-phase and three-phase networks. The measurement is taken in RMS, via four AC voltage inputs and three current inputs.

There are 2 versions of the unit, according to the number of output relays:

- ✓ **Computer SMART III FAST 6**, with six optoMOS relay outputs.
- ✓ **Computer SMART III FAST 12**, with twelve optoMOS relay outputs.



The unit features:

- **5 keys** that can be used to browse the various screens and program the unit.
- **4 indicator LEDs**: CPU, ALARM, FAN and KEY PRESSED.
- **LCD display**, amber backlit, 70x60.7 mm display for viewing all the parameters.
- **2 digital inputs**, for selecting the target cosine (4 target cosines).
- **2 digital outputs and 1 relay output**, fully programmable as alarms.
- **1 relay output**, specific for the fan.
- **6 optoMOS relay outputs** (**Computer SMART FAST III 6** model) or **12 optoMOS relay outputs** (**Computer SMART FAST III 12** model) for regulating the $\cos \phi$ by means of capacitors.
- **RS-485** communications, MODBUS RTU©.
- **CPC-NET** communications port.

3.- UNIT INSTALLATION

3.1.- PRELIMINARY RECOMMENDATIONS



In order to use the unit safely, it is critical that individuals who handle it follow the safety measures set out in the standards of the country where it is being used, use the personal protective equipment necessary, and pay attention to the various warnings indicated in this instruction manual.

The **Computer SMART III FAST** unit must be installed by authorised and qualified staff.

The power supply plug must be disconnected and measuring systems switched off before handling, altering the connections or replacing the unit. It is dangerous to handle the unit while it is powered.

Also, it is critical to keep the cables in perfect condition in order to avoid accidents, personal injury and damage to installations.

The manufacturer of the unit is not responsible for any damage resulting from failure by the user or installer to heed the warnings and/or recommendations that appear in this manual, nor for damage resulting from the use of products or accessories that did not come with the unit or that were made by other manufacturers.

If an anomaly or malfunction is detected in the unit, do not use the unit to take any measurements.

Inspect the work area before taking any measurements. Do not take measurements in dangerous areas or where there is a risk of explosion.



Disconnect the unit from the power supply (unit and measuring system power supply) before maintaining, repairing or handling the unit's connections. Please contact the after-sales service if you suspect that there is an operational fault in the unit.

3.2.- INSTALLATION



The **Computer SMART III FAST** regulator is connected to units that contain capacitors, which remain charged after the voltage source is disconnected. **Wait at least 5 minutes** after the unit is disconnected before handling its internal components in order to avoid the risk of electric shock.

Any manipulation or use of the unit other than that specified by the manufacturer may compromise user safety.

Make sure that the units are correctly earthed before they are connected. A faulty earth connection could lead to faulty operation and lead to a risk of electrical shock for the user or person handling the unit.

Resonance can occur when the unit is connected with no load. In this case, the voltage harmonics can be amplified, causing damage to the compensation unit and other units connected to the mains.

The safe use of the **COMPUTER SMART III FAST** requires the persons installing or handling it to follow the general safety measures of LV electrical installations, as well as the warnings indicated in this instruction manual.

The unit will be installed on a panel (138+1 x 138+1 mm panel drill hole, in compliance with DIN 43700). All connections are inside the electric panel.



Terminals, opening roofs or removing elements can expose parts that are hazardous to the touch while the unit is powered. Do not use the unit until it is fully installed.

The unit must be connected to a power circuit that is protected with gl (IEC 269) or M type fuses with a rating of 0.5 to 2 A. It must be fitted with a circuit breaker or equivalent device for disconnecting the unit from the power supply mains.

The power and voltage measurement circuits as well as the relay contact circuits must be connected with cables that have a minimum cross-section of 1.5 mm².

One or three external current transformers (CT) need to be installed in order to measure current. Usually, the transformation ratio of these CTs is $I_n/5$ A, where I_n is at least 1.5 times the total maximum load current.

The secondary cables of the current transformers (CT) must have a minimum cross-section of 2.5 mm². For distances between the CTs and the unit of more than 25 m, this cross-section should be increased by 1 mm² for every 10 m.

The current transformers (CT) must be installed at a point in the distribution panel which carries all the current of the loads to be compensated as well as the current of the capacitors themselves (**Figure 1**).

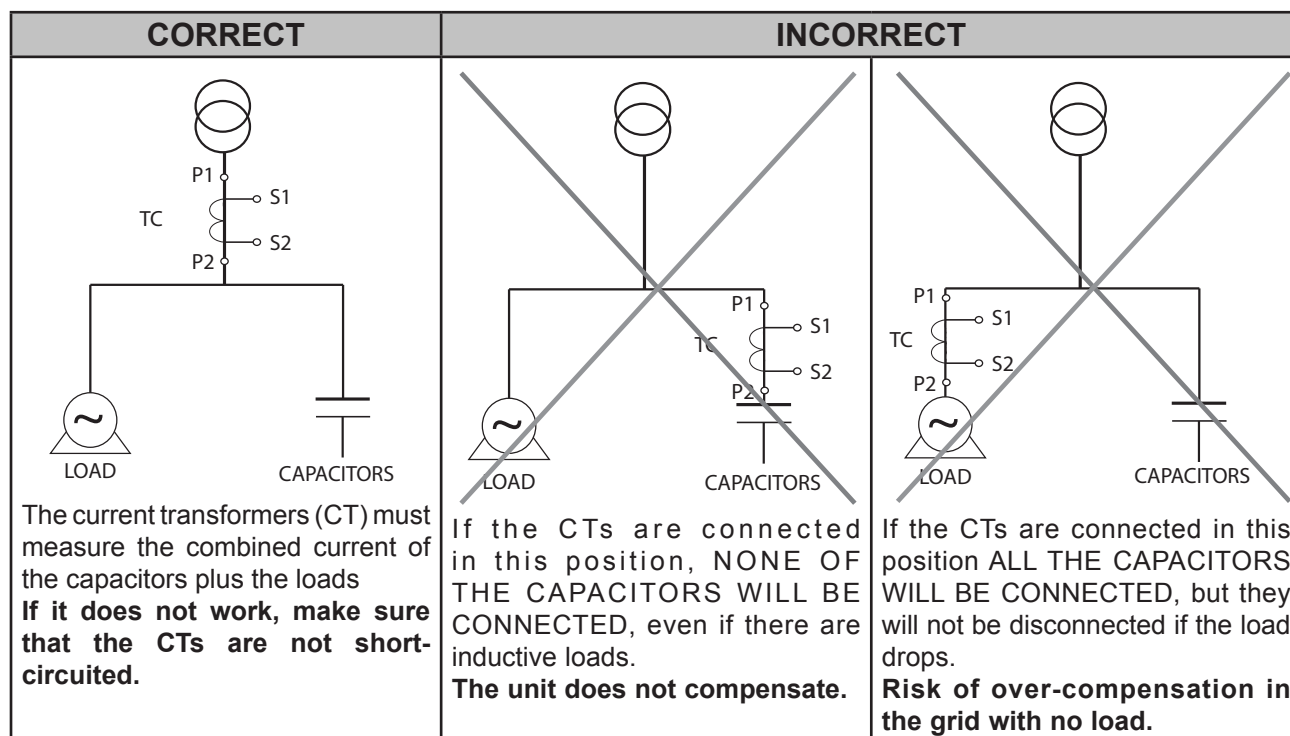

Figure 1: Location of the current transformers

3.4.- UNIT TERMINALS

Table 2:List of Computer SMART III FAST terminals.

Terminals of the top side of the unit	
1: A1 , Auxiliary power supply.	23: 8 , Output 8 (Computer SMART III FAST 12 model)
2: A2 , Auxiliary power supply.	24: 9 , Output 9 (Computer SMART III FAST 12 model)
3: V_{L1} , L1 voltage input	25: 10 , Output 10 (Computer SMART III FAST 12 model)
4: V_{L2} , L2 voltage input	26: 11 , Output 11 (Computer SMART III FAST 12 model)
5: V_{L3} , L3 voltage input	27: 12 , Output 12 (Computer SMART III FAST 12 model)
6: V_{LN} , Neutral voltage input	28: A(+) , RS-485
7: S1 , L1 current input	29: B(-) , RS-485
8: S2 , L1 current input	30: S , GND for RS-485
9: S1 , L2 current input	31: 1 , Digital input 1
10: S2 , L2 current input	32: 2 , Digital input 2
11: S1 , L3 current input	33: C , Digital inputs common
12: S2 , L3 current input	34: 1 , Digital output 1
13: S1 , Leakage current input	35: 2 , Digital output 2
14: S2 , Leakage current input	36: C , Digital outputs common
15: COM , Outputs common	37: Fan relay output
16: 1 , Output 1	38: Fan relay output
17: 2 , Output 2	39: NC , Alarm relay output
18: 3 , Output 3	40: C , Alarm relay output
19: 4 , Output 4	41: NO , Alarm relay output
20: 5 , Output 5	42: A(+) , CPC-NET
21: 6 , Output 6	43: B(-) , CPC-NET
22: 7 , Output 7 (Computer SMART III FAST 12 model)	44: S , GND for CPC-NET

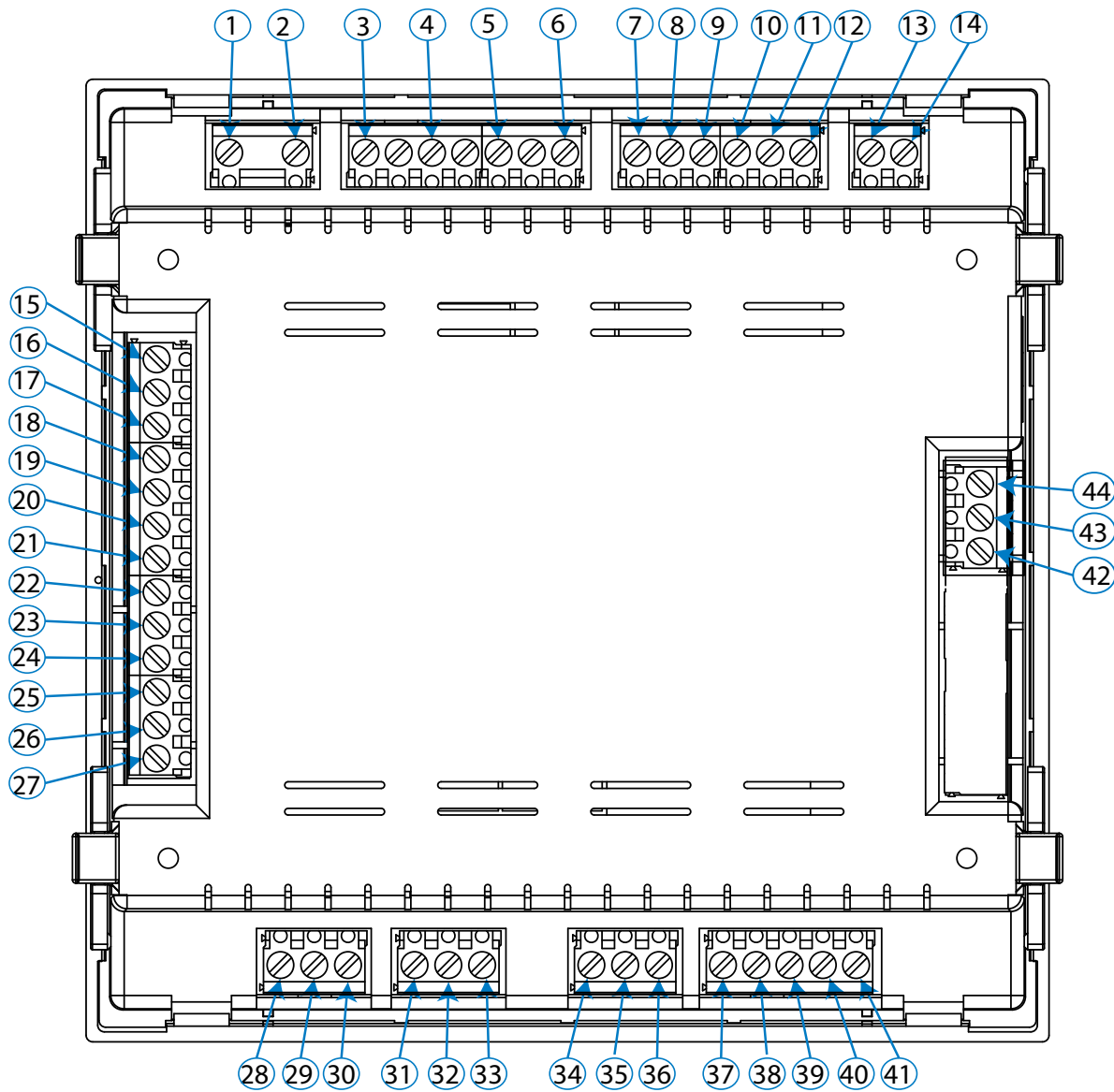

Figure 2: Computer SMART III FAST terminals.

3.5.- CONNECTION DIAGRAM

3.5.1.- 3 voltages + Neutral and 3 currents, Computer SMART III FAST 6 model.

Connection type: 3U.3E

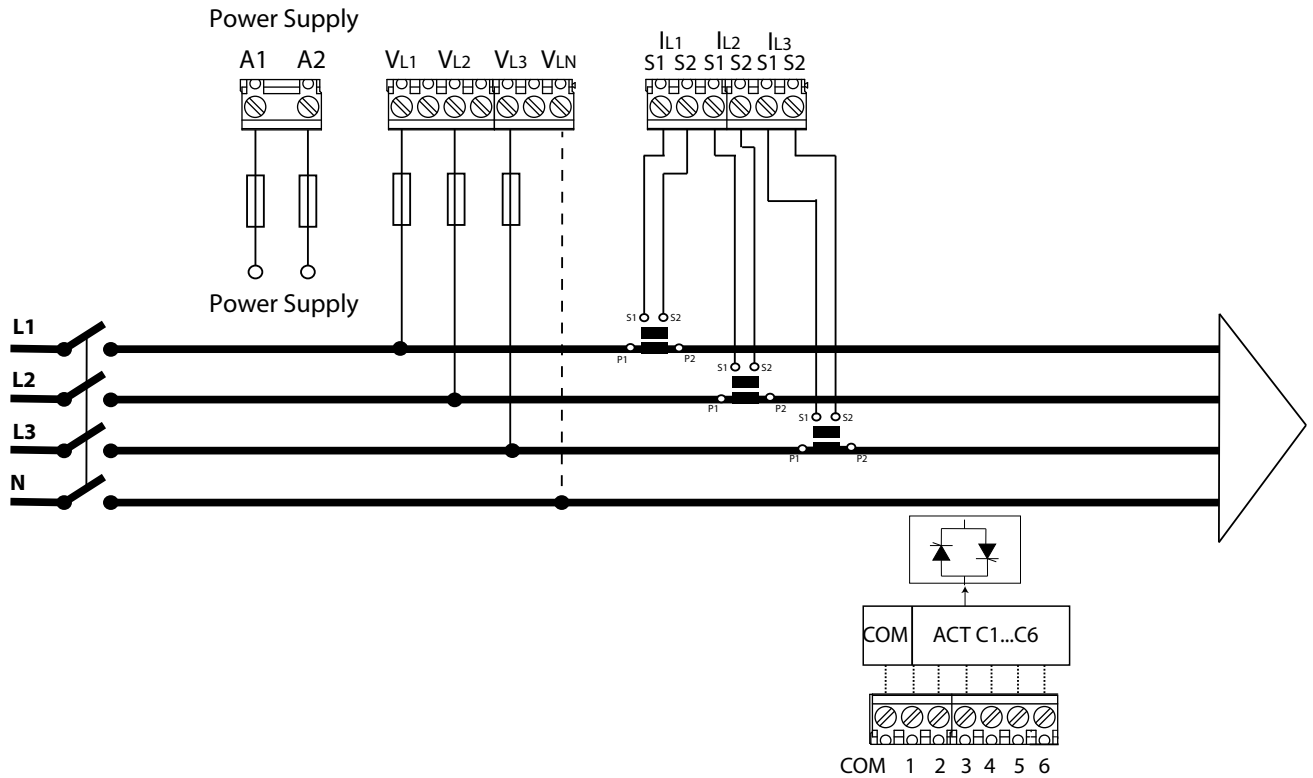

Figure 3: 3 voltages + Neutral and 3 currents, Computer SMART III FAST 6 model.

Note: If the connection layout mentioned above is not respected, you must adjust the phase following the procedure described in section "5.6.- PHASE CONNECTION"

Note: In this type of connection, the connection from Neutral to V_{LN} is not mandatory.

3.5.2.- 3 voltages + Neutral and 3 currents, Computer SMART III FAST 12 model.

Connection type: 3U.3C

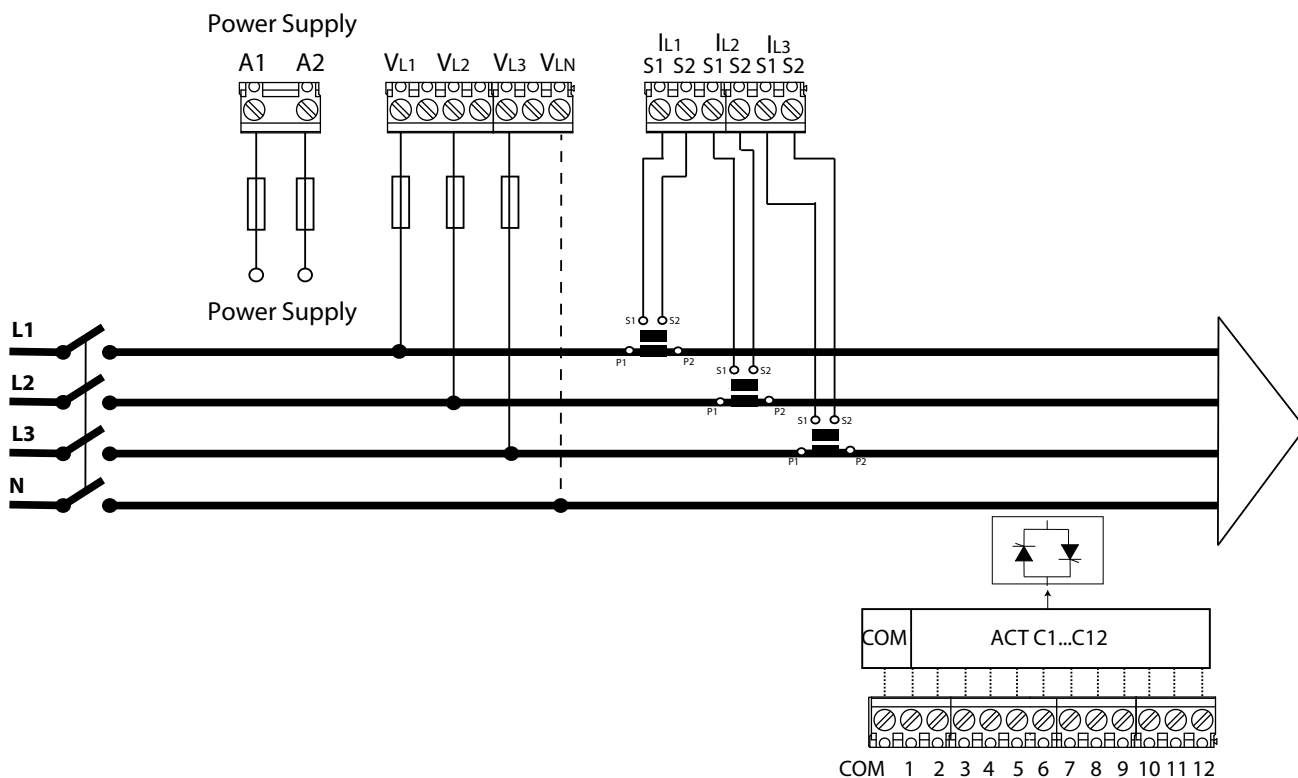

Figure 4: 3 voltages + Neutral and 3 currents, Computer SMART III FAST 12 model.

Note: If the connection layout mentioned above is not respected, you must adjust the phase following the procedure described in section "5.6.- PHASE CONNECTION"

Note: In this type of connection, the connection from Neutral to V_{LN} is not mandatory.

3.5.3.- 3 voltages + Neutral and 1 current, Computer SMART III FAST 6 model.

Connection type: 3U. 1C

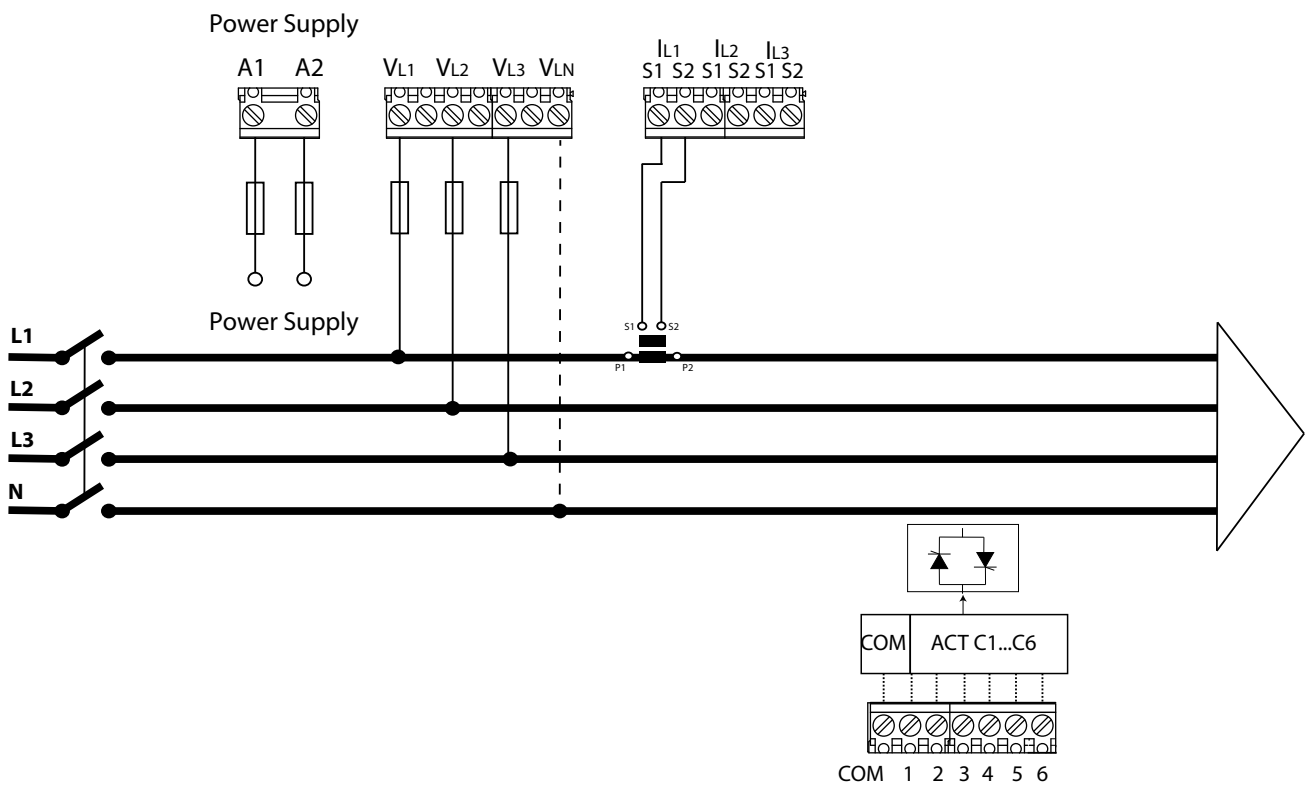

Figure 5: 3 voltages + Neutral and 1 current, Computer SMART III FAST 6 model.

Note: If the connection layout mentioned above is not respected, you must adjust the phase following the procedure described in section "5.6.- PHASE CONNECTION"

Note: In this type of connection, the connection from Neutral to V_{LN} is not mandatory.

Note: In this type of connection, the current transformer must be connected to the IL1 terminals.

3.5.4.- 3 voltages + Neutral and 1 current, Computer SMART III FAST 12 model.

Connection type: 3U. 1C

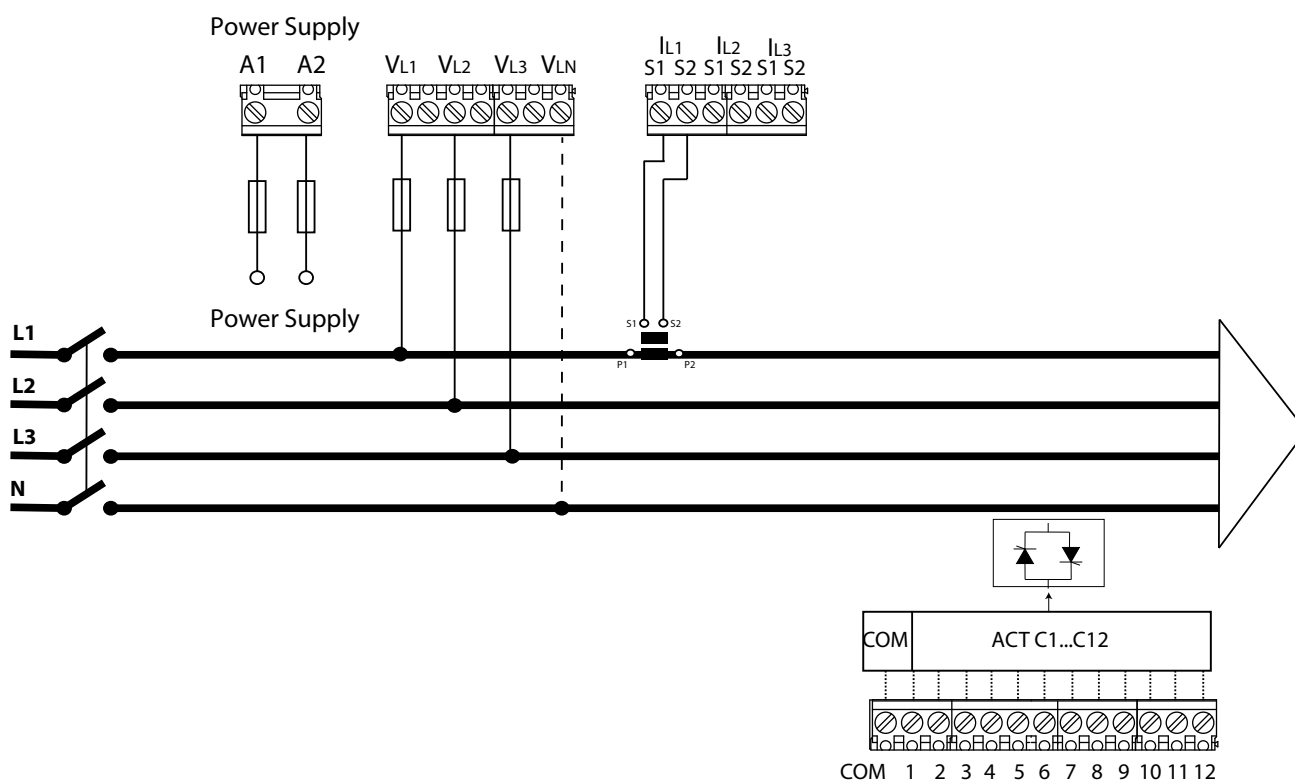

Figure 6: 3 voltages + Neutral and 1 current, Computer SMART III FAST 12 model.

Note: If the connection layout mentioned above is not respected, you must adjust the phase following the procedure described in section "5.6.- PHASE CONNECTION"

Note: In this type of connection, the connection from Neutral to V_{LN} is not mandatory.

Note: In this type of connection, the current transformer must be connected to the $IL1$ terminals.

3.5.5.- 2 voltages and 1 current, Computer SMART III FAST 6 model.

Connection type: 2U. 1C

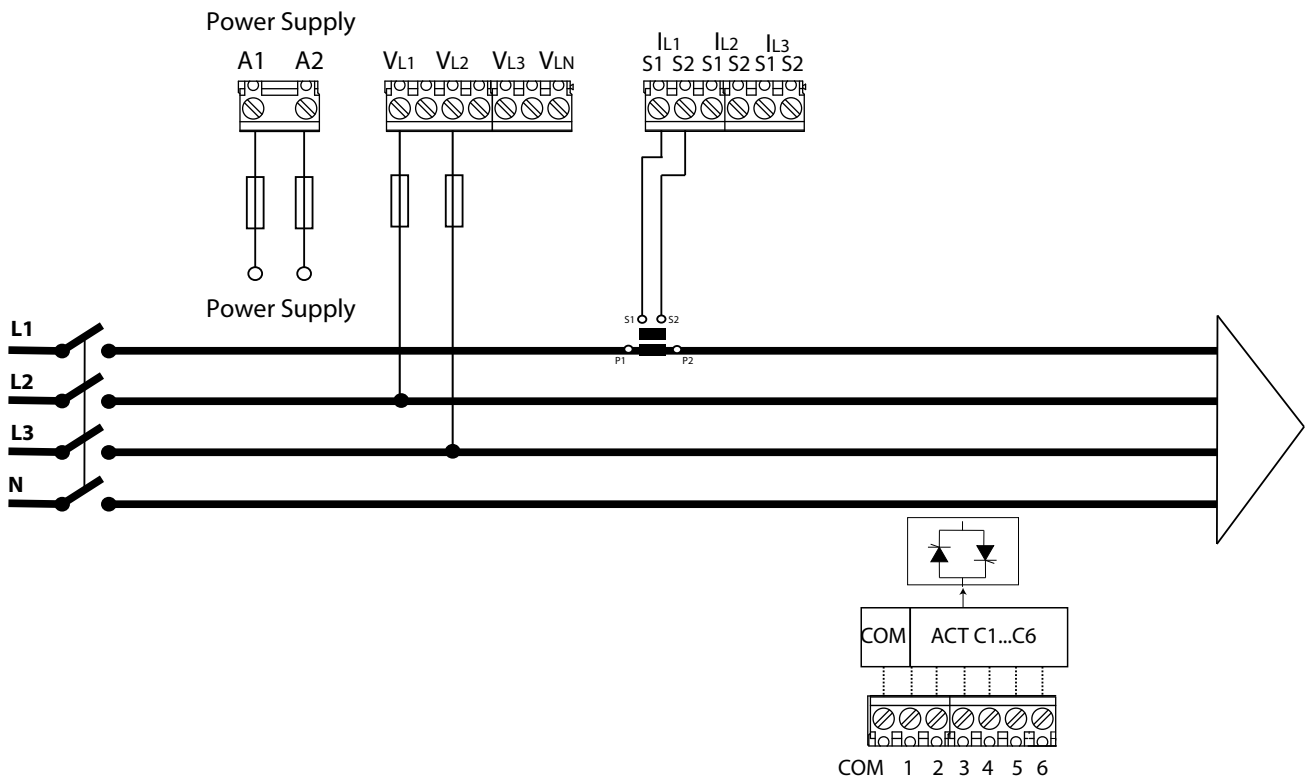

Figure 7: 2 voltages and 1 current, Computer SMART III FAST 6 model.

Note: If the connection layout mentioned above is not respected, you must adjust the phase following the procedure described in section "5.6.- PHASE CONNECTION"

Note: In this type of connection, the Neutral connection is not necessary.

Note: In this type of connection, the current transformer must be connected to the IL1 terminals, and the two voltages must be connected to VL1 and VL2.

3.5.6.- 2 voltages and 1 current, Computer SMART III FAST 12 model.

Connection type: 2U. 1C

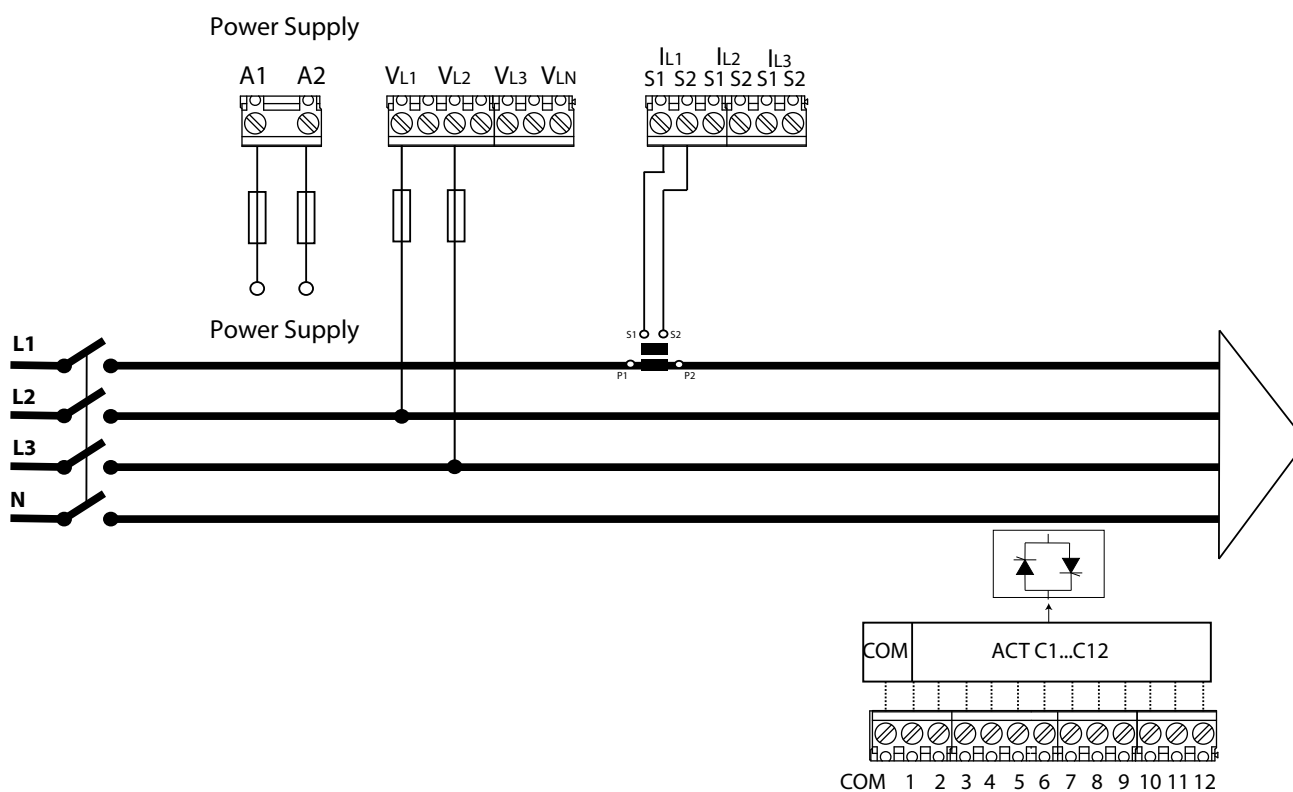

Figure 8: 2 voltages and 1 current, Computer SMART III FAST 12 model.

Note: If the connection layout mentioned above is not respected, you must adjust the phase following the procedure described in section "5.6.- PHASE CONNECTION".

Note: In this type of connection, the Neutral connection is not necessary.

Note: In this type of connection, the current transformer must be connected to the I_{L1} terminals, and the two voltages must be connected to V_{L1} and V_{L2} .

3.5.7.- Leakage current connection, I_{Δ}

To measure the leakage current, an earth leakage transformer must be used, such as **WGS**. The leakage current transformer must be connected such as to measure the current of the capacitor bank. This will detect any leakage in the capacitors of the capacitor bank.

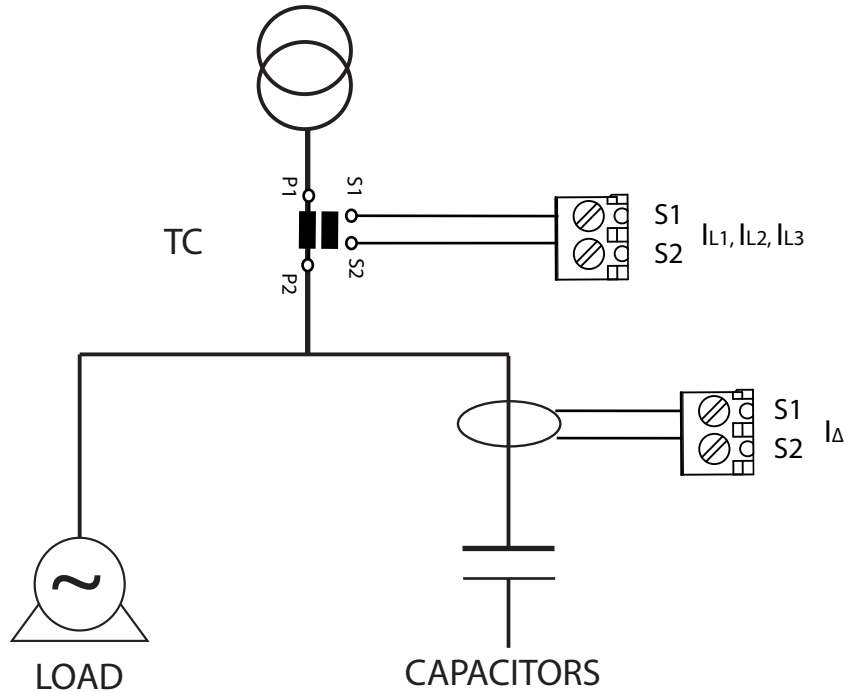



Figure 9: Connection of the leakage current transformer (I_{Δ}).

Note: The earth leakage transformer must have a ratio of 500 turns. The maximum leakage current that the unit can measure correctly is 1.5A AC, even though the maximum input is 5A AC via the earth leakage transformer.

	<p>Do not operate the leakage current transformer with the Computer SMART III FAST powered on.</p>
---	---

3.6.- STARTING UP THE UNIT

Once the **Computer SMART III FAST** is powered on, the following screen appears on the display, **Figure 10**, which shows the name of the unit, the version and the model.



Figure 10: Computer SMART III FAST home screen.

After a few seconds, the main measurement screen appears.

4.- OPERATION

The **Computer SMART III FAST** is a reactive energy regulator unit that measures the $\cos \varphi$ of the grid and that regulates the connection and disconnection of capacitors in order to correct it. The control is carried out in the four quadrants, **Figure 11**.

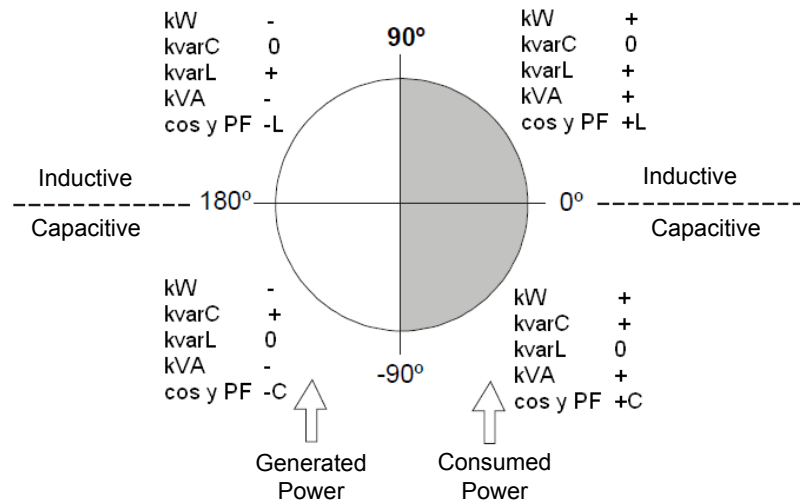

Figure 11: Measurement and Compensation in the four quadrants.

In addition to the basic functions of any regulator the **Computer SMART III FAST**:

- ✓ Performs the functions of a network analyzer, measuring and displaying multiple parameters.
- ✓ Has a Plug&Play function for automatic configuration of the unit.
- ✓ Has an AutoTest and manual Test function for testing the status of the capacitor bank capacitors.
- ✓ Has an FCP system which minimises the number of capacitor connections and disconnections.
- ✓ Supports step forcing.
- ✓ Can work with various connection types.
- ✓ Measures leakage current with the option of associating an alarm and conducting a search for and cancelling the faulty capacitor.
- ✓ Has multiple alarms for warning of possible faults, whether in the capacitor bank or in the installation.

4.1.- DEFINITIONS

This section provides a number of definitions that may be useful for understanding the operation of the unit.

4.1.1 Four-quadrant regulator.

This means that the regulator is capable of performing the measurement and regulation functions when the active power is transferred from the mains to the loads (common case in a consumer installation) or when the load is transferred to the mains (in the case of installations with generators that not only allow the consumption of energy, but can also export and sell energy).

4.1.2 Stages and steps

A distinction must be established between stages and steps. In this manual, a **Stage** is described as each group of capacitor banks into which the power factor compensation unit is divided, which may have different power ratings, usually in ratios of 1:1, 1:2, 1:2:4, etc.

A **step** is each one of the total power fractions (power of the first step) that can be regulated by using stages with different weights.

4.1.3 FCP system (FAST Computerized Program).

This system controls the connection sequence of the various stages, tending to minimise the number of operations and to match the usage times of the various stages in order to achieve a pre-determined required final power. The operations are carried out such that, in the case of stages with identical power, the stage that has been disconnected the longest is connected when there is demand and the stage that has been connected the longest is disconnected when there is a surplus.

4.1.4 Regulation program.

The power ratings of the various groups or stages usually follow certain patterns called "programs".

The program indicates the power ratios between the various stages. The most frequent programs are:

Program 1.1.1.1 . All stages have the same power. *For example: a 100 kvar unit with 5 steps would be made up of 5 identical 20 kvar stages, and would be described as a (5 x 20) kvar unit.*

Program 1.2.2.2 . Every stage after the first stage has twice as much power as the first stage. *For example: a 180 kvar unit with 5 stages would be made up of a first 20 kvar stage and 4 identical 40 kvar stages, and would be described as a (20 + 4 x 40) kvar unit.*

Program 1.2.4.4 . The second stage has twice as much power as the first stage and the remaining stages after the second stage have four times as much power as the first stage. *For example: a 300 kvar unit with 5 stages would be made up of a first 20 kvar stage, a second 40 kvar stage and 3 identical 80 kvar stages. It would be described as a (20 + 40 + 3 x 80) kvar unit.*

Other Programs. Other programs can be used, such as 1.2.2.4, 1.2.4.8, 1.1.2.2, etc. The meaning of the numbers, as can be deduced from the preceding cases, gives the power ratio between the first stage, which receives a value of 1, and the subsequent stages (2 means twice as much power, 4 means four times as much power, etc.).

The unit can be used to configure programs from 1.1.1.1 to 1.9.9.9.

4.1.5. Plug and Play.

When a reactive energy regulator is installed, a series of parameters must be configured for its correct operation. Some of these parameters might be difficult to discover, for example, the voltage phases or the correspondence between measured current and its voltage, as well as the current transformer ratio. The **Computer SMART III FAST** includes an automatic process, which intelligently works out necessary parameters such as:

- ✓ **Connection type:** detects the connection type used from among the possible options: 3U.3C, 3U.1C and 2U.1C.
- ✓ **Phase:** identifies the correspondence between the voltages and the currents connected, regardless of the connection type detected previously.
- ✓ **Number of stages installed and Program:** sequentially connects all the stages to work out how many stages are installed and calculates the program, in other words, the power ratio between the capacitors.
- ✓ **C/K:** calculates the ratio between the current transformer and the power of the smallest step.

4.1.6 Connection time (Ton) and Reconnection time (Trec).

The **Connection time, Ton**, defines the shortest possible time between changes in the status of the stages, in other words, between connections and disconnections. Therefore, the configuration of this parameter has a direct impact on the compensation speed, in other words, on the capacity for monitoring load changes. Setting a shorter connection time improves the power factor correction when the load can change quickly.

However, a shorter **Ton** will lead to a higher number of connections per time unit, possibly shortening the useful life of the associated components (thyristors, capacitors). To assess the number of connections, the **Computer Smart III FAST** uses individual energy meters for each stage.

The **Reconnection time, Trec**, is the shortest possible time between disconnecting a stage and reconnecting it. This time is necessary for the capacitor to discharge enough so that, when it is reconnected, it does not cause overcurrents in the system.

Both **Ton** and **Trec** have different time bases for the **Computer SMART III** (in seconds) and for the **Computer SMART III FAST** (in network cycles).

4.1.7 THD and harmonics

Non-linear loads, such as those in rectifiers, inverters, variable speed drivers, furnaces, etc., absorb non-sinusoidal periodic currents from the mains. These currents are made up of a fundamental component with a frequency of 50 or 60 Hz, plus a series of overlapping currents with frequencies that are multiples of the fundamental frequency; these are defined as harmonics. The result is a deformation of the current and, thus, of the voltage, which leads to a series of

related side effects (conductor overload, circuit breakers and machines, phase unbalances, interferences in electronic units, RCCB trips, etc.).

The level of harmonics is usually measured with the total harmonic distortion rate (THD), which is the ratio, usually as a %, of the RMS value of the harmonic content and the value of the fundamental component.

4.2.- MEASUREMENT PARAMETERS

The unit displays the following electrical parameters:

4.2.1. Connection type: 3U.3C

Table 3: Computer SMART III FAST measurement parameters (3U.3C connection)

Parameter	Units	Phases L1-L2-L3	N	Total III	Max ⁽¹⁾	Min ⁽²⁾
Phase-neutral voltage	V	✓		✓	✓	✓
Phase-phase voltage	V	✓		✓	✓	✓
Current	A	✓	✓		✓	✓
Leakage current	mA		✓		✓	✓
Frequency	Hz	✓(L1)			✓	✓
Active Power	M/kW	✓		✓	✓	✓
Apparent Power	M/kVA	✓		✓	✓	✓
Total Reactive Power	M/kvar	✓		✓	✓	✓
Inductive Reactive Power	M/kvarL	✓		✓	✓	✓
Capacitive Reactive Power	M/kvarC	✓		✓	✓	✓
Power factor	PF	✓		✓	✓	✓
Cos φ	φ	✓		✓	✓	✓
Voltage THD %	% THD V	✓			✓	
Current THD %	% THD A	✓			✓	
Harmonic Breakdown - Voltage (up to the 17th harmonic)	harm V	✓			✓	
Harmonic Breakdown - Current (up to the 17th harmonic)	harm A	✓			✓	
Active energy	M/kWh			✓		
Inductive Reactive Energy	M/kvarLh			✓		
Capacitive Reactive Energy	M/kvarCh			✓		
Apparent energy	M/kVAh			✓		
Temperature	°C			✓		
No. of operations	x1000			✓		
Total activated power	%			✓		

⁽¹⁾ Displays the maximum value.

⁽²⁾ Displays the minimum value.

4.2.2. Connection type: 3U. 1C

Table 4: Computer SMART III FAST measurement parameters (3U. 1C connection)

Parameter	Units	Phases L1-L2-L3	N	Total III	Max ⁽³⁾	Min ⁽⁴⁾
Phase-neutral voltage	V	✓		✓	✓	✓
Phase-phase voltage	V	✓		✓	✓	✓
Current	A	✓(L1)			✓	✓
Leakage current	mA		✓		✓	✓
Frequency	Hz	✓(L1)			✓	✓
Active Power	M/kW			✓	✓	✓
Apparent Power	M/kVA			✓	✓	✓
Total Reactive Power	M/kvar			✓	✓	✓
Inductive Reactive Power	M/kvarL			✓	✓	✓
Capacitive Reactive Power	M/kvarC			✓	✓	✓
Power factor	PF			✓	✓	✓
Cos φ	φ			✓	✓	✓
Voltage THD %	% THD V	✓			✓	
Current THD %	% THD A	✓(L1)			✓	
Harmonic Breakdown - Voltage (up to the 17th harmonic)	harm V	✓			✓	
Harmonic Breakdown - Current (up to the 17th harmonic)	harm A	✓(L1)			✓	
Active energy	M/kWh			✓		
Inductive Reactive Energy	M/kvarLh			✓		
Capacitive Reactive Energy	M/kvarCh			✓		
Apparent energy	M/kVAh			✓		
Temperature	°C			✓		
No. of operations	x1000			✓		
Total activated power	%			✓		

⁽³⁾ Displays the maximum value.

⁽⁴⁾ Displays the minimum value.

4.2.3. Connection type: 2U. 1C

Table 5: Computer SMART III FAST measurement parameters (2U. 1C connection)

Parameter	Units	Phases L1-L2-L3	N	Total III	Max ⁽⁵⁾	Min ⁽⁶⁾
Phase-neutral voltage	V					
Phase-phase voltage	V			✓(L1-L2)	✓	✓
Current	A	✓(L1)			✓	✓
Leakage current	mA		✓		✓	✓
Frequency	Hz	✓(L1)			✓	✓
Active Power	M/kW			✓	✓	✓
Apparent Power	M/kVA			✓	✓	✓
Total Reactive Power	M/kvar			✓	✓	✓
Inductive Reactive Power	M/kvarL			✓	✓	✓
Capacitive Reactive Power	M/kvarC			✓	✓	✓
Power factor	PF			✓	✓	✓
Cos φ	φ			✓	✓	✓
Voltage THD %	% THD V	✓(L1-L2)			✓	
Current THD %	% THD A	✓(L1)			✓	
Harmonic Breakdown - Voltage (up to the 17th harmonic)	harm V	✓(L1-L2)			✓	
Harmonic Breakdown - Current (up to the 17th harmonic)	harm A	✓(L1)			✓	
Active energy	M/kWh			✓		
Inductive Reactive Energy	M/kvarLh			✓		
Capacitive Reactive Energy	M/kvarCh			✓		
Apparent energy	M/kVAh			✓		
Temperature	°C			✓		
No. of operations	x1000			✓		
Total activated power	%			✓		

⁽⁵⁾ Displays the maximum value.







⁽⁶⁾ Displays the minimum value.

4.3.- KEY FUNCTIONS

The **Computer SMART III FAST** has 5 keys that can be used to browse the various screens and program the unit.

Key functions on the measurement screens (**Table 6**):







Table 6: Key functions on the measurement screens.

Key	Short press	Long press (3 s)
	Previous screen	-
	Next screen	-
	Display minimum value	Delete minimum values
	Display maximum value	Delete maximum values
	Next parameter	Enter the programming menu
 	Very long press (10 s.) Enter the Test screens	

Note: See “4.6.1. MEASUREMENT STATUS” for further details.

Key functions on the Configuration and Test screens, query mode (**Table 7**):





Table 7: Key functions on the Configuration and Test screens, query mode.

Key	Short press	Long press (3 s)
	Previous screen	Test: Manual connection of the selected capacitor
	Next screen	Test: Manual disconnection of the selected capacitor
	Previous parameter	
	Next parameter	
	Configuration: Edit mode Test: Start AutoTest	Test: Cancel the AutoTest process
 	Very long press (10 s.) Exit the Test screens	

Note: See “4.6.2. TEST STATUS” and “5.- CONFIGURATION” for further details.

Key functions on the Configuration and Test screens, editing mode (Table 8):

Table 8: Key functions on the Configuration and Test screens, edit mode.

Key	Short press
	Increase the value or show the next option.
	Reduce the value or show the previous option.
	Next configuration parameter
	Previous configuration parameter
	Exit Edit mode

Note: See “4.6.2. TEST STATUS” and “5.- CONFIGURATION” for further details.

4.4.- DISPLAY

The unit has a backlit LCD display.
The display is divided into four areas (Figure 12):

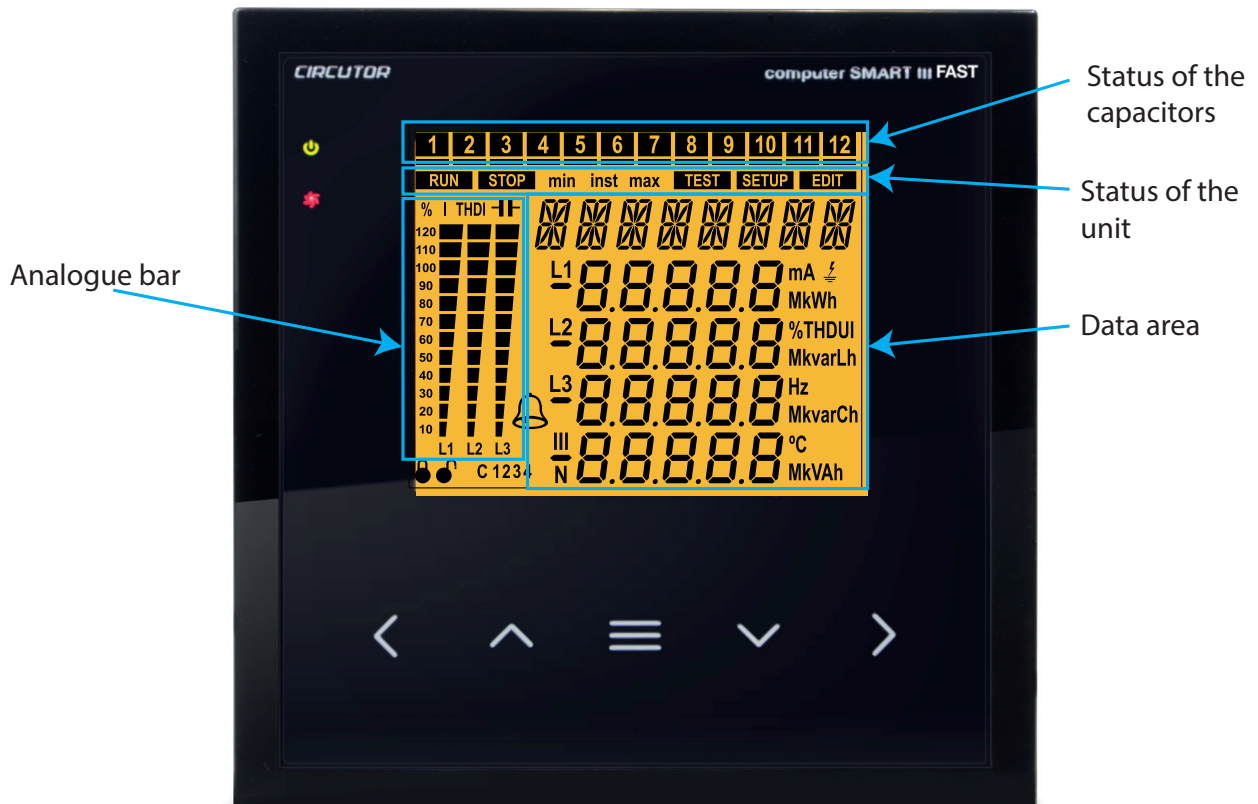

Figure 12: Areas of the Computer SMART III FAST display.

- ✓ The **data area**: displays the instantaneous, maximum and minimum values of each one of the phases which the unit is measuring or calculating.
- ✓ **Status of the capacitors**: displays the status of the unit's relays.
- ✓ **Status of the unit**: displays the current status of the unit.
- ✓ **Analogue bar**: configurable, shows the current, current THD or connected power of the capacitor bank as a percentage.



4.4.1. STATUS OF THE CAPACITORS



Figure 13: Status of the capacitors.

This area shows the status of the relays (stages) of the unit, and thus of the capacitors connected to it.

The possible states are:

- ✓ Nothing is displayed if the stage is not connected and configured as *AUT0*.
- ✓ The  icon is displayed if the stage is connected and configured as *AUT0*.
- ✓ The  icon is displayed with the bottom static bar if the stage is connected and configured as *ON*.
- ✓ The  icon is displayed with the bottom bar blinking if the stage is connected and configured as *ON AL*.
- ✓ Only the static bottom bar is displayed if the stage is disconnected and configured as *OFF*.
- ✓ Only the blinking bottom bar is displayed if the stage is cancelled by the leakage current alarm *E15*.





In the setup menu (“**5.12.- STATUS OF THE STAGES**”) the status of the stages is selected from the following options:

- ✓ *AUT0*: The status of the stage depends on the operation performed by the unit.
- ✓ *ON*: Stage forced to ON, always connected.
- ✓ *OFF*: Stage forced to OFF, always disconnected.
- ✓ *ON AL*: Stage forced to ON, always connected but the system does not take into account its connected power.

By default, all the stages are configured as *AUT0*.

4.4.2. STATUS OF THE UNIT

This area displays the status of the unit in accordance with the following icons:

-  **RUN** The unit is in measurement and regulation mode.
-  **STOP** The unit does not measure or regulate.
-  **SETUP** Indicates that you are in the setup menu.
-  **TEST** Indicates that you are in the test menu.
-  **EDIT** Indicates that, within the setup menu, you are in editing mode.

inst Indicates that you are viewing the instantaneous value.

max Indicates that you are viewing the maximum value.

min Indicates that you are viewing the minimum value.

4.4.3. ANALOGUE BAR

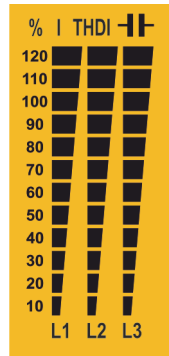

Figure 14: Analogue Bar

This bar is displayed on the measurement screens, and can show:

- ✓ the current of each phase as a percentage.
- ✓ the current THD of each phase.
- ✓ the power connected to the capacitor bank.

The parameter to be displayed is selected in the setup menu. (“5.14.- ANALOGUE BAR”)

The display screen also shows the results of the TEST and the load % of the capacitors.

4.4.4. OTHER SYMBOLS ON THE DISPLAY

The display also shows the following:

 **Alarm:** When the unit detects an alarm, the backlight of the display flashes and the alarm icon lights up. The cause of the alarm can be seen on the active alarms screen. (“4.6.- OPERATING STATES”)

 **Target cosine:** The icons indicate which one of the 4 possible target cosines has been selected. (“5.3.- TARGET COS φ ”)

 **Editing locked / unlocked:** The editing of the programming parameters is password protected. These icons indicate whether or not this option is locked.

4.5.- LED INDICATORS

The **Computer SMART III FAST** unit features:

- ✓ A **CPU** LED: Indicates that the unit is working properly by blinking once per second.
- ✓ An **Alarm** LED: Indicates that an alarm is activated.
- ✓ A **Fan** LED: Indicates that the fan is operating.
- ✓ A **key pressed** LED: Lights up when any of the 5 keys are pressed.

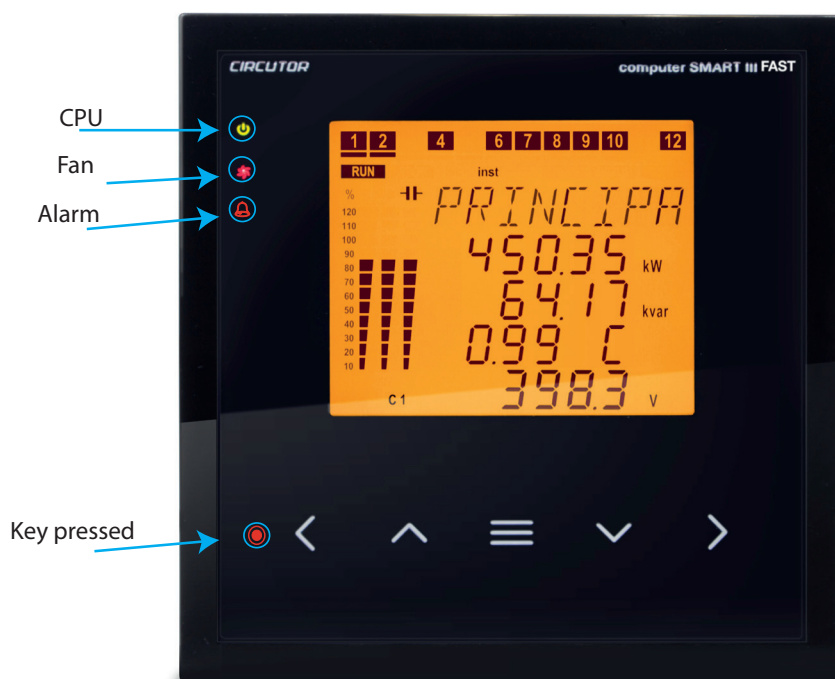

Figure 15:LED indicators of the Computer SMART III FAST.



4.6.- OPERATING STATES

The **Computer SMART III FAST** has 2 operating states with the display screens matching the selected status:

- ✓ Measurement status, **RUN**,
- ✓ Test status, **TEST**,

4.6.1. MEASUREMENT STATUS

This status is identified by the **RUN** symbol in the unit status area of the display (**Figure 12**). It is the normal operating status of the **Computer SMART III FAST**, in which the unit measures the various grid parameters and acts according to the configured parameters, connecting or disconnecting the capacitors from the capacitor bank.

Use keys  and  to browse the various screens.

Delete maximum values:

On the maximum value display screen, press the  key for more than 3 seconds.



Delete minimum values:

On the minimum value display screen, press the  key for more than 3 seconds.

If 5 minutes pass without any keys being pressed, the unit returns to the main screen.

The display screens vary according to the connection type of the installation.

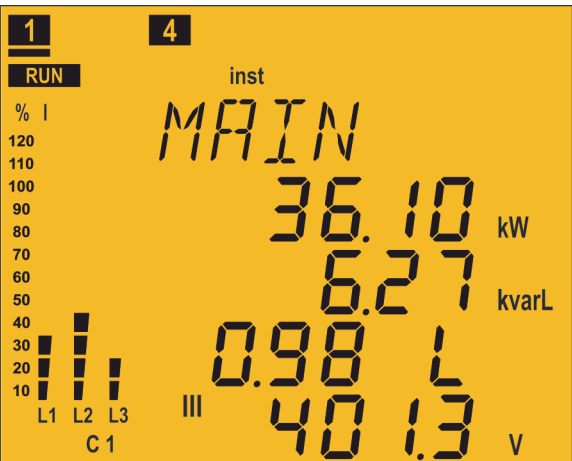
4.6.1.1. 3U.3C Connection (3 Voltages + Neutral and 3 currents)

Main Screen	Parameters
	<p>Active Power III(kW or MW) Reactive Power III(kvar or Mvar) Cos φ L: Inductive / C: capacitive +: consumed / -: generated Phase - Phase Voltage III(V or kV)</p> <p> Display the minimum values.  Display the maximum values.</p>

Press the  key to switch to the **Currents** screen.

Phase - Neutral Voltages	Parameters
	<p>L1 Phase - Neutral Voltage (V or kV) L2 Phase - Neutral Voltage (V or kV) L3 Phase - Neutral Voltage (V or kV) Phase - Neutral Voltage III(V or kV)</p> <p>◀ Display the minimum values. ▶ Display the maximum values.</p>

Phase - Phase Voltages	Parameters
	<p>L1 Phase - Phase Voltage (V or kV) L2 Phase - Phase Voltage (V or kV) L3 Phase - Phase Voltage (V or kV) Phase - Phase Voltage III(V or kV)</p> <p>◀ Display the minimum values. ▶ Display the maximum values.</p>

Currents	Parameters
	<p>L1 Current (A) L2 Current (A) L3 Current (A) N Current (A)</p> <p>◀ Display the minimum values. ▶ Display the maximum values.</p>

Press the or key to switch to the **Cosine ϕ** screen.

Cosine ϕ	Parameters
	<p>L1 Cos ϕ L2 Cos ϕ L3 Cos ϕ Cos ϕ III L: Inductive / C: capacitive +: Consumed / -: generated</p> <p> Display the minimum values. Display the maximum values.</p>

Press the key to switch to the **Energy III consumed** screen.

Power Factor	Parameters
	<p>L1 Power Factor L2 Power Factor L3 Power Factor Power Factor III L: Inductive / C: capacitive +: Consumed / -: generated</p> <p> Display the minimum values. Display the maximum values.</p>

Power III	Parameters
	<p>Active Power III(kW or MW) Inductive Reactive Power III (kvarL or MvarL) Capacitive Reactive Power III (kvarC or MvarC) Apparent Power III (kVA or MVA)</p> <p> Display the minimum values. Display the maximum values.</p>

Active Power	Parameters
	<p>L1 Active power (kW or MW) L2 Active power (kW or MW) L3 Active power (kW or MW) Active Power III(kW or MW)</p> <p>◀ Display the minimum values. ▶ Display the maximum values.</p>

Inductive Reactive Power	Parameters
	<p>L1 Inductive Reactive Power L2 Inductive Reactive Power L3 Inductive Reactive Power Inductive Reactive Power III (kvarL or MvarL)</p> <p>◀ Display the minimum values. ▶ Display the maximum values.</p>

Capacitive Reactive Power	Parameters
	<p>L1 Capacitive Reactive Power L2 Capacitive Reactive Power L3 Capacitive Reactive Power Capacitive Reactive Power III (kvarC or MvarC)</p> <p>◀ Display the minimum values. ▶ Display the maximum values.</p>

Apparent Power	Parameters
	<p>L1 Apparent Power L2 Apparent Power L3 Apparent Power Apparent Power III (kVA or MVA)</p> <p>◀ Display the minimum values. ▶ Display the maximum values.</p>

Leakage current / Frequency / Temperature	Parameters
	<p>Leakage current (mA) Frequency (Hz) Temperature (°C)</p> <p>◀ Display the minimum values. ▶ Display the maximum values.</p>

Voltage THD	Parameters
	<p>L1 Voltage THD L2 Voltage THD L3 Voltage THD (%)</p> <p>▶ Display the maximum values.</p>

Voltage harmonics	Parameters
	<p>L1 Voltage harmonic L2 Voltage harmonic L3 Voltage harmonic (%)</p> <p>☰ Change the harmonic no.: 3, 5, 7, 9, 11, 13, 15, 17.</p> <p>➤ Display the maximum values.</p>

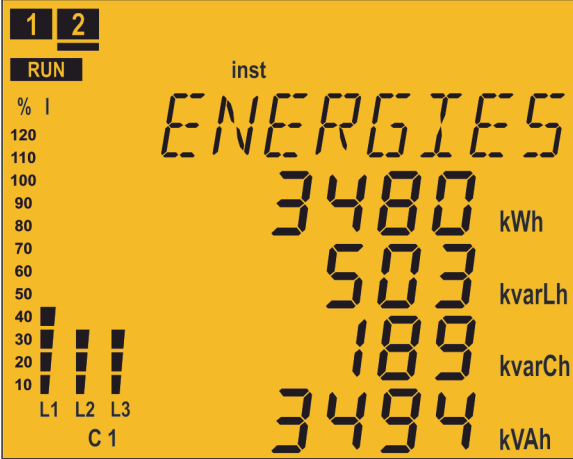

Current THD	Parameters
	<p>L1 Current THD L2 Current THD L3 Current THD (%)</p> <p>➤ Display the maximum values.</p>

Current harmonics	Parameters
	<p>L1 Current harmonic L2 Current harmonic L3 Current harmonic (%)</p> <p>☰ Change the harmonic no.: 3, 5, 7, 9, 11, 13, 15, 17.</p> <p>➤ Display the maximum values.</p>

Energy III consumed	Parameters
	<p>Active Energy III consumed (kWh or MWh)</p> <p>Inductive Reactive Energy III consumed (kvarLh or MvarLh)</p> <p>Capacitive Reactive Energy III consumed (kvarCh or MvarCh)</p> <p>Apparent Energy III consumed (kVAh or MVAh)</p>

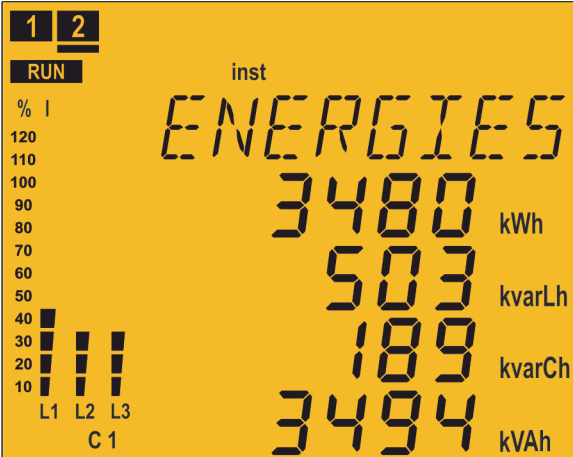
Press the  key to switch to the **Main** screen.

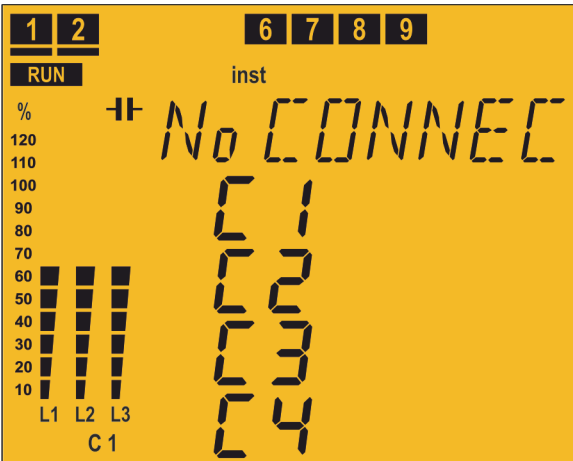
Energy III generated	Parameters
	<p>Active Energy III generated (kWh or MWh)</p> <p>Inductive Reactive Energy III generated (kvarLh or MvarLh)</p> <p>Capacitive Reactive Energy III generated (kvarCh or MvarCh)</p> <p>Apparent Energy III generated (kVAh or MVAh)</p>

Operations	Parameters
	<p>No. of operations of stage C1 to C12 Three screens show the number of operations of the 12 possible stages.</p> <p> for more than 3 seconds: delete the no. of operations.</p>

This parameter should be associated with an alarm that is activated when the number of operations exceeds a pre-determined value (for example, 5000 operations) in order to perform the maintenance of this stage.

There are thousands of operations, so the value displayed is in thousands of operations (which is the reason for the k icon).

Active alarms	Parameters
	<p>Active alarm code E01 to E017 (Table 9)</p> <p>If there are more than 4 alarms, the information is scrolled on the screen.</p>

Table 9: Alarm codes.

Code	Description
<i>E01</i>	<p>No current. The load current is lower than the minimum value or some of the current transformers (CT) are not connected. It is activated when the secondary current of the transformer is lower than 50 mA in some of the phases. The unit disconnects the capacitors automatically.</p>
<i>E02</i>	<p>Overcompensation. The unit measures capacitive power but all the stages are disconnected. This can be due to an incorrect adjustment of the C/K parameter. In order to avoid possible false actions, this alarm has a predefined delay of 90 seconds.</p>
<i>E03</i>	<p>Undercompensation. The unit measures inductive power but all the stages are disconnected. This can be due to an incorrect adjustment of the C/K parameter. In order to avoid possible false actions, this alarm has a predefined delay of 90 seconds.</p>
<i>E04</i>	<p>Overcurrent. The measured current exceeds the nominal current by +20 % in some of the phases. The nominal current is considered to be that of the CT primary. In order to avoid possible false actions, this alarm has a predefined delay of 5 seconds.</p>
<i>E05</i>	<p>Overvoltage. The voltage measured in some of the phases exceeds the configured voltage (Vp-n). The unit disconnects the capacitors automatically. In order to avoid possible false actions, this alarm has a predefined delay of 5 seconds.</p>
<i>E06</i>	<p>Low voltage. The voltage in some of the phases is lower than the configured voltage (Vp-n). The unit disconnects the capacitors automatically. In order to avoid possible false actions, this alarm has a predefined delay of 5 seconds.</p>
<i>E07</i>	<p>Cos ϕ alarm. The three-phase cos ϕ is lower than the limit configured in the Cos ϕ alarm. Also, the measured currents should be higher than the configured threshold. In order to avoid possible false actions, this alarm has a predefined delay of 15 seconds.</p>

Table 9 (Continuation): Alarm codes.

Code	Description
<i>E08</i> ⁽⁷⁾	Voltage THD Alarm. The Voltage THD levels in some of the phases are higher than those configured in the Voltage THD alarm.
<i>E09</i> ⁽⁷⁾	Current x I THD Alarm. The IxITHD levels in some of the phases are higher than those configured in the IxITHD alarm. (IxITHD refers to the multiplication of the current by the ITHD of the same current, see "5.23.- CURRENT x I THD ALARM")
<i>E10</i> ⁽⁷⁾	Temperature Alarm. The measured temperature is higher than that configured in the Temperature alarm.
<i>E11</i>	No Connection Status due to <i>E08</i> , <i>E09</i> or <i>E10</i> .
<i>E12</i>	Disconnection Status due to <i>E08</i> , <i>E09</i> or <i>E10</i> .
<i>E13</i>	Leakage Alarm. The leakage current is higher than that configured in the Leakage Current alarm.
<i>E14</i>	Repeated Leakage Alarm. Leakages have been detected repeatedly in the system, but they are not caused by a capacitor.
<i>E15</i>	Leakage in Capacitors Alarm. Leakages have been detected, which were caused by some of the capacitors, and this stage is disabled. The disabled capacitors will start to blink on the screen. The <i>E13</i> message will also be displayed. In order to enable these capacitors again, view the configuration of the Leakage alarm.
<i>E16</i>	Leakage transformer detection Alarm. The Leakage alarm has been enabled, but the unit does not detect the connection of the leakage current transformer.
<i>E17</i>	Number of connections alarm. The configured number of operations has been exceeded (any capacitor)

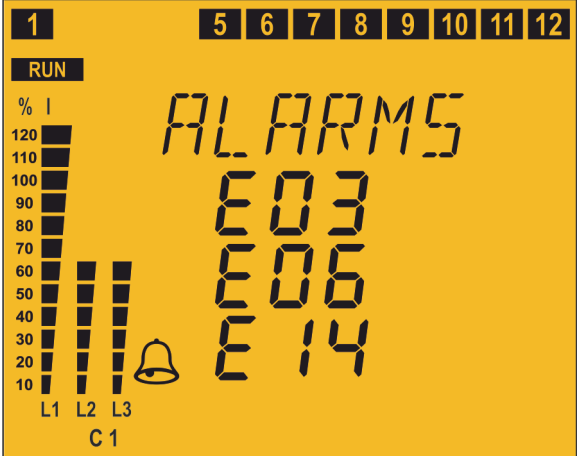
⁽⁷⁾ In these alarms, two levels have been configured:

✓ The *L₀* **value**: When the unit exceeds this value for 30 minutes, the corresponding alarm is triggered and, if alarm *E 11* is enabled, the **SMART III FAST** unit enters **No Connection** status and activates alarm *E 11*.

✓ The *H_i* **value** : if the unit exceeds this value for 30 seconds, the corresponding alarm is triggered and, if alarm *E 12* is enabled, the **SMART III FAST** unit enters **Disconnection** status and activates alarm *E 12*.

If the unit falls back under the *L₀* value for 10 minutes, it deactivates the alarms and returns to the normal operating status.

In the **No Connection** status, the unit does not connect the stages, but also does not disconnect them if the operation requires it.

In the **Disconnection** status, it disconnects the stages and does not allow them to connect.

4.6.1.2. 3U. IC Connection (3 Voltages + Neutral and 1 current)

Main Screen	Parameters
	<p>Active Power III(kW or MW) Reactive Power III(kvar or Mvar) +: inductive / -: capacitive Cos φ L: Inductive / C: capacitive +: consumed / -: generated Phase - Phase Voltage III(V or kV)</p> <p>◀ Display the minimum values. ▶ Display the maximum values.</p>

Press the key to switch to the **Currents** screen.

Phase - Neutral Voltages	Parameters
	<p>L1 Phase - Neutral Voltage (V or kV) L2 Phase - Neutral Voltage (V or kV) L3 Phase - Neutral Voltage (V or kV) Phase - Neutral Voltage III(V or kV)</p> <p>◀ Display the minimum values. ▶ Display the maximum values.</p>

Phase - Phase Voltages	Parameters
	<p>L1 Phase - Phase Voltage (V or kV) L2 Phase - Phase Voltage (V or kV) L3 Phase - Phase Voltage (V or kV) Phase - Phase Voltage III(V or kV)</p> <p>◀ Display the minimum values. ▶ Display the maximum values.</p>

Currents	Parameters
	<p>Current (A)</p> <p> <input type="checkbox"/> Display the minimum values. <input type="checkbox"/> Display the maximum values. </p>

Press the or key to switch to the **Cosine φ** screen.

Cosine φ	Parameters
	<p>Cos φ L: Inductive / C: capacitive +: consumed / -: generated</p> <p> <input type="checkbox"/> Display the minimum values. <input type="checkbox"/> Display the maximum values. </p>



Press the key to switch to the **Energy III consumed** screen.



Power Factor	Parameters
	<p>Power factor L: Inductive / C: capacitive +: consumed / -: generated</p> <p> <input type="checkbox"/> Display the minimum values. <input type="checkbox"/> Display the maximum values. </p>

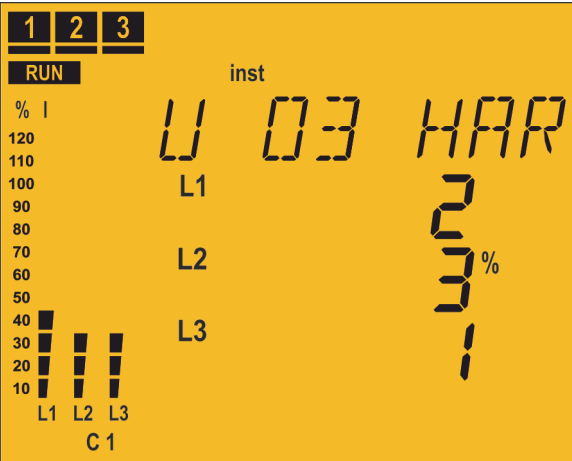

Power III	Parameters
<p>The screenshot shows a yellow background with a vertical scale on the left from 10 to 120. At the top, '7 8 9' is displayed. Below that, 'RUN' and 'inst' are shown. The main display reads 'POWER III'. The values are: 35.54 kW, 6.28 kvarL, 0.00 kvarC, and 36.13 kVA. On the left, there are three bar graphs for L1, L2, and L3, and 'C 1' at the bottom.</p>	<p>Active Power III(kW or MW) Inductive Reactive Power III (kvarL or MvarL) Capacitive Reactive Power III (kvarC or MvarC) Apparent Power III (kVA or MVA)</p> <p>◀ Display the minimum values. ▶ Display the maximum values.</p>

Leakage current / Frequency / Temperature	Parameters
<p>The screenshot shows a yellow background with a vertical scale on the left from 10 to 120. At the top, '1 2' is displayed. Below that, 'RUN' and 'inst' are shown. The main display reads 'I LEAK / F'. The values are: 30 mA, 50.0 Hz, and 35.8 °C. On the left, there are three bar graphs for L1, L2, and L3, and 'C 1' at the bottom.</p>	<p>Leakage current (mA) Frequency (Hz) Temperature (°C)</p> <p>◀ Display the minimum values. ▶ Display the maximum values.</p>

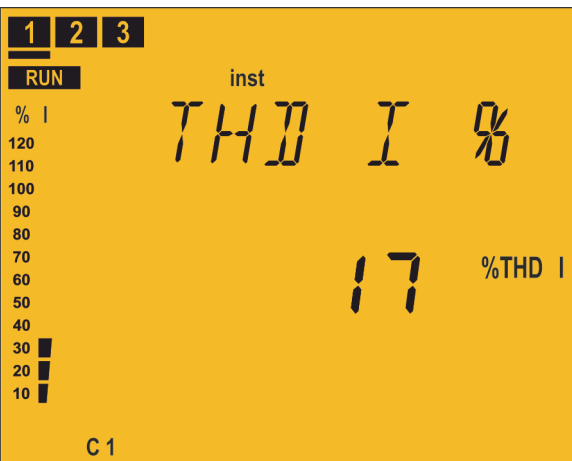
Voltage THD	Parameters
<p>The screenshot shows a yellow background with a vertical scale on the left from 10 to 120. At the top, '1 2 3' is displayed. Below that, 'RUN' and 'inst' are shown. The main display reads 'THD U %'. The values are: L1 18, L2 15, and L3 16. On the left, there are three bar graphs for L1, L2, and L3, and 'C 1' at the bottom.</p>	<p>L1 Voltage THD L2 Voltage THD L3 Voltage THD (%)</p> <p>▶ Display the maximum values.</p>

Voltage harmonics	Parameters
	<p>L1 Voltage harmonic L2 Voltage harmonic L3 Voltage harmonic (%)</p> <p> Change the harmonic no.: 3, 5, 7, 9, 11, 13, 15, 17.</p> <p> Display the maximum values.</p>

Current THD	Parameters
	<p>Current THD (%)</p> <p> Display the maximum values.</p>

Current harmonics	Parameters
	<p>Current harmonic (%)</p> <p> Change the harmonic no.: 3, 5, 7, 9, 11, 13, 15, 17.</p> <p> Display the maximum values.</p>

Energy III consumed	Parameters
	<p>Active Energy III consumed (kWh or MWh)</p> <p>Inductive Reactive Energy III consumed (kvarLh or MvarLh)</p> <p>Capacitive Reactive Energy III consumed (kvarCh or MvarCh)</p> <p>Apparent Energy III consumed (kVAh or MVAh)</p>

Press the key to switch to the **Main** screen.

Energy III generated	Parameters
	<p>Active Energy III generated (kWh or MWh)</p> <p>Inductive Reactive Energy III generated (kvarLh or MvarLh)</p> <p>Capacitive Reactive Energy III generated (kvarCh or MvarCh)</p> <p>Apparent Energy III generated (kVAh or MVAh)</p>



Operations	Parameters
	<p>No. of operations of stage C1 to C12 Three screens show the number of operations of the 12 possible stages.</p> <p> for more than 3 seconds: delete the no. of operations.</p>

This parameter should be associated with an alarm that is activated when the number of operations exceeds a pre-determined value (for example, 5000 operations) in order to perform the maintenance of this stage.

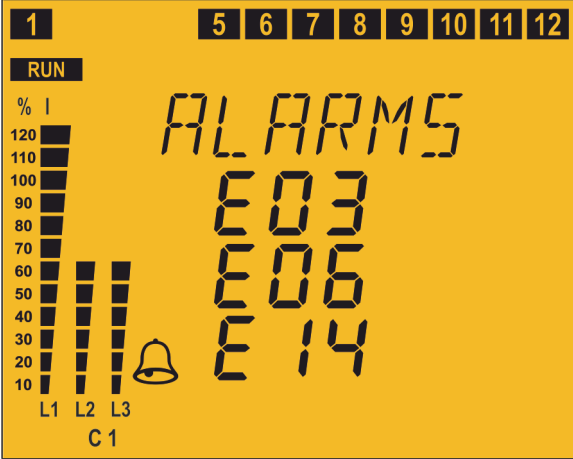

There are thousands of operations, so the value displayed is in thousands of operations (which is the reason for the k icon).

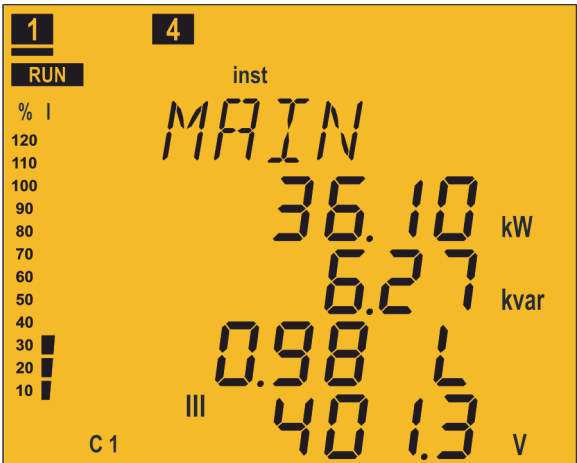

Active alarms	Parameters
	<p>Active alarm code E01 to E017 (Table 9). If there are more than 4 alarms, the information is scrolled on the screen.</p>



4.6.1.3. 2U. IC Connection (2 Voltages and 1 current)

Main Screen	Parameters
	<p>Active Power III(kW or MW) Reactive Power III(kvar or Mvar) +: inductive / -: capacitive Cos φ L: Inductive / C: capacitive +: consumed / -: generated Phase - Phase Voltage (V or kV)</p> <p> Display the minimum values.  Display the maximum values.</p>

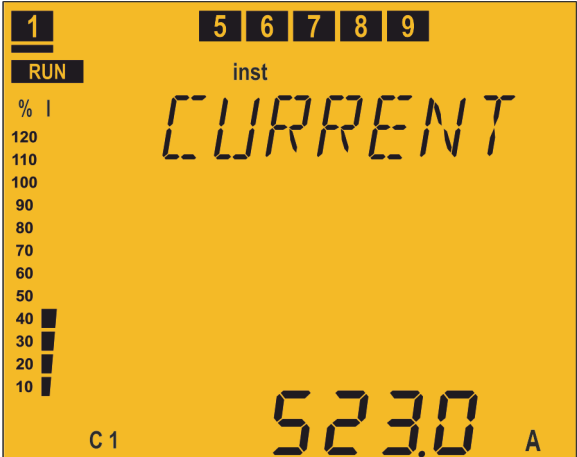
Press the  key to switch to the **Currents** screen.

Phase - Phase Voltages	Parameters
	<p>Phase - Phase Voltage (V or kV)</p> <p> Display the minimum values.  Display the maximum values.</p>

Currents	Parameters
	<p>Current (A)</p> <p> Display the minimum values.  Display the maximum values.</p>

Press the  or  key to switch to the **Cosine φ** screen.

Cosine φ	Parameters
	<p>Cos φ L: Inductive / C: capacitive +: consumed / -: generated</p> <p> Display the minimum values. Display the maximum values.</p>

Press the key to switch to the **Energy III consumed** screen.



Power Factor	Parameters
	<p>Power factor L: Inductive / C: capacitive +: consumed / -: generated</p> <p> Display the minimum values. Display the maximum values.</p>



Power III	Parameters
	<p>Active Power III(kW or MW) Inductive Reactive Power III (kvarL or MvarL) Capacitive Reactive Power III (kvarC or MvarC) Apparent Power III (kVA or MVA)</p> <p> Display the minimum values. Display the maximum values.</p>

Leakage current / Frequency / Temperature	Parameters
	<p>Leakage current (mA) Frequency (Hz) Temperature (°C)</p> <p>◀ Display the minimum values. ▶ Display the maximum values.</p>

Voltage THD	Parameters
	<p>Voltage THD (%)</p> <p>▶ Display the maximum values.</p>

Voltage harmonics	Parameters
	<p>Voltage harmonic (%)</p> <p>☰ Change the harmonic no.: 3, 5, 7, 9, 11, 13, 15, 17. ▶ Display the maximum values.</p>

Current THD	Parameters
	<p>Current THD (%)</p> <p> Display the maximum values.</p>

Current harmonics	Parameters
	<p>Current harmonic (%)</p> <p> Change the harmonic no.: 3, 5, 7, 9, 11, 13, 15, 17.</p> <p> Display the maximum values.</p>

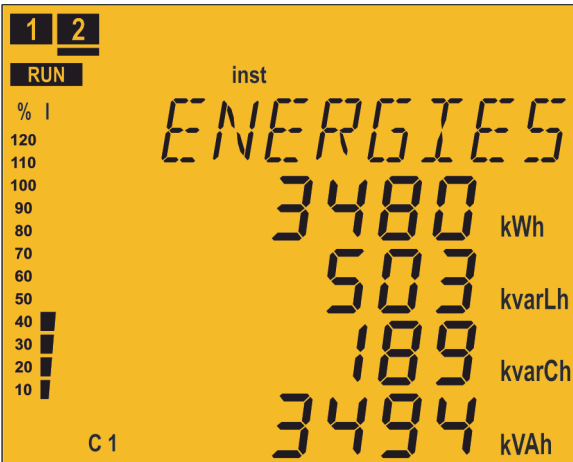
Energy III consumed	Parameters
	<p>Active Energy III consumed (kWh or MWh)</p> <p>Inductive Reactive Energy III consumed (kvarLh or MvarLh)</p> <p>Capacitive Reactive Energy III consumed (kvarCh or MvarCh)</p> <p>Apparent Energy III consumed (kVAh or MVAh)</p>

Press the  key to switch to the **Main** screen.

Energy III generated	Parameters
	<p>Active Energy III generated (kWh or MWh)</p> <p>Inductive Reactive Energy III generated (kvarLh or MvarLh)</p> <p>Capacitive Reactive Energy III generated (kvarCh or MvarCh)</p> <p>Apparent Energy III generated (kVAh or MVAh)</p>

Operations	Parameters
	<p>No. of operations of stage C1 to C12 Three screens show the number of operations of the 12 possible stages.</p> <p> for more than 3 seconds: delete the no. of operations.</p>



This parameter should be associated with an alarm that is activated when the number of operations exceeds a pre-determined value (for example, 5000 operations) in order to perform the maintenance of this stage.
There are thousands of operations, so the value displayed is in thousands of operations (which is the reason for the k icon).



Active alarms	Parameters
	<p>Active alarm code E01 to E017 (Table 9) If there are more than 4 alarms, the information is scrolled on the screen.</p>



4.6.2. TEST STATUS

This status is identified by the **TEST** symbol in the unit status area of the display (**Figure 12**).





The stages can be connected and disconnected manually, and the measured parameters that relate to each one of the stages can be displayed. It also comprises the AutoTest function, which scans and calculates all the stages of the unit.

A very long press (> 10s) of the   key in any of the measurement screens causes the unit to enter the Test status.

A very long press (> 10s) of the   key in any of the test screens causes the unit to return to the Measurement status.



Use keys  and  to browse the various screens.

If 5 minutes pass without any keys being pressed, the unit returns to the main screen.

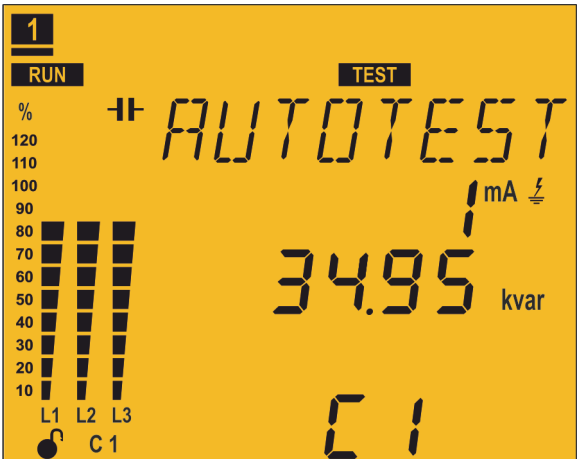
Disconnection screen	Parameters
	<p>Transition screen: used for the unit to disconnect all the stages automatically before entering Test status.</p> <p>While in this screen, the unit does not respond to the keys.</p> <p>The unit automatically exits this screen, and this can take a certain amount of time.</p>
AutoTest	Parameters
	<p>AutoTest home screen.</p> <p>To start the AutoTest:</p> <p>Press the  key, <i>OFF</i> blinks.</p> <p>Press the  key to switch from <i>OFF</i> to <i>Start</i></p> <p>Press the  key to start the AutoTest</p>

	<p>Once the AutoTest has started, the results of the capacitors that are connected and disconnected are shown:</p> <ul style="list-style-type: none"> Leakage current (mA) Capacitive Reactive Power (kvarC or MvarC) Capacitive Power % of each capacitor relative to the total estimated value. <p>The RUN icon blinks during the AutoTest.</p>
---	--

A long press (> 3 s) of the  key cancels the AutoTest. At the end of the AutoTest, the unit automatically returns to the Individual Test screen.

Individual Test	Parameters
	<ul style="list-style-type: none"> Leakage current (mA) Capacitive Reactive Power (kvarC or MvarC) Capacitive Power % of each capacitor relative to the total estimated value. <p>  Switches between the various capacitors.</p>

A long press (> 3 s) of the  key connects the capacitor that is being displayed, taking into account the programmed connection and reconnection times.

A long press (> 3 s) of the  key disconnects the capacitor that is being displayed, taking into account the programmed connection and reconnection times.

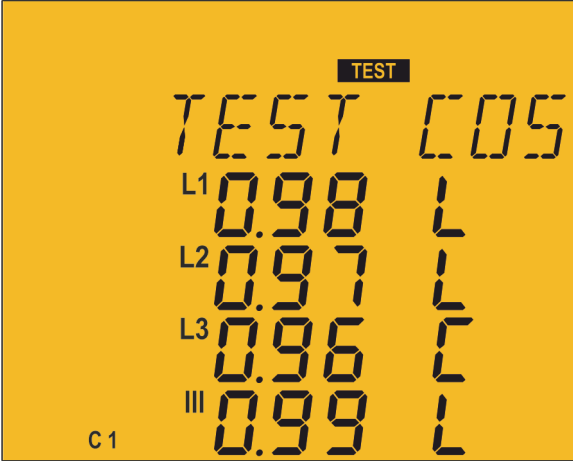
Cosine ϕ test	Parameters
	<p>Display screen of the: Cos ϕ (2U.1C and 3U.1C connection)</p> <p>L1 Cos ϕ (3U.3C connection) L2 Cos ϕ (3U.3C connection) L3 Cos ϕ (3U.3C connection) Cos ϕ III(3U.3C connection)</p> <p>L: Inductive / C: capacitive +: consumed / -: generated</p>

Current THD Test	Parameters
	<p>Display screen of the: Current THD (2U.1C and 3U.1C connection)</p> <p>L1 Current THD (3U.3C connection) L2 Current THD (3U.3C connection) L3 Current THD (3U.3C connection)</p>

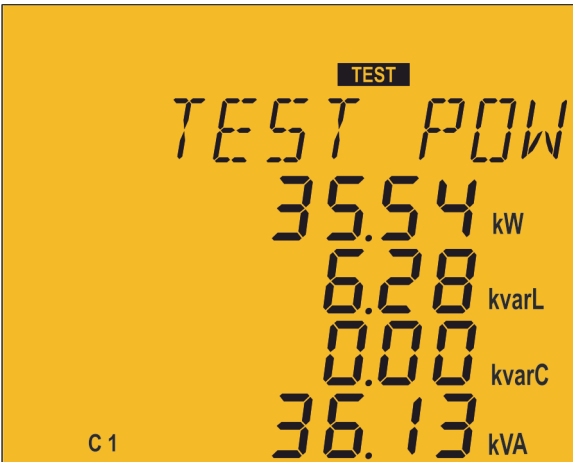
Power III Test	Parameters
	<p>Display screen of the:</p> <p>Active Power III(kW or MW) Inductive Reactive Power III (kvarL or MvarL) Capacitive Reactive Power III (kvarC or MvarC) Apparent Power III (kVA or MVA)</p>

4.7.- INPUTS

The **Computer SMART III FAST** comprises two digital inputs (terminals 31 and 32 of **Figure 2**) for activating any of the four **target cos φ** , in other words, the desired power factor for the installation, which can be programmed in the unit. See “**5.3.- TARGET COS φ** ”

Table 10: Selection of the target cos φ .

Digital input 2	Digital Input 1	Target cos φ
0	0	1
0	1	2
1	0	3
1	1	4

On the display, the C 1234 icon indicates which of the 4 possible target cosines was selected.

4.8.- OUTPUTS

The unit features:

- ✓ A relay (terminals 37 and 38 of **Figure 2**) dedicated to activating a fan when a pre-determined temperature is exceeded, which can be programmed in “**5.15.- FAN**”, is also connected to the **Fan LED**.
- ✓ A fully programmable alarm relay (terminals 39, 40 and 41 of **Figure 2**), see “**5.19.- ENABLING ALARMS**”
- ✓ Two digital outputs, fully programmable optoisolated NPN transistors (terminals 34, 35 and 36 of **Figure 2**), see “**5.19.- ENABLING ALARMS**”

Computer SMART III FAST 6 model:

- ✓ Six optoMOS relay outputs (terminals 15 ...21 of **Figure 2**) for the regulation of cos φ via capacitors.

Computer SMART III FAST 12 model:

- ✓ Twelve optoMOS relay outputs (terminals 15 ...27 of **Figure 2**) for the regulation of cos φ via capacitors.

4.9.- RS-485 COMMUNICATIONS

Computer SMART III FAST units have an RS-485 serial communication output with the Modbus RTU® communications protocol

4.9.1. CONNECTIONS

The RS -485 cable should be wired with a twisted pair cable with mesh shield (minimum 3 wires), with a maximum distance between the Computer SMART III FAST and the master unit of 1,200 metres.

A maximum of 32 Computer SMART III FAST units can be connected to this bus.

Use an intelligent RS-232 to RS-485 network protocol converter (M54020 intelligent converter) to establish the communications with the master unit. This converter does away with the need for the Pin 7 connection on the RS-485 side.

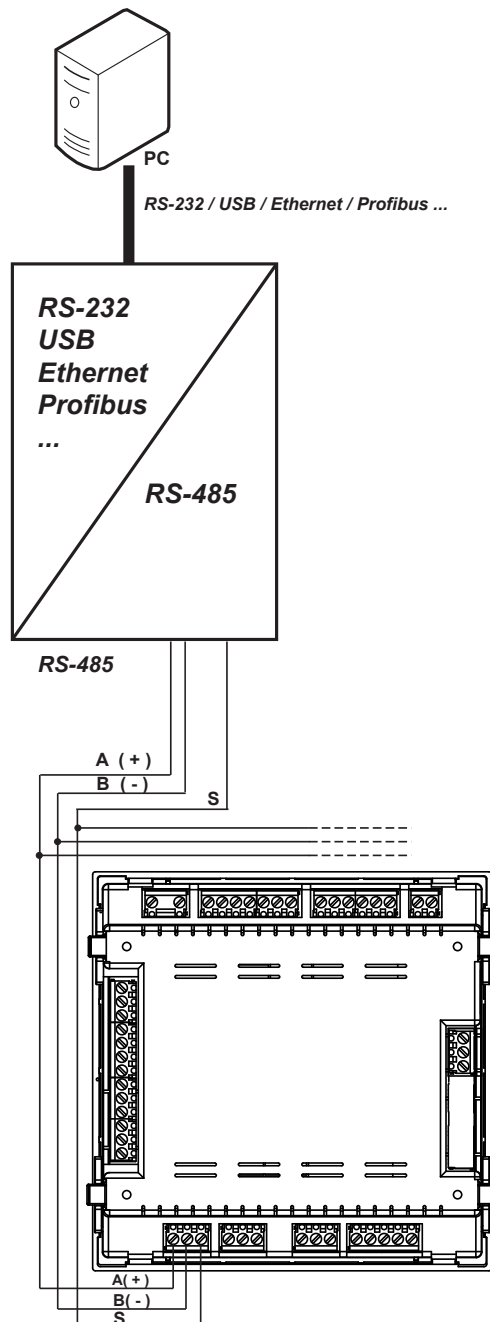

Figure 16: RS-485 Connection diagram.

4.9.2. PROTOCOL

The Modbus protocol is an industry communication standard which enables networking of multiple units, with one master and several slaves. It allows individual master-slave dialogue and also enables commands in broadcast format.

In the Modbus protocol, the **Computer SMART III FAST** unit uses the RTU (Remote Terminal Unit) mode.

In the RTU mode, the message start and end are detected with silences of at least 3.5 characters, and the 16-bit CRC error-detection method is used.

The Modbus functions implemented in the unit are as follows:

Function 01. Reading the status of the relays.

Functions 03 and 04. Reading logs.

Function 05. Writing a relay.

Function 0F. Writing multiple relays.

Function 10. Writing multiple logs.

Exception codes

If the bit with greatest weight of the byte corresponding to the function in the reply of the unit is 1, this indicates that the next byte is an exception code.

Table 11: Exception codes, Modbus communications.

Exception code	Description
01	Incorrect function. The function number is not implemented.
02	Incorrect address or number of logs out of limits
03	Data error. A CRC error has occurred
04	Peripheral error. An error occurred when accessing a peripheral (EEPROM, card, etc.)
06	Slave error or Slave busy. Retry sending.

Example:

Address	Function	Exception code	CRC
0A	84	01	XXXX

Address: 0A, Peripheral number: 10 in decimal.

Function: 84, Reading function 04 with bit no. 7 at 1.

Exception code: 01, see Table 9.

CRC: 16-bit CRC.



For reasons of operational security of the unit, communication frames of more than 80 bytes are not accepted (sent or received).

4.9.3. MODBUS MEMORY MAP

A.- Measurement Variables

For these variables **Function 04** is implemented: reading logs.
The Modbus addresses of all the tables are hexadecimal.

Table 12: Modbus memory map: measurement variables (Table 1)

Parameter	Instantaneous	Maximum	Minimum	Units
L1 Phase voltage	00-01	200-201	300-301	V/100
L1 Current	02-03	202-203	302-303	mA
L1 Active power	04-05	204-205	304-305	W
L1 Inductive Reactive Power	06-07	206-207	306-307	varL
L1 Capacitive Reactive Power	08-09	208-209	308-309	varC
L1 Reactive power	0A-0B	20A-20B	30A-30B	var
L1 Apparent power	0C-0D	20C-20D	30C-30D	VA
L1 Reactive Power Consumed	0E-0F	20E-20F	30E-30F	var
L1 Reactive Power Generated	10-11	210-211	310-311	var
L1 Power Factor ⁽⁸⁾	12-13	212-213	312-313	-
L1 Cos φ ⁽⁸⁾	14-15	214-215	314-315	-
L1 kW sign ⁽⁸⁾	16-17	-	-	+1 or -1
L1 kvar sign ⁽⁸⁾	18-19	-	-	+1 or -1
L2 Phase voltage	1A-1B	21A-21B	31A-31B	V/100
L2 Current	1C-1D	21C-21D	31C-31D	mA
L2 Active power	1E-1F	21E-21F	31E-31F	W
L2 Inductive Reactive Power	20-21	220-221	320-321	varL
L2 Capacitive Reactive Power	22-23	222-223	322-323	varC
L2 Reactive Power	24-25	224-225	324-325	var
L2 Apparent Power	26-27	226-227	326-327	VA
L2 Reactive Power Consumed	28-29	228-229	328-329	var
L2 Reactive Power Generated	2A-2B	22A-22B	32A-32B	var
L2 Power Factor ⁽⁸⁾	2C-2D	22C-22D	32C-32D	-
L2 Cos φ ⁽⁸⁾	2E-2F	22E-22F	32E-32F	-
L2 kW sign ⁽⁸⁾	30-31	-	-	+1 or -1
L2 kvar sign ⁽⁸⁾	32-33	-	-	+1 or -1
L3 Phase voltage	34-35	234-235	334-335	V/100
L3 Current	36-37	236-237	336-337	mA
L3 Active Power	38-39	238-239	338-339	W
L3 Inductive Reactive Power	3A-3B	23A-23B	33A-33B	varL
L3 Capacitive Reactive Power	3C-3D	23C-23D	33C-33D	varC
L3 Reactive Power	3E-3F	23E-23F	33E-33F	var
L3 Apparent Power	40-41	240-241	340-341	VA
L3 Reactive Power Consumed	42-43	242-243	342-343	var
L3 Reactive Power Generated	44-45	244-245	344-345	var
L3 Power Factor ⁽⁸⁾	46-47	246-247	346-347	-
L3 Cos φ ⁽⁸⁾	48-49	248-249	348-349	-
L3 kW sign ⁽⁸⁾	4A-4B	-	-	+1 or -1
L3 kvar sign ⁽⁸⁾	4C-4D	-	-	+1 or -1

Table 12 (Continuation): Modbus memory map: measurement variables (Table 1)

Parameter	Instantaneous	Maximum	Minimum	Units
Three-phase voltage	4E-4F	24E-24F	34E-34F	V/100
Three-phase current	50-51	250-251	350-351	mA
Three-phase active power	52-53	252-253	352-353	W
Three-phase inductive power	54-55	254-255	354-355	varL
Three-phase capacitive power	56-57	256-257	356-357	varC
Three-phase reactive power	58-59	258-259	358-359	var
Three-phase apparent power	5A-5B	25A-25B	35A-35B	VA
Three-phase reactive power consumed	5C-5D	25C-25D	35C-35D	var
Three-phase reactive power generated	5E-5F	25E-25F	35E-35F	var
Three-phase power factor ⁽⁸⁾	60-61	260-261	360-361	-
Three-phase cos ϕ ⁽⁸⁾	62-63	262-263	362-363	-
Three-phase kW sign ⁽⁸⁾	64-65	-	-	-
Three-phase kvar sign ⁽⁸⁾	66-67	-	-	-
Frequency	68-69	268-269	368-369	Hz/10
L1-L2 Voltage	6A-6B	26A-26B	36A-36B	V/100
L2-L3 Voltage	6C-6D	26C-26D	36C-36D	V/100
L3-L1 Voltage	6E-6F	26E-26F	36E-36F	V/100
Neutral current	70-71	270-271	370-371	mA
Leakage Current	72-73	272-273	372-373	mA
Temperature	74-75	274-275	374-375	°C/10
L1 voltage THD %	7C-7D	27C-27D	-	%
L2 Voltage THD %	7E-7F	27E-27F	-	%
L3 Voltage THD %	80-81	280-281	-	%
L1 Current THD %	82-83	282-283	-	%
L2 Current THD %	84-85	284-285	-	%
L3 Current THD %	86-87	286-287	-	%
Active energy consumed kWh	88-89	-	-	kWh
Active energy consumed Wh	8A-8B	-	-	Wh
Inductive energy consumed kvarLh	8C-8D	-	-	kvarLh
Inductive energy consumed varLh	8E-8F	-	-	varLh
Capacitive energy consumed kvarCh	90-91	-	-	kvarCh
Capacitive energy consumed varCh	92-93	-	-	varCh
Apparent energy consumed kVAh	94-95	-	-	kVAh
Apparent energy consumed VAh	96-97	-	-	VAh
Active energy consumed kWh	98-99	--	-	kWh
Active energy consumed Wh	9A-9B	-	-	Wh
Inductive energy generated kvarLh	9C-9D	-	-	kvarLh
Inductive energy generated varLh	9E-9F	-	-	varLh
Capacitive energy generated kvarCh	A0-A1	-	-	kvarCh
Capacitive energy generated varCh	A2-A3	-	-	varCh
Apparent energy generated kVAh	A4-A5	-	-	kVAh
Apparent energy generated VAh	A6-A7	-	-	VAh

⁽⁸⁾ The **cos ϕ** and **Power factor** parameters are accompanied by the **kW sign** and **kva sign** parameters, which are used to determine the quadrant in which each phase is being measured. See **Figure 17**.

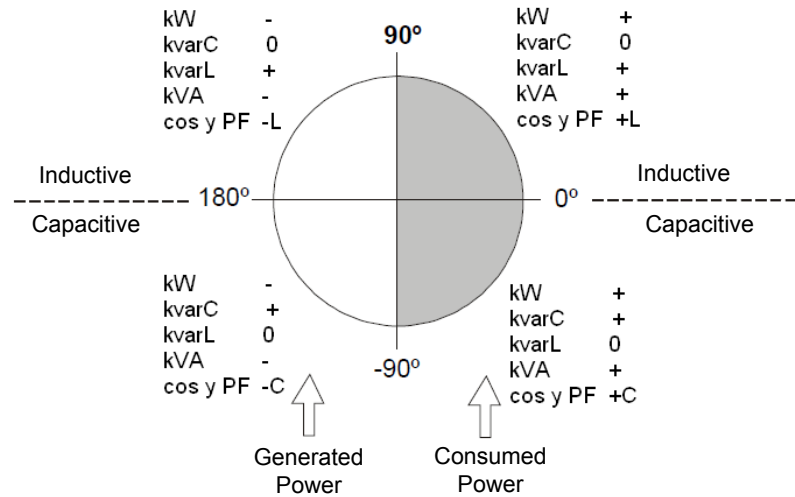

Figure 17: Diagram of the four measurement and compensation quadrants.

Table 13: Modbus memory map: measurement variables (Table 2)

Parameter	Instantaneous	Maximum	Units
L1 Fundamental Voltage Harmonic	400-401	484-485	V/100
L1 Voltage Harmonics	402-415	486-499	% / 10
L2 Fundamental Voltage Harmonic	416-417	49A-49B	mA
L2 Voltage Harmonics	418-42B	49C-4AF	% / 10
L3 Fundamental Voltage Harmonic	42C-42D	4B0-4B1	mA
L3 Voltage Harmonics	42E-441	4B2-4C5	% / 10
L1 Fundamental Current Harmonic	442-443	4C6-4C7	mA
L1 Current Harmonics	444-457	4C8-4DB	% / 10
L2 Fundamental Current Harmonic	458-459	4DC-4DD	mA
L2 Current Harmonics	45A-46D	4DE-4F1	% / 10
L3 Fundamental Current Harmonic	46E-46F	4F2-4F3	mA
L3 Current Harmonics	470-483	4F4-507	% / 10

Table 14: Modbus memory map: measurement variables (Table 3)

Parameter	Instantaneous
Relay variable	600
Alarm variable	605-606
Status of the outputs	610
Status of the digital inputs	615
No. of connections, of each of the 12 outputs (6 in the Computer SMART III FAST 6 model)	625-63C

✓ OptoMOS relay outputs variable

Shows the status of the 12 (**Computer SMART III FAST 12** model) or 6 (**Computer SMART III FAST 6** model) optoMOS relay outputs.

It is a 16-bit variable in which each bit indicates the status of an output.

	Bit 15-14-13-12	Bit 11	Bit 10	Bit 9	Bit 8	Bit 7	Bit 6	Bit 5	Bit 4	Bit 3	Bit 2	Bit 1	Bit 0
Relay	-	12	11	10	9	8	7	6	5	4	3	2	1

Where **0**: disconnected output (OFF).

1: connected output (ON).

✓ Alarm Variable

Shows the status of the 17 possible alarms.

It is a 32-bit variable in which each bit indicates the status of an alarm.

Bit 15	Bit 14	Bit 13	Bit 12	Bit 11	Bit 10	Bit 9	Bit 8	Bit 7	Bit 6	Bit 5	Bit 4	Bit 3	Bit 2	Bit 1	Bit 0
E16	E15	E14	E13	E12	E11	E10	E09	E08	E07	E06	E05	E04	E03	E02	E01

Bit 32	Bit 31	Bit 30	Bit 29	Bit 28	Bit 27	Bit 26	Bit 25	Bit 24	Bit 23	Bit 22	Bit 21	Bit 20	Bit 19	Bit 18	Bit 16
-	-	-	-	-	-	-	-	-	-	-	-	-	-	-	E17

Where **0**: alarm off (OFF).

1: alarm active (ON).

✓ Status of the outputs

Shows the status of the 4 outputs: Fan relay, alarm relay and the two digital outputs.

It is a 16-bit variable in which each bit indicates the status of an output.

Bit 15... 4	Bit 3	Bit 2	Bit 1	Bit 0
-	Digital output 2	Digital output 1	Alarm relay	Fan relay
-	1: OFF 0: ON	1: OFF 0: ON	1: ON 0: OFF	1: ON 0: OFF

✓ Status of the digital inputs

Shows the status of the 2 digital inputs.

It is a 16-bit variable in which each bit indicates the status of an input.

Bit 15 to 2	Bit 1	Bit 0
-	Digital input 2	Digital input 1
-	1: ON 0: OFF	1: ON 0: OFF

B.- Programming variables

The following functions are implemented for these variables:

Function 04: reading logs.

Function 10: Writing multiple logs.

Table 15: Modbus memory map: programming variables (Table 1)

Unit parameters	
Configuration variable	Address
Serial number ⁽⁹⁾	1000-1003
Frame number ⁽⁹⁾	1010-1013
Version ⁽⁹⁾	1020-1021
Hardware log ⁽⁹⁾	1030-1033

⁽⁹⁾ The parameters of the unit have only implemented **function 04**.

Table 16: Modbus memory map: programming variables (Table 2)

RS-485 Communications			
Configuration variable	Address	Valid data margin	Default value
Peripheral no.	1071	1 to 254	1
Speed	1072	0 (9600), 1 (19200)	1
Parity	1073	0 (none), 1 (odd), 2 (even)	0
Length	1074	0 (8 bits), 1 (7 bits)	0
Stop bits	1075	0 (1 bits), 1 (2 bits)	0

Table 17: Modbus memory map: programming variables (Table 3)

CPC-NET communications			
Configuration variable	Address	Valid data margin	Default value
Speed	1082	0 (9600), 1(19200), 2(38400)	2
Parity	1083	0 (none), 1 (odd), 2 (even)	0
Stop bits	1085	0 (1 bits), 1 (2 bits)	0

Table 18: Modbus memory map: programming variables (Table 4)

Transformation ratios			
Configuration variable	Address	Valid data margin	Default value
Current primary	1090	1 - 10000	5
Current secondary	1091	0 (1 A), 1 (5 A)	1
Voltage primary	1092-1093	1 -99999	1
Voltage secondary	1094-1095	1 -99999	1

Table 19: Modbus memory map: programming variables (Table 5)

Connection type			
Configuration variable	Address	Valid data margin	Default value
Connection type	1100	0 (3U.3C), 1 (3U.1C), 2 (2U.1C)	0
Phase ⁽¹⁰⁾	1101	1 to 6 (Table 41)	1
Current 1 ⁽¹⁰⁾⁽¹¹⁾	1102	1 (Phase 1 direct), 2 (Phase 2 direct), 3 (Phase 3 direct), 4 (Phase 1 re- verse), 5 (Phase 2 reverse), 6 (Phase 3 reverse),	1
Current 2 ⁽¹⁾⁽¹¹⁾	1103		2
Current 3 ⁽¹⁾⁽¹¹⁾	1104		3

⁽¹⁰⁾ Only used when the connection type is other than 3U.3C.

⁽¹¹⁾ Indicates the relationship between the assigned voltage and the current direction.

Example: If you see Current 1 = 1, Current 2 = 5 and Current 3 = 3, this means that: Current 1 is assigned to voltage 1 in the direct direction, current 2 is assigned to voltage 2 in the reverse direction and current 3 is assigned to voltage 3 in the direct direction.

Table 20: Modbus memory map: programming variables (Table 6)

Status of the stages			
Configuration variable	Address	Valid data margin	Default value
C1	1110	0 (Auto), 1 (On), 2 (OFF), 3 (OnNc)	0
C2	1111		0
C3	1112		0
C4	1113		0
C5	1114		0
C6	1115		0
C7	1116		0
C8	1117		0
C9	1118		0
C10	1119		0
C11	111A		0
C12	111B		0

Table 21: Modbus memory map: programming variables (Table 7)

Voltage level			
Configuration variable	Address	Valid data margin	Default value
Voltage level	1121	0 (Low voltage) 1 (Medium/High voltage)	0

Table 22: Modbus memory map: programming variables (Table 8)

Display			
Configuration variable	Address	Valid data margin	Default value
Lighting (Backlight)	1125	0 (Comes on when pressing a key) 1 (ON), 2 (OFF)	0
Lighting level	1126	0 -10 (Value % / 10)	7
Language	1127	0 (Spanish), 1 (English), 2 (French)	0
Advanced setup	1128	0 (OFF), 1 (ON)	0
Analogue bar	1129	0 (No), 1 (Current), 2 (ITHD) 3 (Connected power)	0

Table 23: Modbus memory map: programming variables (Table 9)

Target cos φ			
Configuration variable	Address	Valid data margin	Default value
Target cos φ 1	1130	0 - 100 (Value x 100)	100
Target cos φ 2	1131		100
Target cos φ 3	1132		100
Target cos φ 4	1133		100
Target cos φ 1 type	1134	0 (Capacitive) 1 (Inductive)	1
Target cos φ 2 type	1135		1
Target cos φ 3 type	1136		1
Target cos φ 4 type	1137		1

Table 24: Modbus memory map: programming variables (Table 10)

C/K factor			
Configuration variable	Address	Valid data margin	Default value
C/K factor	1138	0 - 100 (Value x 100)	100

Table 25: Modbus memory map: programming variables (Table 11)

Program			
Configuration variable	Address	Valid data margin	Default value
Program	1139	1111-1999	1111
Operation type	113A	0(FCP), 1(Total), 2(Sim)	0

Table 26: Modbus memory map: programming variables (Table 12)

No. of stages			
Configuration variable	Address	Valid data margin	Default value
No. of stages	113B	0-6 (Computer SMART III FAST 6) 0-12 (Computer SMART III FAST 12)	6 12

Table 27: Modbus memory map: programming variables (Table 13)

Connection and reconnection time			
Configuration variable	Address	Valid data margin	Default value
Connection time	113C	0-999 network cycles	10
Reconnection time	113D	0-999 network cycles	50

Table 28: Modbus memory map: programming variables (Table 14)

Alarm: Voltage THD			
Configuration variable	Address	Valid data margin	Default value
Low Value	1140	0 - 100 %	5
Hi Value	1141	0 - 100 %	10

Table 29: Modbus memory map: programming variables (Table 15)

Alarm: Current x I THD			
Configuration variable	Address	Valid data margin	Default value
Low Value	1142	0 ... 9999 A	4
Hi Value	1143	0 ... 9999 A	5

Table 30: Modbus memory map: programming variables (Table 16)

Alarm: Temperature			
Configuration variable	Address	Valid data margin	Default value
Low Value	1144	0 - 80 °C	55
Hi Value	1145	0 - 80 °C	70

Table 31: Modbus memory map: programming variables (Table 17)

Alarm: Leakage Current			
Configuration variable	Address	Valid data margin	Default value
Search for the responsible stage	1146	0 (OFF), 1 (ON)	0
Value	1147	10 - 1000 mA	300
Stages enabled	1148	0 (No), 1 (Yes)	0

Table 32: Modbus memory map: programming variables (Table 18)

Alarm: Cos ϕ			
Configuration variable	Address	Valid data margin	Default value
Value of Cos ϕ	1149	80 -100 (Value x 100)	95
Current value	114A	0 - 9999 A	20
Type of Cos ϕ	114B	0 (Capacitive), 1 (Inductive)	1

Table 33: Modbus memory map: programming variables (Table 19)

Alarm: Fan			
Configuration variable	Address	Valid data margin	Default value
Value	114C	0 - 80 °C	35
Enabled	114D	0 (OFF), 1 (ON)	0

Table 34: Modbus memory map: programming variables (Table 20)

Alarm: Voltage			
Configuration variable	Address	Valid data margin	Default value
Overvoltage value	114E-114F	0-99999	440
No Voltage Value	1150-1151	0-99999	360

Table 35: Modbus memory map: programming variables (Table 21)

No. of operations			
Configuration variable	Address	Valid data margin	Default value
No. of operations	1152-1153	1-99999	5000

Table 36: Modbus memory map: programming variables (Table 22)

Enabling alarms			
Configuration variable	Address	Valid data margin	Default value
Enable Alarm E01	1155	0 (OFF), 1 (ON)	1
Enable Alarm E02	1156		1
Enable Alarm E03	1157		1
Enable Alarm E04	1158		1
Enable Alarm E05	1159		0
Enable Alarm E06	115A		0
Enable Alarm E07	115B		0
Enable Alarm E08	115C		0
Enable Alarm E09	115D		0
Enable Alarm E10	115E		0
Enable Alarm E11	115F		0
Enable Alarm E12	1160		0
Enable Alarm E13	1161		0
Enable Alarm E14	1162		0
Enable Alarm E15	1163		0
Enable Alarm E16	1164		0
Enable Alarm E17	1165		0

Table 36 (Continuation): Modbus memory map: programming variables (Table 22)

Enabling alarms			
Configuration variable	Address	Valid data margin	Default value
Output associated with Alarm E01	1170	0 (No), 1 (Alarm relay), 2 (Digital output 1) 2 (Digital output 2)	0
Output associated with Alarm E02	1171		0
Output associated with Alarm E03	1172		0
Output associated with Alarm E04	1173		0
Output associated with Alarm E05	1174		0
Output associated with Alarm E06	1175		0
Output associated with Alarm E07	1176		0
Output associated with Alarm E08	1177		0
Output associated with Alarm E09	1179		0
Output associated with Alarm E10	1179		0
Output associated with Alarm E11	117A		0
Output associated with Alarm E12	117B		0
Output associated with Alarm E13	117C		0
Output associated with Alarm E14	117D		0
Output associated with Alarm E15	117E		0
Output associated with Alarm E16	117F		0
Output associated with Alarm E17	1180		0

C.- Deleting parameters

Parameters can be deleted using **Function 05**: writing a relay.

Table 37: Modbus memory map: deleting parameters

Deleting parameters		
Action	Address	Value to be sent
Deleting maximum values	200	FF
Deleting minimum values	210	FF
Deleting maximum and minimum values	220	FF
Deleting energies	230	FF
Deleting the stage search and stage enabling values of the leakage current alarm	240	FF
Deleting the no. of operations of all the relays	250	FF
Resetting alarms E14 and E15	260	FF
Restoring the default configuration values	300	FF

4.9.4. EXAMPLE OF A MODBUS QUERY

Query: Instantaneous value of the L1 phase voltage

Address	Function	Initial log	No. of logs	CRC
0A	04	0000	0002	70B0

Address: 0A, Peripheral number: 10 in decimal.

Function: 04, Read function.

Initial Log: 0000, log from which to start reading.

No. of logs: 0002, number of logs to be read.

CRC: 70B0, CRC character.

Response:

Address	Function	No. of Bytes	Log no. 1	Log No. 2	CRC
0 A	04	04	0000	084D	8621

Address: 0A, Responding peripheral number: 10 in decimal.

Function: 04, Read function.

No. of bytes: 04, No. of bytes received.

Log: 000084D, value of the L1 phase voltage: VL1 x 10 : 212.5V

CRC: 8621, CRC Character.

4.10.- CPC-NET COMMUNICATIONS

Computer SMART III FAST series regulators are designed to control static capacitor banks where they can operate through optoMOS relay outputs or through communications. If communications are used, they must be connected to **CPC3i-xRS** zero switching control boards.

The **Computer SMART III FAST** connection with the board will be made through the CPC-NET channel, in accordance with the connection table, **Table 38**. Also consult the terminal diagrams in **Figure 2** and **Figure 18**.

Table 38: Table showing the CPC3i to Computer SMART III FAST connection.

CPC3i-xRS		Computer SMART III FAST		Function
Terminal	Name	Terminal	Name	
A	SH	44	S	Communication cable screen
B	RS+	42	A(+)	Transmitter / Receiver +
C	RS-	43	B (-)	Transmitter / Receiver -

Each CPC3i board of a static capacitor bank must be configured with a different address (1 to 16) for each step, using a rotating ADJ switch with the CPC3i board. (**Figure 18**)

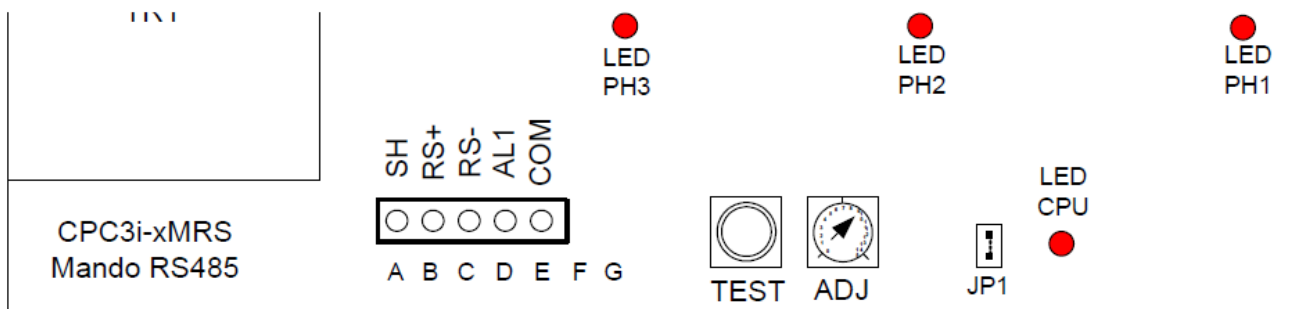

Figure 18:Terminals of the CPC3i-xRS board.

4.10.1. MODBUS CONTROL FRAME

The **Computer SMART III FAST** controls the CPC3i boards using the **MODBUS** protocol. In particular, it sends a frame every 200 ms, using **Function 15**: N bits write. The message is a "broadcast" message, i.e., it will be read by all boards, in any address.

The format of the frame is as follows:

Address	Function	Direction of 1st bit	No. of bits	No. of bytes	Bits value	CRC
00	0F	0064	0040	08	DD0 to DD7	XXXX

Address: 00, Broadcast, all the CPC3i boards receive all the frames.

Function: 0F, Write function.

Direction of 1st bit: 0064, the direction of the 1st bit in the CPC3i board is 0x0064.

No. of bits: 0040, the frame has 64 bits.

No. of bytes: 08, grouped into 8 bytes.

Bits value: The meaning of the 8 bytes is detailed in **Table 39**.

CRC: XXXX, CRC character.

Table 39: Meaning of the 8 bytes, DD0 - DD7.

Byte	Bit 7	Bit 6	Bit 5	Bit 4	Bit 3	Bit 2	Bit 1	Bit 0
DD0	-	thy3_np2	thy2_np2	thy1_np2	-	thy3_np1	thy2_np1	thy1_np1
DD1	-	thy3_np4	thy2_np4	thy1_np4	-	thy3_np3	thy2_np3	thy1_np3
DD2	-	thy3_np6	thy2_np6	thy1_np6	-	thy3_np5	thy2_np5	thy1_np5
DD3	-	thy3_np8	thy2_np8	thy1_np8	-	thy3_np7	thy2_np7	thy1_np7
DD4	-	thy3_np10	thy2_np10	thy1_np10	-	thy3_np9	thy2_np9	thy1_np9
DD5	-	thy3_np12	thy2_np12	thy1_np12	-	thy3_np11	thy2_np11	thy1_np11
DD6	-	thy3_np14	thy2_np14	thy1_np14	-	thy3_np13	thy2_np13	thy1_np13
DD7	-	thy3_np16	thy2_np16	thy1_np16	-	thy3_np15	thy2_np15	thy1_np15

thyn_npx means thyristor n of the block or peripheral x (This number of peripheral, x, is the one programmed in the rotating selector for each board).

Note: The frame asks for the transmission of data to thyristors in up to 16 different steps, phase by phase. The **Computer Smart III FAST** regulator has a maximum of 12 outputs, so it does not use the last 4 steps of the frame.

5.- CONFIGURATION





The various configuration parameters of the unit can be consulted and edited in the unit setup menu.

The unit always keeps the capacitors disconnected (except in the Plug&Play function).

This status is identified by the **SETUP** symbol in the unit status area of the display (**Figure 12**).

To access the setup menu, press and hold the  key (> 3 s).



The Password screen appears on the display. The password to be entered is a combination of keys:    . It is unique and cannot be configured.

If it is not entered correctly, the unit returns to the previous measurement screen.

If it is entered correctly and capacitors are connected, the disconnection screen appears.



Disconnection screen: used for the unit to automatically disconnect all the stages before entering into configuration.

While in this screen, the unit does not respond to the keys.

The unit automatically exits this screen, and this can take a certain amount of time.

5.1.- PLUG&PLAY





The Plug&Play function assists the user during the configuration of the unit, since it automatically configures the basic parameters that are required for the unit to perform its regulation functions correctly.

To start the Plug&Play process, press the



The process enters editing mode. It is identified by the **EDIT** symbol and the blinking of the digits of the display.

Press the  key to switch from *OFF* to *Start*

Press the  key to start the Plug&Play function. Once started, the unit undertakes a process of connecting and disconnecting capacitors, measurement and calculation in order to obtain the following parameters of the capacitor bank:

- ✓ Connection type,
- ✓ Phase,
- ✓ Number of steps.
- ✓ Program
- ✓ C/K factor,

These parameters can also be configured manually from their respective screens.



When the Plug&Play process of the unit is active, this screen is displayed with the **RUN** symbol blinking (it may take several minutes).

The capacitors are connected and disconnected during the process and this will be displayed on the screen.

Once the Plug&Play function of the unit ends, if no errors occurred during the process, the results are shown by the display on two screens, as follows:

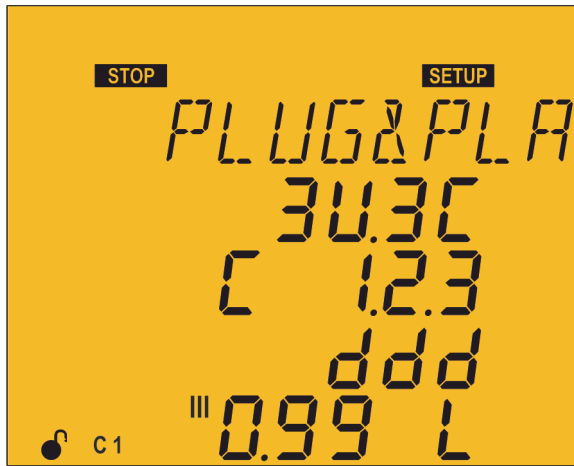
**Connection type:**

3U.3C: 3 voltages and 3 currents.

3U.1C: 3 voltages and 1 current.

2U.1U: 2 voltages and 1 current.

Phase**Cos φ III**

L: Inductive / C: capacitive

+: consumed / -: generated

Press the  key to switch to the next screen of results.

Press the  key to exit the results screen.

**No. steps detected****Program****C/K factor****Cos φ III**

L: Inductive / C: capacitive

+: consumed / -: generated

Press the  key to switch to the previous screen of results.

Press the  key to exit the results screen.

If any errors occur during the execution of the Plug&Play function, the process will be aborted and the errors will be displayed on the screen. When a parameter has been calculated correctly before the error is detected, it will be displayed on the previously assigned line. The errors that can occur in the Plug&Play function are shown in **Table 40**.

Table 40: Code of Plug&Play errors.

Code	Description
P00	There are three possible causes that can prevent the Plug&Play process from starting: - Some stages are cancelled by the leakage current alarm. - Some stages are forced in the configuration " 5.12.- STATUS OF THE STAGES ".
P01	Error when searching for the Connection Type. See connection diagrams.
P02	Phase not found. Cosine out of range (between 0.62 and 0.99 inductive).
P03	Unstable measurement. Load changes during the process.

Table 40 (Continuation): Code of Plug&Play errors.

Code	Description
P04	Error in the measurement of the largest capacitor.
P05	No capacitors found.
P06	Incorrect measurement of the number of capacitors.
P07	Incorrect measurement of the ratio of the first capacitor.
P08	Possible error in the program calculated.
P09	C/K out of range.

In the case of the P00 error, i.e., when capacitors have been deactivated by a leakage current alarm or forced in the On/Off/Auto Configuration, the P&P function will not be started until the problem is resolved.

The Plug&Play function is designed to assist with the installation of the reactive energy compensation system, with the initial configuration of the regulator or when there are changes in the system (new regulator, new cabling, new stage, etc.). For this reason, it is necessary prior to the Plug&Play function to solve the possible problems with faulty capacitors by means of maintenance or replacement, as well as to configure all the stages in Auto mode, as they come by default.

	<p>Conditions for the correct operation of the Plug&Play function:</p> <ul style="list-style-type: none"> ✓ The system should be maintained with an inductive cosine of 0.62 to 0.99 throughout the process. ✓ The power in the system should be stable. Any major load changes (>10 % in less than 20 seconds) would result in an incorrect calculation of the capacitor power ratings. ✓ There must be enough current in the system, above 100 mA AC at the regulator intake. ✓ If the load is unbalanced, the correct operation of the Plug&Play function will depend on the phase to which the current transformer is connected.
---	--

	<p>Once the Plug&Play function is finished, the primary of the current transformer needs to be configured in order for the unit to measure the current and the powers correctly.</p>
---	--

Press the  key to move on to the next configuration point.

If no keys are pressed for 5 minutes, the unit switches to the simulation screen, “5.27.- SIMULATION SCREEN”.

5.2.- CURRENT TRANSFORMATION RATIO

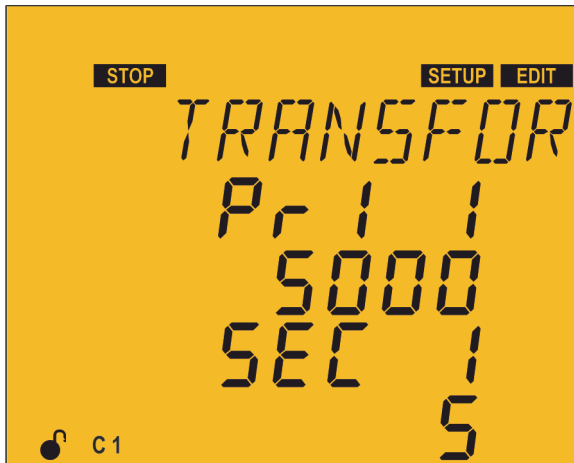



The primary and secondary value of the current transformer is configured in this point.

Press the  key to enter editing mode. It is identified by the **EDIT** symbol and the blinking of the digits to be modified.

The  key increases the digit value or shows the next option.

The  key decreases the digit value or shows the next option.

The  key skips to the previous digit.

The  key skips to the next digit.

Press  to validate the data; the **EDIT** symbol disappears from the display.

Current primary:

Maximum value: 9999.

Minimum value: 1.

Current secondary:

Possible values: 1 or 5.

Maximum possible current ratio: 2500.

NB: The current ratio is the ratio between the current primary and secondary.

Maximum value of the current ratio x the voltage ratio: 200000.

If the value entered is lower than the minimum value or higher than the maximum value, the backlight of the display flashes and the value entered is replaced with the minimum or maximum value, or with the last value validated.

Press the  key to access the next programming step

If no keys are pressed for 5 minutes, the unit switches to the simulation screen, “**5.27.- SIMULATION SCREEN**”.

5.3.- TARGET COS φ

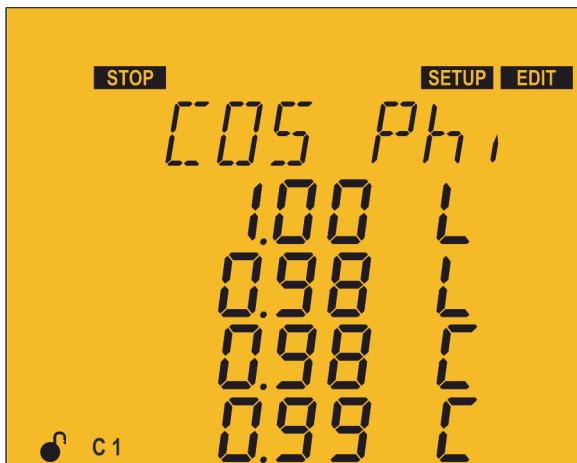

The $\cos \varphi$ makes it possible to define the power factor required for the installation. The **Computer SMART III FAST** will add the number of capacitors needed to adjust the value as close as possible to the objective value. Since the regulation is by stages, it does not perform any operations until the uncompensated demand is at least 70 % of the power of the smallest stage or the compensation surplus is 70 % of the power of the smallest stage.

Four target cosines can be configured, depending on the status of the digital inputs (See “4.7.- INPUTS”) the unit allows one of the 4 programmed cosines.

For every cosine, you must program the value and state whether it is inductive L or capacitive C.

Press the  key to enter editing mode. It is identified by the **EDIT** symbol and the blinking of the digits to be modified.

The  key increases the digit value or shows the next option.

The  key decreases the digit value or shows the next option.

The  key skips to the previous digit.

The  key skips to the next digit.

Press  to validate the data; the **EDIT** symbol disappears from the display.

Maximum value: 1.00.

Minimum value: 0.80.

If the value entered is lower than the minimum value or higher than the maximum value, the backlight of the display flashes and the value entered is replaced with the minimum or maximum value, or with the last value validated.

Press key  to access the next programming step.

If no keys are pressed for 5 minutes, the unit switches to the simulation screen, “5.27.- SIMULATION SCREEN”.

5.4.- CONNECTION AND RECONNECTION TIME



In this point the action times of the device are configured in seconds:

t_{on} is the minimum time between the connection and disconnection of a single stage (counted in number of network cycles).

t_{rEc} is the minimum time between the disconnection and connection of a single stage (counted in number of network cycles).

Press the  key to enter editing mode. It is identified by the **EDIT** symbol and the blinking of the digits to be modified.

The  key increases the digit value.

The  key decreases the digit value.

The  key skips to the previous digit.

The  key skips to the next digit.

Press  to validate the data; the **EDIT** symbol disappears from the display.

t_{on} :

Maximum value: 999.

Minimum value: 2.

t_{rEc} :

Maximum value: 999.

Minimum value: 0.

If the value entered is lower than the minimum value or higher than the maximum value, the backlight of the display flashes and the value entered is replaced with the minimum or maximum value, or with the last value validated.

Press the  key to access the next programming step

If no keys are pressed for 5 minutes, the unit switches to the simulation screen, “5.27.- SIMULATION SCREEN”.

5.5.- CONNECTION TYPE



In this point the connection type of the installation is selected, where:

3U3C: 3 voltages + neutral and 3 currents.

3U 1C: 3 voltages + neutral and 1 current.

2U 1C: 2 voltages and 1 current.

Press the  key to enter editing mode. It is identified by the **EDIT** symbol and the blinking of the digits to be modified.

The  key shows the next option.

The  key shows the previous option.

Press  to validate the data; the **EDIT** symbol disappears from the display.

Press the  key to access the next programming step.

If no keys are pressed for 5 minutes, the unit switches to the simulation screen, “5.27.- SIMULATION SCREEN”.

5.6.- PHASE CONNECTION

This parameter is used to adapt the unit to the various options for connecting the power supply and measurement cables and the current transformers to the phases of the three-phase system.

The connection screen changes according to the connection type programmed in the preceding point.

✓ **Connection type 3U 1C or 2U 1C**



If a connection with a single current has been selected (3U 1C or 2U 1C), one of the 6 possible phases indicated in **Table 41** are selected in this screen.

The selection of one or another of the options must be made when inductive reactive power with an inductive $\cos \varphi$ of 0.6 to 1 is being consumed in the installation at the time of adjustment. The various options are tried until the screen shows a $\cos \varphi$ of 0.6 to 1 (the display of the $\cos \varphi$ is only informative, not editable).

Press the  key to enter editing mode. It is identified by the **EDIT** symbol and the blinking of the digits to be modified.

The  key shows the next option.

The  key shows the previous option.

Press  to validate the data; the **EDIT** symbol disappears from the display.

Press the  key to access the next programming step.

If no keys are pressed for 5 minutes, the unit switches to the simulation screen, “5.27.-SIMULATION SCREEN”.

Table 41: Phase connection options.

Phases	V measurement phase	CT connection phase
<i>PH1</i>	L1-L2-L3	L1
<i>PH2</i>	L1-L2-L3	L2
<i>PH3</i>	L1-L2-L3	L3
<i>PH4</i>	L1-L2-L3	L1 (inverted transformer)
<i>PH5</i>	L1-L2-L3	L2 (inverted transformer)
<i>PH6</i>	L1-L2-L3	L3 (inverted transformer)

✓ Connection type 3U3C



If the connection with three currents has been selected (3U3C), each current is associated with its voltage and the direction of the current is indicated in this screen.

d: direct.

i: reverse.

Press the  key to enter editing mode. It is identified by the **EDIT** symbol and the blinking of the digits to be modified.

The  key shows the next option.

The  key shows the previous option.

The  key skips to the previous voltage.

The  key skips to the next voltage.

Press  to validate the data; the **EDIT** symbol disappears from the display.

Press the  key to access the next programming step.

If no keys are pressed for 5 minutes, the unit switches to the simulation screen, “**5.27.- SIMULATION SCREEN**”.

5.7.- NO. OF STAGES



In this point the number of stages is selected, in other words the number of relay outputs that the unit will have.

Depending on whether the model is **Computer SMART III FAST 6** or **SMART III FAST 12**, it can be configured with up to 6 or up to 12 outputs.

Press the  key to enter editing mode. It is identified by the **EDIT** symbol and the blinking of the digits to be modified.

The  key shows the next option.

The  key shows the previous option.

Press  to validate the data; the **EDIT** symbol disappears from the display.

Press the  key to access the next programming step.

If no keys are pressed for 5 minutes, the unit switches to the simulation screen, “**5.27.- SIMULATION SCREEN**”.

5.8.- PROGRAM



The unit is made up of stages with different powers. The base power (value 1) will be that of the stage with the lowest power. The powers of all the other stages will depend on the power of the first stage.

Example:

Program 1.1.1.1, all the stages have the same power as the first one.

Program 1.2.4.4, the second stage has twice the power and the next ones have four times the power of the first one. (See “4.1.4 Regulation program”)

When configuring the program, remember that the subsequent stage cannot be lower than the prior stage, and that the first stage is always 1.

Also program the system that controls the connection sequence of the different stages, where:

FCP, operation following the **FCP** (“4.1.3 FCP System (FAST Computerized Program)”)

GLOBAL, total operation where all the steps are connected or disconnected at the same time, without following a sequence; This operation is faster than the **FCP**.

Sim, no operation, the unit stays in simulation mode⁽¹²⁾.

⁽¹²⁾ In **Sim** mode, the measurement screens simulate the outputs that the unit would connect or disconnect, but it doesn't actually do so. To avoid confusion, on the measurement screens the name of the screen is switched with the literal *ModE Sim*.

Press the  key to enter editing mode. It is identified by the **EDIT** symbol and the blinking of the digits to be modified.

The  key increases the digit value.

The  key decreases the digit value.

The  key skips to the previous digit.

The  key skips to the next digit.

Press  to validate the data; the **EDIT** symbol disappears from the display.

Minimum value: 1.1.1.1

Maximum value: 1.9.9.9

Press the  key to access the next programming step.

If no keys are pressed for 5 minutes, the unit switches to the simulation screen, “5.27.- SIMULATION SCREEN”.

5.9.- C/K FACTOR

The C/K factor is adjusted according to the reactive current provided by the smallest stage, measured in the secondary of the current transformer (CT). The adjustment value of this factor therefore depends on the power of the smallest stage, the ratio of the CTs and the network voltage.

Table 42 and Table 43 provide the values to which the C/K should be adjusted for a 400 V AC network between phases, various transformer ratios and powers of the smallest stage.

Table 42: C/K factor (table 1).

CT Ratio (Ip / Is)	Power of the smallest stage at 400 V (in kvar)													
	2.5	5.0	7.5	10.0	12.5	15.0	20.0	25.0	30.0	40.0	50.0	60.0	75.0	80.0
150/5	0.12	0.24	0.36	0.48	0.60	0.72	0.96							
200/5	0.09	0.18	0.27	0.36	0.45	0.54	0.72	0.90						
250/5	0.07	0.14	0.22	0.29	0.36	0.43	0.58	0.72	0.87					
300/5	0.06	0.12	0.18	0.24	0.30	0.36	0.48	0.60	0.72	0.96				
400/5	0.05	0.09	0.14	0.18	0.23	0.24	0.36	0.48	0.58	0.72	0.87			
500/5		0.07	0.11	0.14	0.18	0.22	0.29	0.36	0.45	0.54	0.72	0.87		
600/5		0.06	0.09	0.12	0.15	0.18	0.24	0.30	0.36	0.48	0.60	0.72	0.90	0.96
800/5			0.07	0.09	0.11	0.14	0.18	0.23	0.27	0.36	0.45	0.54	0.68	0.72
1000/5			0.05	0.07	0.09	0.11	0.14	0.18	0.22	0.29	0.36	0.43	0.54	0.57
1500/5				0.05	0.06	0.07	0.10	0.12	0.14	0.19	0.24	0.29	0.36	0.38
2000/5						0.05	0.07	0.09	0.11	0.14	0.18	0.22	0.27	0.28
2500/5							0.06	0.07	0.09	0.12	0.14	0.17	0.22	0.23
3000/5							0.05	0.06	0.07	0.10	0.12	0.14	0.18	0.19
4000/5									0.05	0.07	0.09	0.11	0.14	0.14

If the capacitor power reference of 440 V is used for a 400 V network voltage, the table is Table 43.

Table 43: C/K factor (table 2).

CT Ratio (Ip / Is)	Power of the smallest stage at 440 V (in kvar)													
	2.5	5.0	7.5	10.0	12.5	15.0	20.0	25.0	30.0	40.0	50.0	60.0	75.0	80.0
150/5	0.09	0.18	0.27	0.36	0.45	0.54	0.72	0.90						
200/5	0.07	0.14	0.20	0.27	0.34	0.41	0.54	0.68	0.81					
250/5	0.05	0.11	0.16	0.22	0.27	0.33	0.43	0.54	0.65	0.87				
300/5	0.05	0.09	0.14	0.18	0.23	0.27	0.36	0.45	0.54	0.72	0.90			
400/5		0.07	0.10	0.14	0.17	0.20	0.27	0.34	0.41	0.54	0.68	0.81		
500/5		0.05	0.08	0.11	0.14	0.16	0.22	0.27	0.33	0.43	0.54	0.65	0.81	0.87
600/5		0.05	0.07	0.09	0.11	0.14	0.18	0.23	0.27	0.36	0.45	0.54	0.68	0.72
800/5			0.05	0.07	0.08	0.10	0.14	0.17	0.20	0.27	0.34	0.41	0.51	0.54
1000/5			0.04	0.05	0.07	0.08	0.11	0.14	0.16	0.22	0.27	0.33	0.41	0.43
1500/5				0.04	0.05	0.05	0.07	0.09	0.11	0.14	0.18	0.22	0.27	0.29
2000/5						0.04	0.05	0.07	0.08	0.11	0.14	0.16	0.20	0.22
2500/5							0.04	0.05	0.07	0.09	0.11	0.13	0.16	0.17
3000/5							0.04	0.05	0.05	0.07	0.09	0.11	0.14	0.14
4000/5									0.04	0.05	0.07	0.08	0.10	0.11

For other voltages or conditions not included in the table, the value of C/K can be obtained by means of a simple calculation.

✓Calculating the C/K Factor

The equation for calculating the C/K factor is:

$$C/K = \frac{I_c}{K}$$

where **I_c**: is the smallest capacitor current.

K: the current transformer transformation ratio.

To calculate **I_c** it is necessary to know the reactive power of the smallest capacitor **Q** and the network voltage **V**.

$$I_c = \frac{Q}{\sqrt{3} \cdot V}$$

The transformation ratio K is calculated as:

$$K = I_{prim} / I_{sec}$$

where **I_{prim}** : is the nominal current of the transformer primary.

I_{sec}: is the current of the transformer secondary.

Example: In a 400 V unit the smallest capacitor is of 60 kvar with a current transformer having a ratio of 500/5, and the calculation would be made as follows:

Current of the smallest capacitor **I_c**: $I_c = \frac{60000}{\sqrt{3} \cdot 400}$

K Factor $K = 500/5 = 100$

The C/K value is: **0.866**.

If the power of 60 kvar is referenced at 440 V, it should be multiplied by $V_{grid}^2 / 440^2$ in which case the C/K value of the previous example would be **0.72**.





If the C/K is configured lower than the actual value, connections and disconnections would occur continuously with few load variations (the system performs more operations than necessary).



If the C/K is configured higher, the regulator requires a higher demand for reactive power in order to switch and perform fewer operations.



Press the  key to enter editing mode. It is identified by the **EDIT** symbol and the blinking of the digits to be modified.

The  key increases the digit value.

The  key decreases the digit value.

The  key skips to the previous digit.

The  key skips to the next digit.

Press  to validate the data; the **EDIT** symbol disappears from the display.

Minimum value: 0.02

Maximum value: 1.0

If the value entered is lower than the minimum value or higher than the maximum value, the backlight of the display flashes and the value entered is replaced with the minimum or maximum value, or with the last value validated.

Press the  key to access the next programming step.

If no keys are pressed for 5 minutes, the unit switches to the simulation screen, **"5.27.- SIMULATION SCREEN"**.

5.10.- ADVANCED SETUP



In this point it is possible to decide whether to access the advanced setup menu.

If the *YES* option is selected, the next programming step will be the voltage transformation ratio ("**5.11.- VOLTAGE TRANSFORMATION RATIO**")

When the *NO* option is selected, the display returns to the Plug&Play configuration screen ("**5.1.- PLUG&PLAY**")

Press the  key to enter editing mode. It is identified by the **EDIT** symbol and the blinking of the digits to be modified.

The  key shows the next option.

The  key shows the previous option.

Press  to validate the data; the **EDIT** symbol disappears from the display.

Press the  key to access the next programming step.

If no keys are pressed for 5 minutes, the unit switches to the simulation screen, “5.27.- SIMULATION SCREEN”.

5.11.- VOLTAGE TRANSFORMATION RATIO

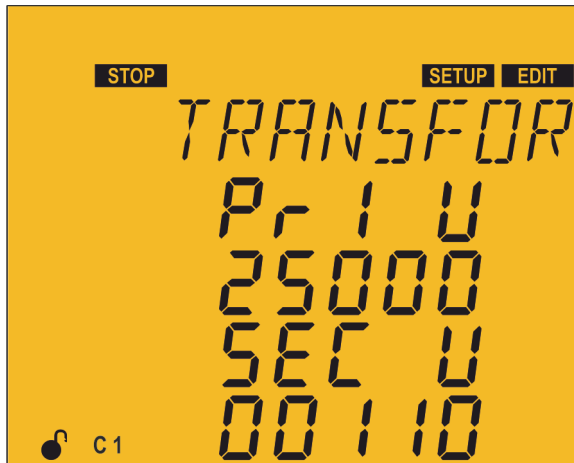

In this point the primary and secondary value of the voltage transformer can be configured.

Press the  key to enter editing mode. It is identified by the **EDIT** symbol and the blinking of the digits to be modified.

The  key increases the digit value.

The  key decreases the digit value.

The  key skips to the previous digit.

The  key skips to the next digit.

Press  to validate the data; the **EDIT** symbol disappears from the display.

Voltage primary:

Maximum value: 99999.

Minimum value: 1.

Voltage secondary:

Maximum value: 99999.

Minimum value: 1.

Maximum possible voltage ratio: 1000.

NB: The voltage ratio is the ratio between the primary and secondary voltage.

Maximum value of the current ratio x the voltage ratio: 200000.

If the value entered is lower than the minimum value or higher than the maximum value, the backlight of the display flashes and the value entered is replaced with the minimum or maximum value, or with the last value validated.

Press the  key to access the next programming step.

If no keys are pressed for 5 minutes, the unit switches to the simulation screen, **“5.27.- SIMULATION SCREEN”**.

5.12.- STATUS OF THE STAGES



This parameter is repeated for each of the 6 or 12 possible stages, offering the opportunity to force their status without paying attention to the operation performed by the actual unit.

In order to identify which of the 12 stages is being configured, the screen shows C 1, C2, etc.

The configuration options for each stage are as follows:

- ✓ **AUTO**: The status of the stage depends on the operation performed by the unit.
- ✓ **ON**: Stage forced to ON, always connected.
- ✓ **OFF**: Stage forced to OFF, always disconnected.
- ✓ **ON nC**: Stage forced to ON, always connected but the system does not take into account its connected power.

By default, all the stages are configured as **AUTO**.

On the measurement screens, the forced states of the stages are shown by activating the bottom line of the capacitor status bar. (**“4.4.1. STATUS OF THE CAPACITORS”**)

Press the  key to enter editing mode. It is identified by the **EDIT** symbol and the blinking of the digits to be modified.

The  key shows the next option.

The  key shows the previous option.

The  key skips to the previous stage.

The  key skips to the next stage.

Press  to validate the data; the **EDIT** symbol disappears from the display.

Press the  key to access the next programming step.

If no keys are pressed for 5 minutes, the unit switches to the simulation screen, **“5.27.- SIMULATION SCREEN”**.

5.13.- DISPLAY



In this point the lighting status of the screen and its language can be configured.

Press the  key to enter editing mode. It is identified by the **EDIT** symbol and the blinking of the digits to be modified

The following display configuration options are available:

- ✓ **On**: the display light is always on.
- ✓ **OFF**: the light is always off.
- ✓ **AUTO**: the light comes on when a key is pressed and switches off when no keys have been pressed for 5 minutes.

The light level is also configured between 0 % and 100 % when the display is on.

The display language options are as follows:

- ✓ **ESP**: Spanish.
- ✓ **ENG**: English.
- ✓ **FRF**: French.

The  key increases the digit value or shows the next option.

The  key decreases the digit value or shows the next option.

The  key skips to the previous parameter.

The  key skips to the next parameter.

Press  to validate the data; the **EDIT** symbol disappears from the display.

Press the  key to access the next programming step.

If no keys are pressed for 5 minutes, the unit switches to the simulation screen, “**5.27.- SIMULATION SCREEN**”.

5.14.- ANALOGUE BAR



At this point the parameter to be displayed in the analogue bar is configured ("**4.4.3. ANALOGUE BAR**")

Press the  key to enter editing mode. It is identified by the **EDIT** symbol and the blinking of the digits to be modified.

The following display options are available for the analogue bar:

- ✓ **POtC**: the percentage of power connected to the capacitor bank relative to the total power.
- ✓ **tHdI**: the Current THD of each phase.
- ✓ **I**: the current % of each one of the phases.
- ✓ **n0**: no parameters are displayed.

The  key shows the next option.

The  key shows the previous option.

Press  to validate the data; the **EDIT** symbol disappears from the display.

Press the  key to access the next programming step.

If no keys are pressed for 5 minutes, the unit switches to the simulation screen, "**5.27.- SIMULATION SCREEN**".

5.15.- FAN

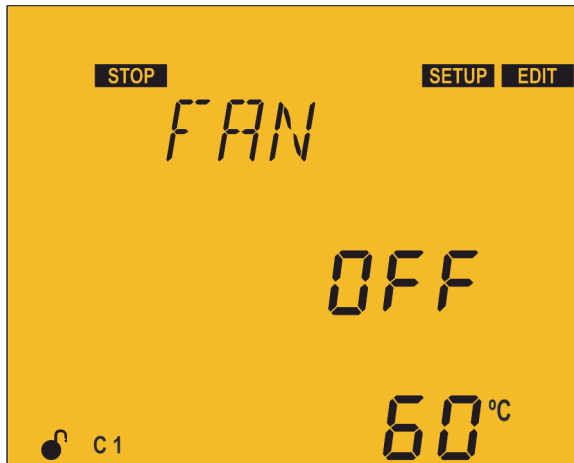

In this point the activation of the relay output associated with the fan can be configured. It is possible to configure whether it is enabled *On* or not *OFF*, as well as the temperature above which it is to be activated or deactivated. The unit has a hysteresis value of 5°C when disconnecting the fan, in order to avoid continuous connections and disconnections.

Press the  key to enter editing mode. It is identified by the **EDIT** symbol and the blinking of the digits to be modified.

The  key increases the digit value or shows the next option.

The  key decreases the digit value or shows the next option.

The  key skips to the previous parameter.

The  key skips to the next parameter.

Press  to validate the data; the **EDIT** symbol disappears from the display.

Maximum value: 80°C.

Minimum value: 0°C.

If the value entered is lower than the minimum value or higher than the maximum value, the backlight of the display flashes and the value entered is replaced with the minimum or maximum value, or with the last value validated.

Press the  key to access the next programming step.

If no keys are pressed for 5 minutes, the unit switches to the simulation screen, “5.27.- SIMULATION SCREEN”.

5.16.- RS-485 COMMUNICATIONS



In this point the RS-485 communication parameters can be configured.

Press the  key to enter editing mode. It is identified by the **EDIT** symbol and the blinking of the digits to be modified.

The parameters to be configured are:

The **peripheral number** assigned, from 1 to 254.

The **transmission speed**, BaudRate: 9600 or 19200.

The **parity**:

- ✓ none: no parity.
- ✓ Even: even parity.
- ✓ Odd: odd parity

The **number of stop bits**: 1 or 2

The  key increases the digit value or shows the next option.

The  key decreases the digit value or shows the next option.

The  key skips to the previous digit or the previous parameter.

The  key skips to the next digit or the next parameter.

Press  to validate the data; the **EDIT** symbol disappears from the display.

If the value entered is lower than the minimum value or higher than the maximum value, the backlight of the display flashes and the value entered is replaced with the minimum or maximum value, or with the last value validated.

Press the  key to access the next programming step.

If no keys are pressed for 5 minutes, the unit switches to the simulation screen, "**5.27.- SIMULATION SCREEN**".

5.17.- CPC-NET COMMUNICATIONS



In this point the CPC-NET communication parameters can be configured.

Press the  key to enter editing mode. It is identified by the **EDIT** symbol and the blinking of the digits to be modified.

The parameters to be configured are:

The **transmission speed**, BaudRate: 9600, 19200 or 38400.

The **parity**:

- ✓ none: no parity.
- ✓ Even: even parity.
- ✓ Odd: odd parity

The **number of stop bits**: 1 or 2

The  key increases the digit value or shows the next option.

The  key decreases the digit value or shows the next option.

The  key skips to the previous digit or the previous parameter.

The  key skips to the next digit or the next parameter.

Press  to validate the data; the **EDIT** symbol disappears from the display.

If the value entered is lower than the minimum value or higher than the maximum value, the backlight of the display flashes and the value entered is replaced with the minimum or maximum value, or with the last value validated.

Press the  key to access the next programming step.

If no keys are pressed for 5 minutes, the unit switches to the simulation screen, **"5.27.- SIMULATION SCREEN"**.

5.18.- CLEAR



In this point it is possible to configure whether or not to delete (YES or NO) the maximum and minimum values, the energies and the number of connections of the stages.

Press the  key to enter editing mode. It is identified by the **EDIT** symbol and the blinking of the digits to be modified.

The following parameters can be deleted:

- ✓ n: maximum and minimum values.
- ✓ E: energies.
- ✓ C: number of connections of the stages.

The  key shows the next option.

The  key shows the previous option.

The  key skips to the previous parameter.

The  key skips to the next parameter.

Press  to validate the data; the **EDIT** symbol disappears from the display.

Press the  key to access the next programming step.

If no keys are pressed for 5 minutes, the unit switches to the simulation screen, “**5.27.- SIMULATION SCREEN**”.

5.19.- ENABLING ALARMS



This screen is repeated for every type of Error or Alarm (from *E01* to *E17*); see **Table 9**. In it the enabling or disabling of each error or alarm can be configured, as can whether or not to associate it with the activation of a relay or a digital output.

The  key skips to the previous error.

The  key skips to the next error.

Press the  key to enter editing mode. It is identified by the **EDIT** symbol and the blinking of the digits to be modified.

The parameters to be configured are:

Enabling *On* or disabling *OFF* the error or alarm.

Association with a relay or digital output alarm:

- ✓ *rELAY*: the activation of the alarm is associated with the alarm relay.
- ✓ *d1*: the activation of the alarm is associated with digital output 1.
- ✓ *d2*: the activation of the alarm is associated with digital output 2.
- ✓ *n0*: not associated with any relay or digital output.

The  key shows the next option.

The  key shows the previous option.

The  key skips to the previous parameter.

The  key skips to the next parameter.

Press  to validate the data; the **EDIT** symbol disappears from the display.

Press the  key to access the next programming step.

If no keys are pressed for 5 minutes, the unit switches to the simulation screen, “**5.27.- SIMULATION SCREEN**”.

5.20.- VOLTAGE ALARMS



In this point the phase-phase voltage thresholds above which the overvoltage alarm ($E05$) and the no voltage alarm ($E06$) should be triggered can be configured.

The alarm must be enabled (“5.19.- ENABLING ALARMS”).

Press the  key to enter editing mode. It is identified by the **EDIT** symbol and the blinking of the digits to be modified.

In order to avoid possible false activations of said alarms, they have a predefined delay of 5 seconds.

The parameters to be configured are:

The **value of the overvoltage alarm**: HI .

The **value of the no voltage alarm**: LO .

When any of the two alarms are triggered, the unit enters the **Disconnection** status and disconnects all the stages. The unit does not return to its normal operating status until the cause for the alarm disappears.

The  key increases the digit value.

The  key decreases the digit value.

The  key skips to the previous digit.

The  key skips to the next digit.

Press  to validate the data; the **EDIT** symbol disappears from the display.

Overvoltage alarm:

Maximum value: 99999 V

Minimum value: 0 V

No voltage alarm:

Maximum value: 99999 V

Minimum value: 0 V

If the value entered is lower than the minimum value or higher than the maximum value, the backlight of the display flashes and the value entered is replaced with the minimum or maximum value, or with the last value validated.

Press the  key to access the next programming step.

If no keys are pressed for 5 minutes, the unit switches to the simulation screen, “5.27.- SIMULATION SCREEN”.

5.21.- COS φ ALARM

In this point the limit for action of the cos φ alarm can be configured.

It is activated every time the value of the cos φ drops below the configured value and the current is higher than programmed.

The alarm must be enabled (“5.19.- ENABLING ALARMS”)

Press the  key to enter editing mode. It is identified by the **EDIT** symbol and the blinking of the digits to be modified.

In order to avoid possible false activations of said alarms, they have a predefined delay of 15 seconds.

The parameters to be configured are:

The **current value**.

The **cos φ value** and whether it is inductive **L** or capacitive **C**.

The  key increases the digit value or shows the next option.

The  key decreases the digit value or shows the next option.

The  key skips to the previous digit.

The  key skips to the next digit.

Press  to validate the data; the **EDIT** symbol disappears from the display.

Current:

Maximum value: 9999 A

Minimum value: 0 A

cos φ :

Maximum value: 1.00

Minimum value: 0.80

If the value entered is lower than the minimum value or higher than the maximum value, the backlight of the display flashes and the value entered is replaced with the minimum or maximum value, or with the last value validated.

Press the  key to access the next programming step.

If no keys are pressed for 5 minutes, the unit switches to the simulation screen, “5.27.- SIMULATION SCREEN”.

5.22.- VOLTAGE THD ALARM



In this point the thresholds above which the Voltage THD alarm (*E08*) is activated can be configured. The alarm must be enabled (“5.19.- **ENABLING ALARMS**”)

The programmed values are useful for the 3 phases which the unit measures.

Press the  key to enter editing mode. It is identified by the **EDIT** symbol and the blinking of the digits to be modified.

The parameters to be configured are:

- ✓ The **Lo value** : when the unit exceeds this value for 30 minutes, alarm *E08* is triggered, and if alarm *E11* is enabled, the **SMART III FAST** unit enters **No Connection** status and activates alarm *E11*.
- ✓ The **Hi value**: if the unit exceeds this value for 30 seconds, alarm *E08* is triggered, and if alarm *E12* is enabled, the **SMART III FAST** unit enters **Disconnection** status and activates alarm *E12*.

If the unit falls back under the **Lo** value for 10 minutes, it deactivates the alarms and returns to the normal operating status.

In the **No Connection** status, the unit does not connect the stages, but also does not disconnect them if the operation requires it.

In the **Disconnection** status, it disconnects the stages and does not allow them to connect.

The  key increases the digit value.

The  key decreases the digit value.

The  key skips to the previous digit.

The  key skips to the next digit.

Press  to validate the data; the **EDIT** symbol disappears from the display.

Lo Value and **Hi Value**:

Maximum value: 99 %

Minimum value: 1 %

If the value entered is lower than the minimum value or higher than the maximum value, the backlight of the display flashes and the value entered is replaced with the minimum or maximum value, or with the last value validated.

Press the  key to access the next programming step.

If no keys are pressed for 5 minutes, the unit switches to the simulation screen, “5.27.- SIMULATION SCREEN”.

5.23.- CURRENT x I THD ALARM



In this point the thresholds above which the alarm for the percentage of the value of the current x ITHD (E09) is activated can be configured.

The alarm must be enabled (“5.19.- ENABLING ALARMS”)

The programmed values are useful for the 3 phases which the unit measures.

Press the  key to enter editing mode. It is identified by the **EDIT** symbol and the blinking of the digits to be modified.

The value to be programmed in this alarm corresponds directly to the value of the total harmonic current to be considered as the setpoint. **For example:** If you want to program a $L\alpha$ setpoint value when exceeding a harmonic current of 200 A measured by the regulator, program 00200 directly in this section.

The parameters to be configured are:

- ✓ The $L\alpha$ value: when the unit exceeds this value for 30 minutes, alarm E09 is triggered, and if alarm E11 is enabled, the **SMART III FAST** unit enters **No Connection** status and activates alarm E11.
- ✓ The $H\alpha$ value: if the unit exceeds this value for 30 seconds, alarm E09 is triggered, and if alarm E12 is enabled, the **SMART III FAST** unit enters the **Disconnection** status and activates alarm E12.

If the unit falls back under the $L\alpha$ value for 10 minutes, it deactivates the alarms and returns to the normal operating status.

In the **No Connection** status, the unit does not connect the stages, but also does not disconnect them if the operation requires it.

In the **Disconnection** status, it disconnects all the stages and does not allow them to connect.

The  key increases the digit value.

The  key decreases the digit value.

The  key skips to the previous digit.

The  key skips to the next digit.

Press  to validate the data; the **EDIT** symbol disappears from the display.

Lo Value and **Hi Value**:

Maximum value: 9999.

Minimum value: 1

If the value entered is lower than the minimum value or higher than the maximum value, the backlight of the display flashes and the value entered is replaced with the minimum or maximum value, or with the last value validated.

Press the  key to access the next programming step.

If no keys are pressed for 5 minutes, the unit switches to the simulation screen, **“5.27.- SIMULATION SCREEN”**.

5.24.- TEMPERATURE ALARM



In this point the thresholds above which the temperature alarm (**E 10**) is activated can be configured.

The alarm must be enabled (**“5.19.- ENABLING ALARMS”**)

Press the  key to enter editing mode. It is identified by the **EDIT** symbol and the blinking of the digits to be modified.

The parameters to be configured are:

✓ The **Lo value** : when the unit exceeds this value for 30 minutes, alarm **E 09** is triggered, and if alarm **E 11** is enabled, the **SMART III FAST** unit enters **No Connection** status and activates alarm **E 11**.

✓ The **Hi value**: if the unit exceeds this value for 30 seconds, alarm **E 09** is triggered, and if alarm **E 12** is enabled, the **SMART III FAST** unit enters **Disconnection** status and activates alarm **E 12**.

If the unit falls back under the **Lo** value for 10 minutes, it deactivates the alarms and returns to the normal operating status.

In the **No Connection** status, the unit does not connect the stages, but also does not disconnect them if the operation requires it.

In the **Disconnection** status, it disconnects all the stages and does not allow them to connect.

The  key increases the digit value.

The  key decreases the digit value.

The  key skips to the previous digit.

The  key skips to the next digit.

Press  to validate the data; the **EDIT** symbol disappears from the display.

Lo Value and **Hi Value**:

Maximum value: 80°C.

Minimum value: 0°C

If the value entered is lower than the minimum value or higher than the maximum value, the backlight of the display flashes and the value entered is replaced with the minimum or maximum value, or with the last value validated.

Press the  key to access the next programming step.

If no keys are pressed for 5 minutes, the unit switches to the simulation screen, **“5.27.- SIMULATION SCREEN”**.

5.25.- LEAKAGE CURRENT ALARM



In this point the parameters of the leakage current alarm can be configured.

Four alarms are linked to the leakage current: (E 13, E 14, E 15 and E 16).

The alarms must be enabled ("5.19.- ENABLING ALARMS")

Press the  key to enter editing mode. It is identified by the **EDIT** symbol and the blinking of the digits to be modified.

The parameters to be configured are:

- ✓ The **alarm value**: when the unit exceeds this value, alarm E 13 is triggered.
- ✓ **Search for the responsible stage**: if this parameter is programmed as 0n, the unit performs a process of connecting and disconnecting all the stages in order to find which ones are responsible for the leakage and, once they have been detected, cancels them so that they cannot connect again. The unit triggers alarms E 13 and E 15 and the disabled stages are intermittently displayed on the screen.
If the unit has a *5/n*-type operation configured (see section "5.8.- PROGRAM"), the responsible stage's search process will not be done even if it is enabled to do so.
- ✓ **Enable stages**: in this parameter, the stages that were disabled by this alarm are enabled again (YES option).

The  key increases the digit value and the next option.

The  key decreases the digit value and the previous option.

The  key skips to the previous digit.

The  key skips to the next digit.

Press  to validate the data; the **EDIT** symbol disappears from the display.

Maximum value: 999 mA.

Minimum value: 1 mA.

If the value entered is lower than the minimum value or higher than the maximum value, the backlight of the display flashes and the value entered is replaced with the minimum or maximum value, or with the last value validated.

Press the  key to access the next programming step.

If no keys are pressed for 5 minutes, the unit switches to the simulation screen, "5.27.- SIMULATION SCREEN".

5.26.- NO. OF OPERATIONS ALARM



In this point the number of operations of any of the stages above which the alarm $E 17$ will be triggered can be configured.

The alarms must be enabled (“5.19.- **ENABLING ALARMS**”)

Press the  key to enter editing mode. It is identified by the **EDIT** symbol and the blinking of the digits to be modified.

There are thousands of operations (k), so a value of 100 k will mean 100,000 operations.

The  key increases the digit value.

The  key decreases the digit value.

The  key skips to the previous digit.

The  key skips to the next digit.

Press  to validate the data; the **EDIT** symbol disappears from the display.

Maximum value: 99999 k.

Minimum value: 1 k.

If the value entered is lower than the minimum value or higher than the maximum value, the backlight of the display flashes and the value entered is replaced with the minimum or maximum value, or with the last value validated.

Press the  key to access the next programming step.

If no keys are pressed for 5 minutes, the unit switches to the simulation screen, “5.27.- **SIMULATION SCREEN**”.

5.27.- SIMULATION SCREEN

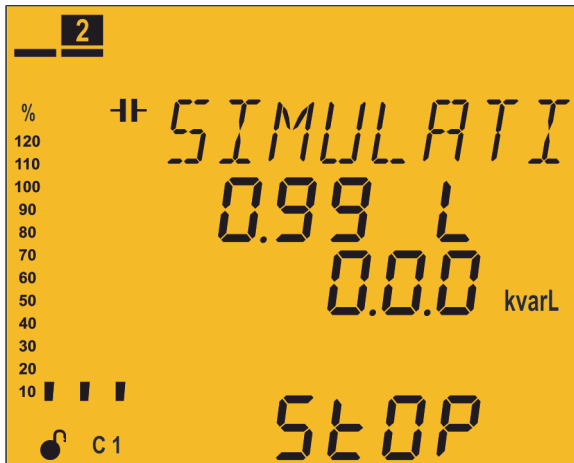

This screen can be accessed by pressing the  key for more than 3 seconds, in order to exit the configuration status.

This is an informative, non-editable screen.

The simulation screen provides certain information which can be used to decide to enter the measurement **RUN** status if the  key is pressed for 3 seconds or if no keys are pressed for 5 minutes, or to return to the configuration screens when pressing any of the other keys.

The screen shows the following information:

- ✓ Measurement of the $\cos \varphi$.
- ✓ Three-phase reactive power.
- ✓ The word *STOP*, as a reminder that the unit is still not in measurement status.
- ✓ Simulation of the steps that would be connected upon entering measurement status and of the analogue bar.

6.- TECHNICAL FEATURES

AC Power supply		
Rated voltage	100 ... 520 V ~	
Frequency	50 ... 60 Hz	
Consumption	Computer SMART III FAST 6	Computer SMART III FAST 12
	8 ... 14 VA	9... 15 VA
Installation category	CAT III 300 V	

Voltage measurement circuit	
Rated voltage (Un)	230 V P-N, 400 V P-P
Voltage measurement margin	20 to 300 V P-N, 35 to 520 V P-P
Frequency measurement margin	45 ... 65 Hz
Input impedance	660 kΩ
Minimum measurement voltage (Vstart)	20 V P-N, 35 V P-P
Installation category	CAT III 300 V

Current measurement circuit	
Nominal current (In)	.../5 A or .../1 A
Current measurement margin	1 to 120 % In
Minimum measurement current (Istart)	50 mA
Installation category	CAT III 300 V

Leakage current measurement circuit	
By means of an earth leakage transformer with a ratio of 500 turns	
Nominal current of the secondary	3 mA
Current measurement margin	10 mA to 1.5 A
Minimum measurement current (Istart)	10 mA

Measurement accuracy	UNE-EN 61557-12
Voltage measurement	0.5 % ± 1 digit
Current measurement	0.5 % ± 1 digit
Active power measurement	0.5% ± 2 digits
Reactive power measurement	1% ± 2 digits
Active energy measurement	Class 1
Reactive energy measurement	Class 2

Digital outputs				
Model	Computer SMART III FAST 6		Computer SMART III FAST 12	
Quantity	6	2	6	2
Type	OPTO MOS	NPN	OPTO MOS	NPN
Maximum voltage	24 V ---	24 V ---	24 V ---	24 V ---
Maximum current	0.15 A	50 mA	0.15 A	50 mA

Relay outputs	
Quantity	2 (fan, alarm)
Maximum voltage, open contacts	1 kV
Maximum current	1 A
Maximum switching power	2500 VA
Electrical life	30x10 ³ cycles
Mechanical working life	5x10 ⁶ cycles

Digital inputs		
Quantity	2	
Type	Potential-free contact	
Insulation	optoisolated	
User interface		
Display	Custom COG LCD	
Keys	Capacitive, 5 keys	
LED	4 LED	
Communications		
Type	RS-485	CPC-NET
Field bus	RS-485	RS-485
Communications protocol	Modbus RTU	Modbus RTU
Speed	9600 - 19200	9600 - 19200 - 38400
Stop bits	1 - 2	
Parity	none - even - odd	
Environmental features		
Operating temperature	-10°C to +55°C	
Storage temperature	-20°C to +70°C	
Relative humidity (with no condensation)	5 ... 95%	
Maximum altitude	2,000 m	
Protection degree	IP31 Front panel: IP51	
Mechanical features		
Dimensions (Figure 19)	144x144x78 mm	
Weight	575 g	
Enclosure	Self-extinguishing V0 plastic	
Assembly	Panel	

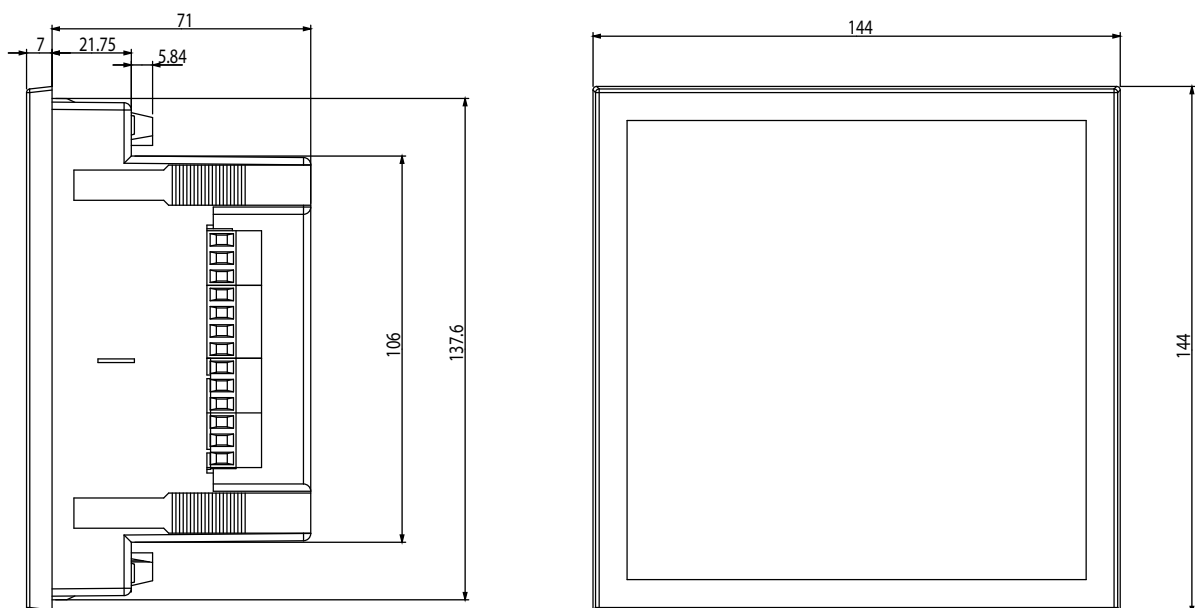

Figure 19: Dimensions of the Computer SMART III FAST.

Standards	
Safety requirements for electrical units for measurement, control and laboratory use.	UNE-EN 61010:2010
Electromagnetic compatibility (CEM)	UNE-EN 61000:2007
Electromagnetic compatibility (CEM). Part 6: Generic standards. Section 2: Generic immunity standards for industrial environments.	UNE-EN 61000-6-2:2005
Electromagnetic compatibility (CEM). Part 6-4: Generic standards. Emissions standard for industrial environments.	UNE-EN 61000-6-4:2005

7.- MAINTENANCE AND TECHNICAL SERVICE

In the case of any query in relation to device operation or malfunction, please contact the **CIRCUTOR, SA** Technical Support Service.

Technical Assistance Service

Vial Sant Jordi, s/n, 08232 - Viladecavalls (Barcelona)

Tel: 902 449 459 (España) / +34 937 452 919 (outside of Spain)

email: sat@circutor.com

8.- WARRANTY

CIRCUTOR guarantees its products against any manufacturing defect for two years after the delivery of the units.

CIRCUTOR will repair or replace any defective factory product returned during the guarantee period.



- No returns will be accepted and no unit will be repaired or replaced if it is not accompanied by a report indicating the defect detected or the reason for the return.
- The guarantee will be void if the units has been improperly used or the storage, installation and maintenance instructions listed in this manual have not been followed. "Improper usage" is defined as any operating or storage condition contrary to the national electrical code or that surpasses the limits indicated in the technical and environmental features of this manual.
- **CIRCUTOR** accepts no liability due to the possible damage to the unit or other parts of the installation, nor will it cover any possible sanctions derived from a possible failure, improper installation or "improper usage" of the unit. Consequently, this guarantee does not apply to failures occurring in the following cases:
 - Overvoltages and/or electrical disturbances in the supply;
 - Water, if the product does not have the appropriate IP classification;
 - Poor ventilation and/or excessive temperatures;
 - Improper installation and/or lack of maintenance;
 - Buyer repairs or modifications without the manufacturer's authorisation.

9.- CE CERTIFICATE



DECLARACIÓN UE DE CONFORMIDAD

La presente declaración de conformidad se expide bajo la exclusiva responsabilidad de CIRCUTOR con dirección en Vial Sant Jordi, s/n – 08232 Viladecavalls (Barcelona) España

Producto:

Reguladores energía reactiva trifásico. regulación, medida, control de fugas y comunicaciones

Serie:

Computer Smart III 6, Computer Smart III 12, Computer Smart III 14

Marca:

CIRCUTOR

EL objeto de la declaración es conforme con la legislación de armonización pertinente en la UE, siempre que sea instalado, mantenido y usado en la aplicación para la que ha sido fabricado, de acuerdo con las normas de instalación aplicables y las instrucciones del fabricante

2014/35/UE: Low Voltage Directive 2014/30/UE: Electromagnetic Compatibility Directive
2011/65/UE: RoHS2 Directive

Está en conformidad con la(s) siguiente(s) norma(s) u otro(s) documento(s) normativos(s):

IEC 62053-23:2003 Ed 1.0 IEC 61326-1:2012 Ed 2.0
IEC 61010-1:2010+AMD1:2016 CSV Ed 3.0 IEC 60947-1:2007+AMD1:2010+AMD2:2014 CSV Ed 5.2

Año de marcado "CE":

2014



EU DECLARATION OF CONFORMITY

This declaration of conformity is issued under the sole responsibility of CIRCUTOR with registered address at Vial Sant Jordi, s/n – 08232 Viladecavalls (Barcelona) Spain

Product:

Power Factor regulators. Regulation, measurement and protection all in one

Series:

Computer Smart III 6, Computer Smart III 12, Computer Smart III 14

Brand:

CIRCUTOR

The object of the declaration is in conformity with the relevant EU harmonisation legislation, provided that it is installed, maintained and used for the application for which it was manufactured, in accordance with the applicable installation standards and the manufacturer's instructions

2014/35/UE: Low Voltage Directive 2014/30/UE: Electromagnetic Compatibility Directive
2011/65/UE: RoHS2 Directive

It is in conformity with the following standard(s) or other regulatory document(s):

IEC 62053-23:2003 Ed 1.0 IEC 61326-1:2012 Ed 2.0
IEC 61010-1:2010+AMD1:2016 CSV Ed 3.0 IEC 60947-1:2007+AMD1:2010+AMD2:2014 CSV Ed 5.2

Year of CE mark:

2014



DECLARATION UE DE CONFORMITÉ

La présente déclaration de conformité est délivrée sous la responsabilité exclusive de CIRCUTOR dont l'adresse postale est Vial Sant Jordi, s/n – 08232 Viladecavalls (Barcelona) Espagne

Produit:

Régulateurs énergie réactive intelligents, mesure sur les 3 phases

Série:

Computer Smart III 6, Computer Smart III 12, Computer Smart III 14

Marque:

CIRCUTOR

L'objet de la déclaration est conforme à la législation d'harmonisation pertinente dans l'UE, à condition d'avoir été installé, entretenu et utilisé dans l'application pour laquelle il a été fabriqué, conformément aux normes d'installation applicables et aux instructions du fabricant

2014/35/UE: Low Voltage Directive 2014/30/UE: Electromagnetic Compatibility Directive
2011/65/UE: RoHS2 Directive

Il est en conformité avec la(les) suivante (s) norme(s) ou autre(s) document(s) réglementaire (s):

IEC 62053-23:2003 Ed 1.0 IEC 61326-1:2012 Ed 2.0
IEC 61010-1:2010+AMD1:2016 CSV Ed 3.0 IEC 60947-1:2007+AMD1:2010+AMD2:2014 CSV Ed 5.2

Année de marquage « CE »:

2014



Viladecavalls (Spain), 21/06/2017
General Manager: Ferran Gil Torné



CIRCUTOR, SA – Vial Sant Jordi, s/n
08232 Viladecavalls (Barcelona) Spain
(+34) 937 452 900 – info@circutor.com

(DE) **DECLARACIÓN CONFORMIDAD CE**

Vorliegende Konformitätserklärung wird unter alleiniger Verantwortung von CIRCUTOR mit der Anschrift, Vial Sant Jordi, s/n – 08232 Viladecavalls (Barcelona) Spanien, ausgestellt

Producto:

Dreiphasen-Blindleistungsregler. Regulierung, Messung, Ableitstrom- und Kommunikationsüberwachung

Serie:

Computer Smart III 6, Computer Smart III 12, Computer Smart III 14

Marke:

CIRCUTOR

Der Gegenstand der Konformitätserklärung ist konform mit der geltenden Gesetzgebung zur Harmonisierung der EU, sofern die Installation, Wartung und Verwendung der Anwendung seinem Verwendungszweck entsprechend gemäß den geltenden Installationsstandards und der Vorgaben des Herstellers erfolgt.

2014/35/UE: Low Voltage Directive 2014/30/UE: Electromagnetic Compatibility Directive 2011/65/UE: RoHS2 Directive

Es besteht Konformität mit der/den folgenden/folgenden Norm/Normen oder sonstigem/sonstiger Regelwerk/Regelwerken

IEC 62053-23:2003 Ed 1.0 IEC 61326-1:2012 Ed 2.0 IEC 61010-1:2010+AMD1:2016 CSV Ed 3.0 IEC 60947-1:2007+AMD1:2009+AMD2:2014 CSV Ed 5.2

Jahr der CE-Kennzeichnung:

2014

(PT) **DECLARAÇÃO DA UE DE CONFORMIDADE**

A presente declaração de conformidade é expedida sob a exclusiva responsabilidade da CIRCUTOR com morada em Vial Sant Jordi, s/n – 08232 Viladecavalls (Barcelona) Espanha

Produto:

Reguladores de energia reativa. Medida e compensação sobre as 3 fases da instalação

Série:

Computer Smart III 6, Computer Smart III 12, Computer Smart III 14

Marca:

CIRCUTOR

O objeto da declaração está conforme a legislação de harmonização pertinente na UE, sempre que seja instalado, mantido e utilizado na aplicação para a qual foi fabricado, de acordo com as normas de instalação aplicáveis e as instruções do fabricante.

2014/35/UE: Low Voltage Directive 2014/30/UE: Electromagnetic Compatibility Directive 2011/65/UE: RoHS2 Directive

Está em conformidade com a(s) seguinte(s) norma(s) ou outro(s) documento(s) normativo(s):

IEC 62053-23:2003 Ed 1.0 IEC 61326-1:2012 Ed 2.0 IEC 61010-1:2010+AMD1:2016 CSV Ed 3.0 IEC 60947-1:2007+AMD1:2009+AMD2:2014 CSV Ed 5.2

Ano de marcação "CE":

2014

(IT) **DICHIARAZIONE DI CONFORMITÀ UE**

La presente dichiarazione di conformità viene rilasciata sotto la responsabilità esclusiva di CIRCUTOR, con sede in Vial Sant Jordi, s/n – 08232 Viladecavalls (Barcelona) Spagna

prodotto:

Regolatori energia reattiva trifase. regolazione, misurazione, controllo di fughe e comunicazioni

Serie:

Computer Smart III 6, Computer Smart III 12, Computer Smart III 14

MARCHIO:

CIRCUTOR

L'oggetto della dichiarazione è conforme alla pertinente normativa di armonizzazione dell'Unione Europea, a condizione che venga installato, mantenuto e utilizzato nell'ambito dell'applicazione per cui è stato prodotto, secondo le norme di installazione applicabili e le istruzioni del produttore.

2014/35/UE: Low Voltage Directive 2014/30/UE: Electromagnetic Compatibility Directive 2011/65/UE: RoHS2 Directive

È conforme alle seguenti normative o altri documenti normativi:

IEC 62053-23:2003 Ed 1.0 IEC 61326-1:2012 Ed 2.0 IEC 61010-1:2010+AMD1:2016 CSV Ed 3.0 IEC 60947-1:2007+AMD1:2009+AMD2:2014 CSV Ed 5.2

Anno di marcatura "CE":

2014



Viladecavalls (Spain), 21/06/2017
General Manager: Ferran Gil Torné



CIRCUTOR, SA – Vial Sant Jordi, s/n
08232 Viladecavalls (Barcelona) Spain
(+34) 937 452 900 – info@circutor.com



DEKLARACJA ZGODNOŚCI UE

Niniejsza deklaracja zgodności zostaje wydana na wyłączną odpowiedzialność firmy CIRCUTOR z siedzibą pod adresem: Vial Sant Jordi, s/n – 08232 Viladecavalls (Barcelona) Hiszpania

produkt:

Regulator mocy biernej; regulacja, pomiar i ochrona w jednym

Seria:

Computer Smart III 6, Computer Smart III 12, Computer Smart III 14

marka:

CIRCUTOR

Przedmiot deklaracji jest zgodny z odnoszonymi wymaganiami prawodawstwa harmonizacyjnego w Unii Europejskiej pod warunkiem, że będzie instalowany, konserwowany i użytkowany zgodnie z przeznaczeniem, dla którego został wyprodukowany, zgodnie z mającymi zastosowanie normami dotyczącymi instalacji oraz instrukcjami producenta

2014/35/UE: Low Voltage Directive 2014/30/UE: Electromagnetic Compatibility Directive

2011/65/UE: RoHS2 Directive

Jest zgodny z następującą(y)mi normą(ami) lub innym(i) dokumentem(ami) normatywnym(i):

IEC 62053-23:2003 Ed 1.0 IEC 61326-1:2012 Ed 2.0
IEC 61010-1:2010-AMD1:2016 CSV Ed 3.0 IEC 60947-1:2007-AMD1:2010-AMD2:2014 CSV Ed 5.2

Rok oznakowania "CE":

2014



Viladecavalls (Spain), 21/06/2017
General Manager: Ferran Gil Torné

CIRCUTOR, SA

Vial Sant Jordi, s/n

08232 - Viladecavalls (Barcelona)

Tel.: (+34) 93 745 29 00 - Fax: (+34) 93 745 29 14

www.circutor.es central@circutor.com