

Battery Specification

Document Number & Revision

DSNC2040HD34

Description

Rechargeable Smart Lithium Ion Battery Pack

Inspired Energy Part Number For Battery

NC2040HD34

Statement Of Confidentiality

The information contained within this document is confidential and proprietary to Inspired Energy. This information should not, in whole or in part, be reproduced, disclosed or used except as expressly and duly authorized by Inspired Energy.

This information is descriptive only. No representation, guarantee or warranty of merchantability or fitness for purpose is made or implied. Specifications are subject to change without notice.



Specification Number	DSNC2040HD34
Specification Revision	1.2
Prepared By	NCN
Issue date	2/5/18

Battery Specification

TABLE OF CONTENTS

1. REVISION HISTORY	4
2. INTRODUCTION	4
2.1. SCOPE	4
2.2. BATTERY PACK OVERVIEW	4
2.3. GENERAL PRECAUTIONS	5
2.3.1. Handling	5
2.3.2. Charge & Discharge	5
2.3.3. Storage	5
2.3.4. Disposal	5
3. REQUIREMENTS	5
3.1. GENERAL REQUIREMENTS	5
3.1.1. Nominal Voltage	5
3.1.2. Rated Capacity	5
3.1.3. Initial Impedance	6
3.1.4. Discharge -20C to +60C	6
3.1.5. Charge 0C to +45C	7
3.1.6. Storage	8
3.1.7. Terminal Specifications	8
3.2. FUEL-GAUGE ELECTRONICS	8
3.2.1. Overview Of Operation	8
3.2.2. DC Specifications	10
3.2.3. Measurement Accuracy	10
3.2.3.1. Voltage	10
3.2.3.2. Temperature	10
3.2.3.3. Current	10
3.2.4. LCD Indication	10
3.3. SMBUS AND SBD PARAMETERS	11
3.3.1. Overview Of Operations	11
3.3.2. SMBus Logic Levels	11
3.3.3. SMBus Data Protocols	11
3.3.4. SMBus Host-to-Battery Message Protocol	11
3.3.4.1. Write Word	12
3.3.4.2. Read Word	12
3.3.4.3. Block Read	12
3.3.5. SMBus Battery-to-Charger Message Protocol	13
3.3.6. SMBus Battery Critical Message Protocol	13
3.3.7. Host To Battery Messages (Slave Mode)	13
3.3.8. Battery To Charger Messages (Master Mode)	15
3.3.9. Critical Messages (Master Mode)	15
3.3.10. Pack Calibration Cycle	16
3.4. PROTECTION ELECTRONICS	16
3.4.1. Overview Of Operation	16
3.4.2. Charge Protection	17
3.4.3. Discharge Protection	17



Specification Number	DSNC2040HD34
Specification Revision	1.2
Prepared By	NCN
Issue date	2/5/18

Battery Specification

3.4.4.	<i>Short-Circuit Protection</i>	17
3.5.	PASSIVE SAFETY PROTECTION	18
3.5.1.	<i>Overview Of Operation</i>	18
3.5.2.	<i>Thermal Fuse</i>	19
3.5.3.	<i>Slow-Blow Current Fuse (Logic Fuse)</i>	19
3.6.	MECHANICAL SPECIFICATIONS	19
3.6.1.	<i>Weight</i>	19
3.6.2.	<i>Mating Connector</i>	19
3.6.3.	<i>Date Code/Serial Number</i>	19
3.6.4.	<i>Packaging</i>	19
3.6.5.	<i>Mechanical Drawing</i>	20
3.7.	ENVIRONMENTAL/SAFETY SPECIFICATIONS	22
3.7.1.	<i>EMC And Safety</i>	22
3.8.	RELIABILITY	22
3.8.1.	<i>Life Expectancy</i>	22
3.8.2.	<i>Warranty</i>	22
3.8.3.	<i>Shelf Life</i>	22



Specification Number	DSNC2040HD34
Specification Revision	1.2
Prepared By	NCN
Issue date	2/5/18

Battery Specification

1. REVISION HISTORY

Revision	Release Date	Revisions	Issued By	Approved By
1.0	2/12/13	Released.	RAH	DB, LJ
1.1	1/26/16	Changed shipping s-o-c	LJ	LJ
1.2	2/5/18	Updated Discharge Limits.	NCN	JAB, RAH

2. INTRODUCTION

2.1. Scope

This specification describes the physical, functional and electrical characteristics of a rechargeable Lithium Ion battery pack supplied by Inspired Energy. This specification is the interface document between Inspired Energy and its customers. It is understood that the customer may create their own internal specification. However, this specification is the master that defines the battery’s operation. Battery packs produced will meet this specification.

2.2. Battery Pack Overview

This specification describes the physical, functional and electrical requirements for the NC2040HD34 Smart Battery including a rechargeable Lithium Ion battery and a Battery Management Module. The battery consists of (3) Lithium Ion rechargeable cells of 18650 size, assembled in a 3 series / 1 parallel (3S 1P) configuration. Each cell has an average voltage of 3.6V and a typical capacity of 3.4Ah giving a battery pack of 10.8V and 3.4Ah typical.

The battery is capable of communicating with host or the charger through the System Management Bus (SMBus). The battery is fully SMBus and SBDS Revision 1.1 compliant. Protection is provided for over-charge, over-discharge and short circuit. For redundancy, passive safety devices have been integrated into the pack to protect against over-current and over-temperature, and secondary over-voltage has been implemented with a logic-fuse and controller.

The battery pack comprises the individual elements as shown below.

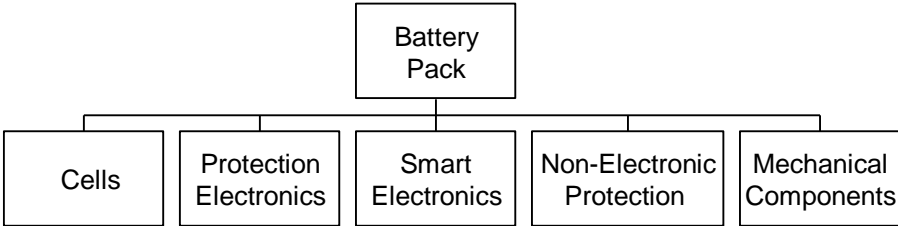



Specification Number	DSNC2040HD34
Specification Revision	1.2
Prepared By	NCN
Issue date	2/5/18

Battery Specification

2.3. General Precautions

2.3.1. Handling

- Avoid shorting the battery
- Do not immerse in water.
- Do not disassemble or deform the battery
- Do not expose to, or dispose of the battery in fire.
- Avoid excessive physical shock or vibration.
- Keep out of the reach of children.
- Never use a battery that appears to have suffered abuse.

2.3.2. Charge & Discharge

- Battery must be charged in appropriate charger only.
- Never use a modified or damaged charger.
- Specified product use only.

2.3.3. Storage

- Store in a cool, dry and well-ventilated area.

2.3.4. Disposal

- Regulations vary for different countries. Dispose of in accordance with local regulations.

3. REQUIREMENTS

3.1. General Requirements

3.1.1. Nominal Voltage

The battery nominal operating voltage is 10.8V.

3.1.2. Rated Capacity

The initial capacity is $\geq 3230\text{mAh}$ (based on a CV charge of $12.6\text{V} \pm 50\text{mV}$ with a current limit of 1500mA and a 680mA discharge to 7.5V @ 25C, within 1 hour of charge).



Specification Number	DSNC2040HD34
Specification Revision	1.2
Prepared By	NCN
Issue date	2/5/18

Battery Specification

3.1.3. Initial Impedance

The internal impedance of a fully charged battery shall be < 315mΩ when measured across the positive and negative battery terminals at 1kHz at 20°C.

3.1.4. Discharge -20C to +60C

Discharge Temperature Limits: As shown below, ≤ 80%RH

The battery shall be capable of continuous discharge within the Operating Boundary as shown in the graph below.

Host devices should be designed for a controlled shutdown following battery notification of termination by the battery sending TERMINATE_DISCHARGE alarm, prior to protection circuit cut-off.

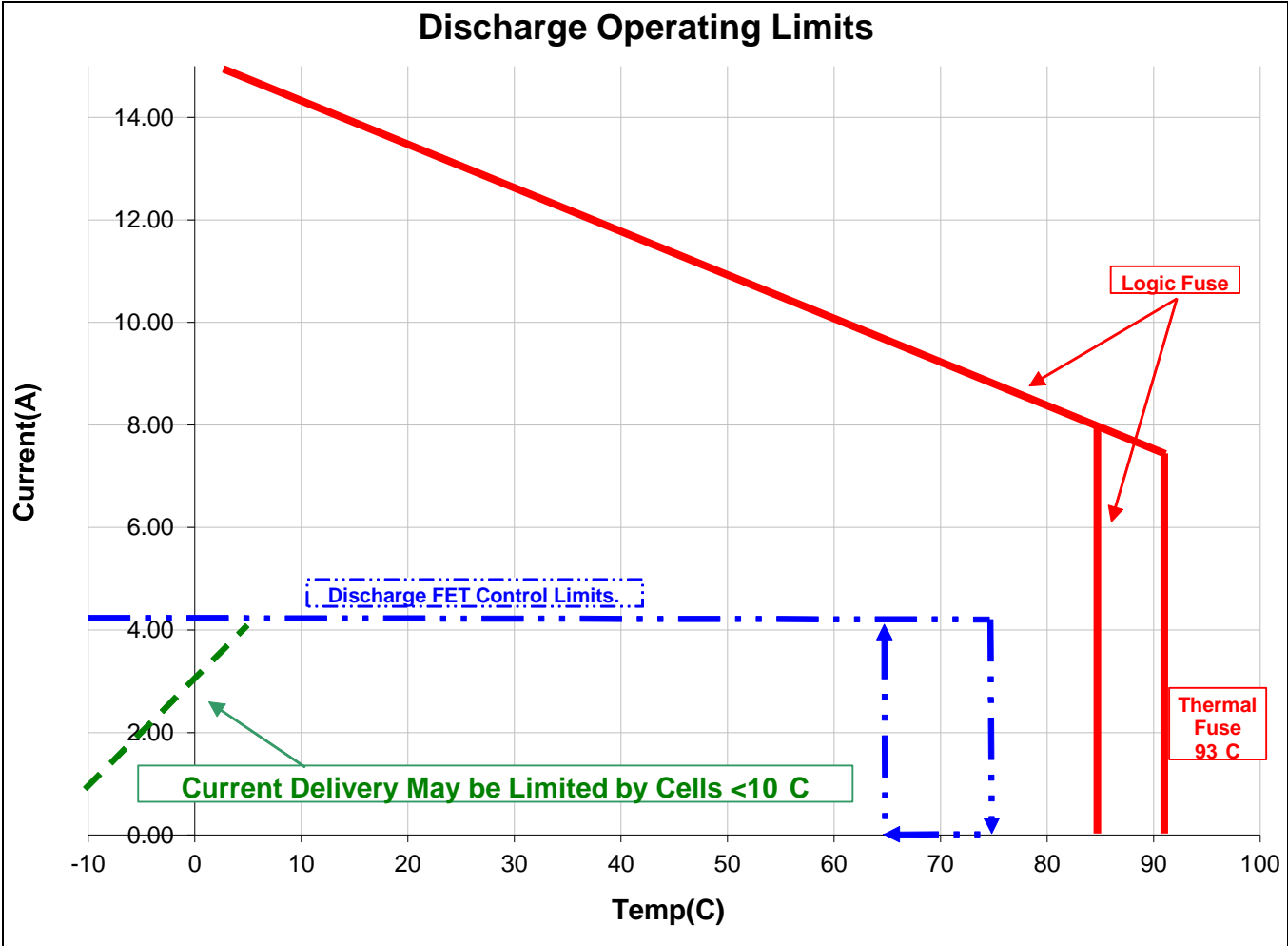



Specification Number	DSNC2040HD34
Specification Revision	1.2
Prepared By	NCN
Issue date	2/5/18

Battery Specification

3.1.5. Charge 0C to +45C

Charge Temperature Limits: As Shown below, $\leq 80\%RH$

The battery shall be capable of continuous charge at 12.6V, as shown in the graph below. A dedicated level II or level III smart battery charger is required to charge the battery. Using this type of charger, the battery will request appropriate charging Voltage and Current from the smart battery charger.

The FULLY_CHARGED bit in the BatteryStatus() will be set when the charging current tapers down under 113mA while charging at 12.6V.

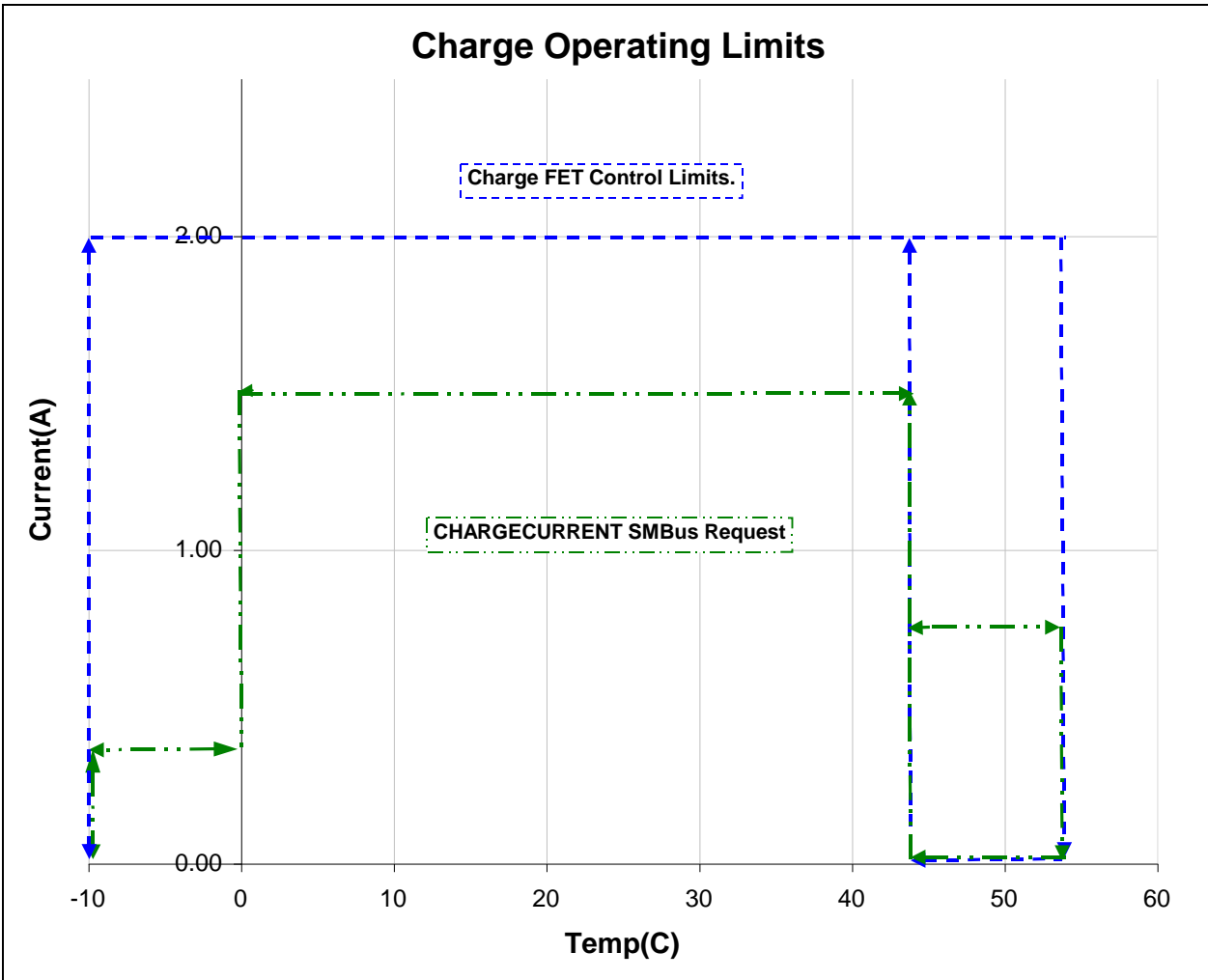

NOTE: If not charging & temperature > 45C then the battery enters Charge-Inhibit where ChargingCurrent() = 0 until temperature $\leq 44C$.



Specification Number	DSNC2040HD34
Specification Revision	1.2
Prepared By	NCN
Issue date	2/5/18

Battery Specification

3.1.6. Storage

Storage Temperature Limits: -20°C to 60°C , $\leq 80\% \text{RH}$

The battery packs should be stored in an environment with low humidity, free from corrosive gas at a recommended temperature range $<21^{\circ}\text{C}$. Extended exposure to temperatures above 45°C could degrade battery performance and life.

3.1.7. Terminal Specifications

See Mechanical Drawing for orientation of contacts J1-1,5

Terminal	Legend	Description
1	(+)	Positive side of battery
2	(C)	SMBus Clock. Internally a $1\text{M}\Omega$ resistor is connected between (C) and (-).
3	(D)	SMBus Data. Internally a $1\text{M}\Omega$ resistor is connected between (D) and (-).
4	(T)	$300\Omega \pm 5\%$ resistor connected between (T) and (-).
5	(-)	Negative Side Of Battery

- A key slot is also present on each pack for mechanical alignment adjacent to the positive terminal.
- The SMBus Clock and data lines require separate pull-ups to system logic voltage, NOT the battery voltage. Typically a $15\text{K}\Omega$ pull-up resistor is used, but please refer to the SMBus Specification for additional information.

3.2. Fuel-Gauge Electronics

3.2.1. Overview Of Operation

The battery is capable of communicating with host or the charger through the System Management Bus (SMBus). The battery is fully SMBus and SBDS Revision 1.1 compliant. An 8-bit Reduced Instruction Set CPU (RISC) is used to process the core algorithms and perform operations required for battery monitoring. Charge and discharge current, cell and pack voltages, and pack temperature are all measured using an integrated analog to digital converter at 14-bit to 16-bit effective resolution.

The battery pack uses a system level approach to optimize the performance of the battery. It's primary functions are to provide fuel gauging and software based charge control, and to ensure safe operation throughout the life cycle of the battery.

Specification Number	DSNC2040HD34
Specification Revision	1.2
Prepared By	NCN
Issue date	2/5/18

Battery Specification

The fuel gauge determines the State-Of-Charge (SOC) by integrating the input and output current and using impedance tracking to accurately track the available capacity of the attached battery. To achieve the desired fuel-gauging accuracy, high-performance analog peripherals are used to monitor capacity change, battery impedance, open-circuit voltage and temperature. These factors are continually applied to account for battery non-linearity and environmental conditions. This approach provides the user a meaningful and repeatable capacity measure with minimal risk of overstating run time. Visually, the SOC can be obtained from the 5-segment LCD panel on the end of the battery opposite to the connector. This LCD panel is always-on.

Charge control is used to provide optimal and safe charging requests to an SMBus level II or level III charger.

The system has three modes of operation; normal, sleep and shutdown. In normal mode, measurements, calculations, protection decisions and data updates are made on 1 sec intervals. Between these intervals, the electronics enters a reduced power mode. Sleep mode is entered when the system senses no host or charger present. While in this mode, battery parameters continue to be monitored at regular intervals. The system will continue in this mode until it senses host activity (communications or current flow). Shutdown mode occurs when the battery voltage falls below 2.3V/parallel cell group. In this mode, parasitic current is reduced to a minimum by shutting down the micro-controller and all associated circuitry. If this should happen, the battery will require an initial low current charge to bring the battery voltage back up before normal operation will resume.

The battery pack block diagram is shown below.

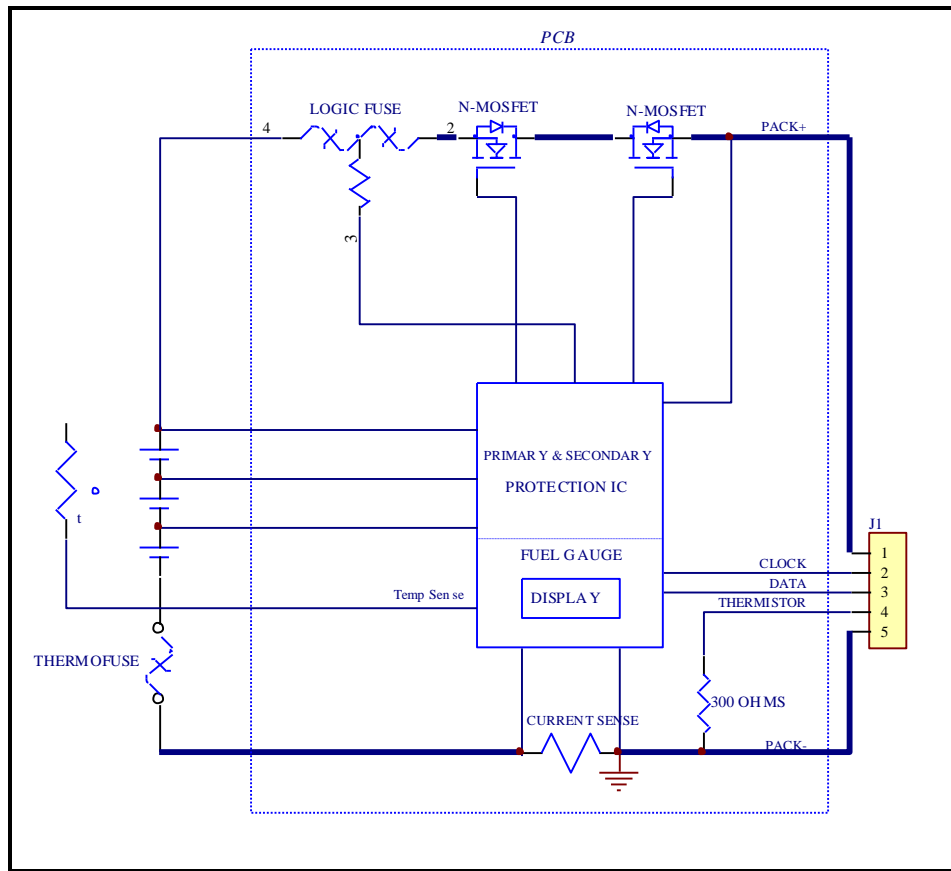



Specification Number	DSNC2040HD34
Specification Revision	1.2
Prepared By	NCN
Issue date	2/5/18

Battery Specification

3.2.2. DC Specifications

Parameter	Limits	Remarks
Active mode current consumption	<745uA	When a host is detected (charging, discharging or communications).
Standby mode current consumption	<200uA	When no host activity is detected.
Shut-down mode current consumption	<1uA	Any cell voltage falls below 2300mV.

3.2.3. Measurement Accuracy

3.2.3.1. Voltage

The voltage measurements have a resolution of 1mV. The absolute accuracy of the reading is $\pm 0.7\%$ over the operating range. Note that measurements are made at the cell stack (not the pack connector). Therefore internal resistance drops due to the shunt, safety components, and contact resistance are not taken into consideration.

3.2.3.2. Temperature

The internal pack temperature is measured by a on-chip temperature sensor in thermal contact with the cell stack. Temperature readings have a resolution of 0.1°K. The absolute accuracy is $\pm 3^\circ\text{K}$ over an operating range of -20°C to +80°C.

3.2.3.3. Current

The current measurements have a resolution of 1mA. The absolute accuracy of the reading is $\pm 0.7\%$ or $\pm 3\text{mA}$ whichever is greater over the operating range. A guard band has been imposed around zero current (-3mA to +3mA).

3.2.4. LCD Indication

The battery can directly display the capacity information. The battery capacity is displayed as the relative SOC. Each LCD segment represents 20 percent of the full charge capacity. The LCD pattern definition is given in the table below. If the battery voltage is low, there will be no LCD indication. During charge, the most significant segment will blink.

Capacity	LCD Segments				
	1	2	3	4	5
0% - 19%					
20% - 39%					
40% - 59%					
60% - 79%					
80% - 100%					



Specification Number	DSNC2040HD34
Specification Revision	1.2
Prepared By	NCN
Issue date	2/5/18

Battery Specification

3.3. SMBus and SBD Parameters

3.3.1. Overview Of Operations

The battery is fitted with a microprocessor and associated circuitry for communication with an external host device and/or smart battery charger. Reference should be made to the following specifications when reading this section:

- System Management Bus Specification (Rev 1.1, Dec 11, 1998) with the exception that it is necessary to wait at least 150uS between battery message transactions.
- Smart Battery Data Specification (Rev 1.1, Dec 15, 1998)
- Smart battery Charger Specification (Rev 1.0, June 27, 1996)

3.3.2. SMBus Logic Levels

Symbol	Parameter	Limits		Units
		Min	Max	
V_{il}	Data/Clock input low voltage	-0.3	0.8	V
V_{ih}	Data/Clock input high voltage	2.1	5.5	V
V_{ol}	Data/Clock output low voltage		0.4	V

3.3.3. SMBus Data Protocols

SMBus Interface complies with SBS Specification Version 1.1. The battery pack includes a simple bi-directional serial data interface. A host processor uses the interface to access various battery pack registers.

The interface uses a command-based protocol, where the host processor sends the battery address command byte to the battery pack. The command directs the battery pack to either store the next data received to a register specified command byte or output the data specified by the command byte.

3.3.4. SMBus Host-to-Battery Message Protocol

The Bus Host communicates with the battery pack using one of three protocols:

- Write Word
- Read Word
- Read Block



Specification Number	DSNC2040HD34
Specification Revision	1.2
Prepared By	NCN
Issue date	2/5/18

Battery Specification

3.3.4.1. Write Word

The first byte of a Write Word access is the command code. The next two Bytes are the data to be written. In this example the master asserts the slave device address followed by the write bit. The device acknowledges and the master delivers the command code. The slave again acknowledges before the master sends the data word (low byte first). The slave acknowledges each byte according to the I²C specification, and the entire transaction is finished with a stop condition.

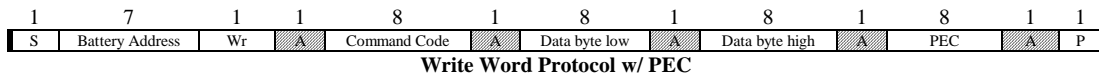
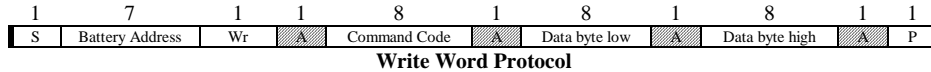

SMBus Host (master) Smart Battery (slave)

3.3.4.2. Read Word

Reading data is slightly more complex than writing data. First the host must write a command to the slave device. Then it must follow that command with a repeated start condition to denote a read from that device's address. The slave then returns two bytes of data.

Note that there is not a stop condition before the repeated start condition, and that a "Not Acknowledge" signifies the end of the read transfer.

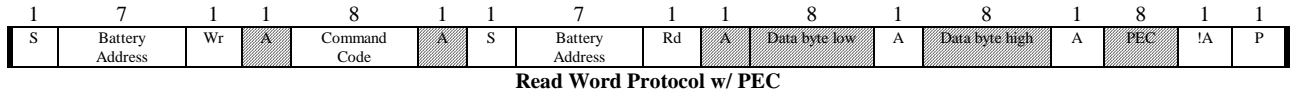
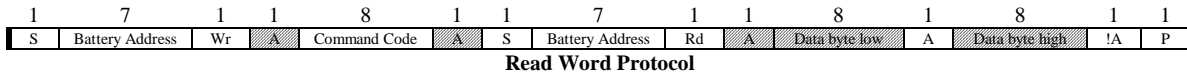

SMBus Host (master) Smart Battery (slave)

3.3.4.3. Block Read

The Block Read begins with a slave address and a write condition. Then it must follow that command with a repeated start condition to denote a read from that device's address. After the repeated start the slave issues a byte count that describes how many data bytes will follow in the message. If a slave had 20 bytes to send, the first byte would be the number 20 (14h), followed by the 20 bytes of data. The byte count may not be 0. A Block Read can transfer a maximum of 32 bytes.

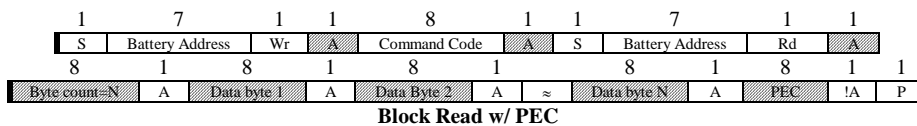
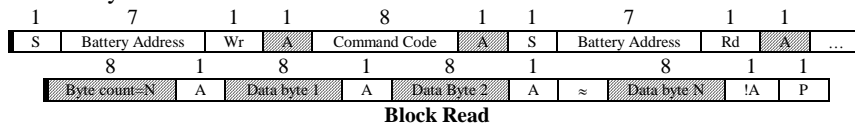

SMBus Host (master) Smart Battery (slave)



Specification Number	DSNC2040HD34
Specification Revision	1.2
Prepared By	NCN
Issue date	2/5/18

Battery Specification

3.3.5. SMBus Battery-to-Charger Message Protocol

The Smart Battery, acting as an SMBus master will dynamically alter the charger characteristics of the Smart Charger, behaving as an SMBus slave using the SMBus Write Word protocol. Communication begins with the Smart Charge’s address, followed by a Command Code and a two byte value. The Smart Charger adjust its output to correspond with the request.

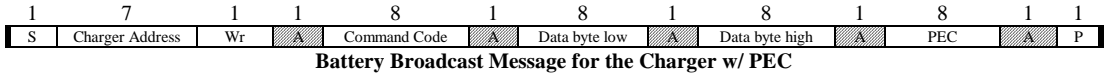
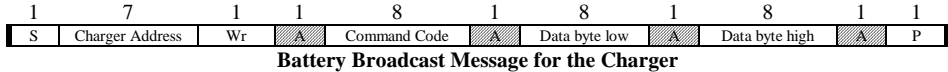

□ Smart Battery (master) ▨ Smart Charger (slave)

3.3.6. SMBus Battery Critical Message Protocol

A Smart Battery to SMBus Host or Smart Charger message is sent using the SMBus Write Word protocol. Communication begins with the SMBus Host’s or Smart Battery Charger’s address, followed by the Smart Battery’s address which replaces the Command Code. The SMBus Host or Smart Charger can now determine that the Smart Battery was the originator of the message and that the following 16 bits are its status.

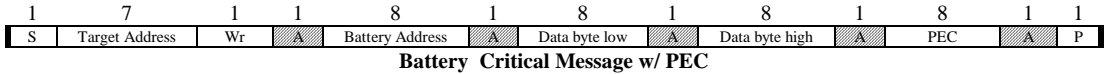
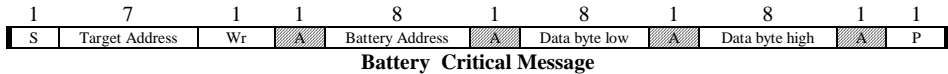

□ Smart Battery (master) ▨ Smart Host or Smart Charger (slave)

3.3.7. Host To Battery Messages (Slave Mode)

The Host acting in the role of bus master uses the read word, write word, and read block protocols to communicate with the battery, operating in slave mode.



Specification Number	DSNC2040HD34
Specification Revision	1.2
Prepared By	NCN
Issue date	2/5/18

Battery Specification

Host-to-Battery Messages

Function	Command Code	Description	Unit	Access	Default (POR)
ManufacturerAccess()	0x00			r/w	
RemainingCapacityAlarm()	0x01	Remaining Capacity Alarm Threshold .	mAh	r/w	340
RemainingTimeAlarm()	0x02	Remaining Time Alarm Threshold.	minutes	r/w	10
BatteryMode()	0x03	Battery Operational Modes.	Bit flags	r/w	0x0081
AtRate()	0x04	This function is the first half of a two-function call-set used to set the AtRate value used in calculations made by the AtRateTimeToFull(), AtRateTimeToEmpty(), and AtRateOK() functions.	mA	r/w	0
AtRateTimeToFull()	0x05	Returns the predicted remaining time to fully charge the battery at the AtRate() value.	minutes	r	65535
AtRateTimeToEmpty()	0x06	Returns the predicted remaining operating time if the battery is discharged at the AtRate() value.	minutes	r	65535
AtRateOK()	0x07	Returns a Boolean value that indicates whether or not the battery can deliver the AtRate value of additional energy for 10 seconds. If the AtRate() value is zero or positive, the AtRateOK() function will ALWAYS return TRUE.	boolean	r	1
Temperature()	0x08	Returns the pack's internal temperature.	0.1 °K	r	
Voltage()	0x09	Returns the battery's voltage (measured at the cell stack)	mV	r	
Current()	0x0a	Returns the current being supplied (or accepted) through the battery's terminals.	mA	r	0
AverageCurrent()	0x0b	Returns a rolling average based upon the last 64 samples of current.	mA	r	0
MaxError()	0x0c	Returns the expected margin of error.	percent	r	100
RelativeStateOfCharge()	0x0d	Returns the predicted remaining battery capacity expressed as a percentage of FullChargeCapacity().	percent	r	0
AbsoluteStateOfCharge()	0x0e	Returns the predicted remaining battery capacity expressed as a percentage of DesignCapacity().	percent	r	0
RemainingCapacity()	0x0f	Returns the predicted remaining battery capacity.	mAh	r	0
FullChargeCapacity()	0x10	Returns the predicted battery capacity when fully charged.	mAh	r	
RunTimeToEmpty()	0x11	Returns the predicted remaining battery life at the present rate of discharge.	minutes	r	65535
AverageTimeToEmpty()	0x12	Returns the rolling average of the predicted remaining battery life.	minutes	r	65535
AverageTimeToFull()	0x13	Returns the rolling average of the predicted remaining time until the battery reaches full charge.	minutes	r	65535
ChargingCurrent()	0x14	Returns the battery's desired charging rate.	mA	r	1500
ChargingVoltage()	0x15	Returns the battery's desired charging voltage.	mV	r	12600
BatteryStatus()	0x16	Returns the battery's status word.	Bit flags	r	0x2C0
CycleCount()	0x17	Returns the number of charge/discharge cycles the battery has experienced. A charge/discharge cycle is defined as: an amount of discharge approximately equal to the value of DesignCapacity.	cycles	r	0
DesignCapacity()	0x18	Returns the theoretical capacity of the new battery.	mAh	r	3400
DesignVoltage()	0x19	Returns the theoretical voltage of a new battery.	mV	r	10800
SpecificationInfo()	0x1a	Returns the version number of the SBDS the battery pack supports, as well as voltage and current scaling information.	Formatted word	r	0x0031
ManufacturerDate()	0x1b	Returns the date the electronics was manufactured.	Formatted word	r	
SerialNumber()	0x1c	Returns the electronics serial number.	number	r	
Reserved	0x1d - 0x1f			r	
ManufacturerName()	0x20	Returns a character array containing the manufacture's name.	string	r	INSPIREDE
DeviceName()	0x21	Returns a character array that contains the battery's name.	string	r	NC2040HD34
DeviceChemistry()	0x22	Returns a character array that contains the battery's chemistry.	string	r	LION
ManufacturerData()	0x23	Returns data specific to the manufacture.		r	



Specification Number	DSNC2040HD34
Specification Revision	1.2
Prepared By	NCN
Issue date	2/5/18

Battery Specification

3.3.8. Battery To Charger Messages (Master Mode)

The battery, acting in the role of a bus master, uses the write word protocol to communicate with the charger, operating in slave mode. If the CHARGER_MODE bit in BatteryMode() is clear, the Battery will broadcast Charger request information every 10 to 60 seconds.

Battery-to-Charger Messages

Function	Command Code	Description	Unit	Access
ChargingCurrent()	0x14	Sends the desired charging rate to the battery charger	mA	W
ChargingVoltage()	0x15	Sends the desired charging voltage to the battery charger	mV	W

3.3.9. Critical Messages (Master Mode)

Whenever the Battery detects a critical condition, it takes the role of a bus master and sends AlarmWarning() message to the Host and/ or Charger. The Battery broadcasts the AlarmWarning() message at 10 second intervals until the critical condition(s) has been corrected.

Battery Critical Messages

Function	Command Code	Description	Unit	Access
AlarmWarning()	0x16	This message is to the host and/or charger to notify them that one or more alarm conditions exist.	Formatted word	W



Specification Number	DSNC2040HD34
Specification Revision	1.2
Prepared By	NCN
Issue date	2/5/18

Battery Specification

Alarm Bit Definitions

Bit	Battery Status	Set When:	Action When Set:	Cleared When:
15	OVER_CHARGD_ALARM	RemainingCapacity() exceeds <i>FullChargeCapacity()</i> + 300mAh .	Stop charging.	A continuous discharge of $\geq 300\text{mAh}$.
14	TERMINATE_CHARGE_ALARM	Primary Charge Termination, Cell (COV), Over-Current Charge (OCC), Over-Temp Charge (OTC) conditions. COV = 4300mV OCC = 2000mA OTC = 58°C	Stop charging.	RelativeStateOfCharge() $\leq 95\%$, COV, OCC or OTC recovery threshold. COV recovery $\leq 4150\text{mV}$ OCC recovery $\leq 200\text{mA}$ for 70sec OTC recovery $\leq 56^\circ\text{C}$
13	Reserved			
12	OVER_TEMP_ALARM	Over-Temp Charge (OTC) or Over-Temp discharge (OTD) condition. OTC=58°C OTD=75°C	Appropriate FET will be disabled to prevent further action.	OTC or OTD recovery threshold. OTC recovery = 56°C OTD recovery = 65°C
11	TERMINATE_DISCHARGE_ALARM	RelativeStateOfCharge() $\leq 0\%$, Cell (CUV, Over-Current Discharge (OCD), Over-Temp Discharge (OTD) conditions. CUV = 2400mV OCD = -4250mA OTD = 75°C	Stop discharging.	RelativeStateOfCharge() $\geq 1\%$, CUV, OCD or OTD recovery threshold. CUV recovery $\geq 3000\text{mV}$ OCD recovery $\geq -200\text{mA}$ for 70sec OTD recovery $\leq 65^\circ\text{C}$
10	Reserved			
9	REMAINING_CAPACITY_ALARM (User settable)	RemainingCapacity() < RemainingCapacityAlarm().	User defined.	RemainingCapacityAlarm() = 0 or is \leq RemainingCapacity().
8	REMAINING_TIME_ALARM (User settable)	AverageTimeToEmpty() < RemainingTimeAlarm().	User defined.	RemainingTimeAlarm() = 0 or \leq AverageTimeToEmpty().

Status Bit Definitions

Bit	Battery Status	Set When:	Action When Set:	Cleared When:
7	INITIALIZED		None.	
6	DISCHARGING	Battery is not in charge mode.	None.	Battery is in charging mode.
5	FULLY CHARGED	When the battery detects a primary charge termination.	Stop charging.	RelativeStateOfCharge() $\leq 95\%$.
4	FULLY DISCHARGED	RelativeStateOfCharge() $\leq 0\%$.	Stop discharging.	RelativeStateOfCharge() $\geq 20\%$.

3.3.10. Pack Calibration Cycle

The fuel-gauge uses the Impedance Track Technology to measure and calculate the available charge in battery cells. The achievable accuracy is better than 1% error over the lifetime of the battery. Max Error increases by 1% in 20 cycles, e.g., only occasionally is a full charge/discharge learning cycle required to maintain high accuracy.

3.4. Protection Electronics

3.4.1. Overview Of Operation

Electronic circuitry is permanently connected within the battery pack to prevent damage if either the charger or host device fails to function correctly. The circuitry also protects the battery if an illegal current source is placed across the battery terminals, or an illegal load is connected. Redundant levels of protection have been implemented (the primary protection levels are auto-resettable and the secondary are non-resettable).



Specification Number	DSNC2040HD34
Specification Revision	1.2
Prepared By	NCN
Issue date	2/5/18

Battery Specification

3.4.2. Charge Protection

Over-Voltage:

The primary protection circuit will prevent the battery from charging if any cell voltage $\geq 4300\text{mV}$. Then, once all cell voltages are $\leq 4200\text{mV}$, it will allow charging again.

The secondary protection circuit will prevent the battery from charging if any cell voltage $\geq 4.45\text{V} \pm 0.05\text{V}$ by blowing a power path logic fuse. The fuse is non-re-settable rendering the battery pack non-functional.

Over-temp:

The primary protection circuit also provides over-temperature protection and will prevent the battery from charging at temperatures $\geq 54^\circ\text{C}$ (see paragraph 3.1.5 for ChargeCurrent() request). Then, once the battery temperature has cooled to $\leq 45^\circ\text{C}$, it will again allow charging.

Over-Current:

The primary protection circuit also provides continuous over-current protection and will prevent the battery from charging at current $\geq 2.0\text{A}$. Then, once the average charge current is $\leq 200\text{mA}$ for 70sec, the battery will re-test the over-current condition, and again allow charging.

3.4.3. Discharge Protection

Under-Voltage:

The primary protection circuit will prevent the battery from being further discharged once any cell voltage reaches 2400mV. Then, once all cell voltages are $\geq 3000\text{mV}$, it will allow discharge again.

Over-temp:

The primary protection circuit also provides over-temperature protection and will prevent the battery from discharging at temperatures $\geq 75^\circ\text{C}$. Then, once the battery temperature has cooled to $\leq 65^\circ\text{C}$, it will again allow discharging.

If the battery reaches 85°C for any reason the secondary protection circuit will blow the in-line power path logic fuse. The fuse is non-re-settable rendering the battery pack non-functional.

Over-Current:

The primary protection circuit also provides continuous over-current protection and will prevent the battery from discharging at current $\geq 4.25\text{A}$. Then, once the average discharge current $\leq 200\text{mA}$ for 70sec, the battery will re-test the over-current condition, and again allow discharging.

3.4.4. Short-Circuit Protection

The primary protection circuit will prohibit the discharge of the battery if a short-circuit is placed across the battery + / - terminals. Then, once the average discharge current $\leq 1\text{mA}$ for 70sec, the battery will re-test the short-circuit condition, and again allow discharging.

Specification Number	DSNC2040HD34
Specification Revision	1.2
Prepared By	NCN
Issue date	2/5/18

Battery Specification

The pack is design to withstand reasonable in-rush currents without resetting the electronics and without interrupting the discharge cycle. The following graph illustrates the short-circuit/in-rush set points as implemented:

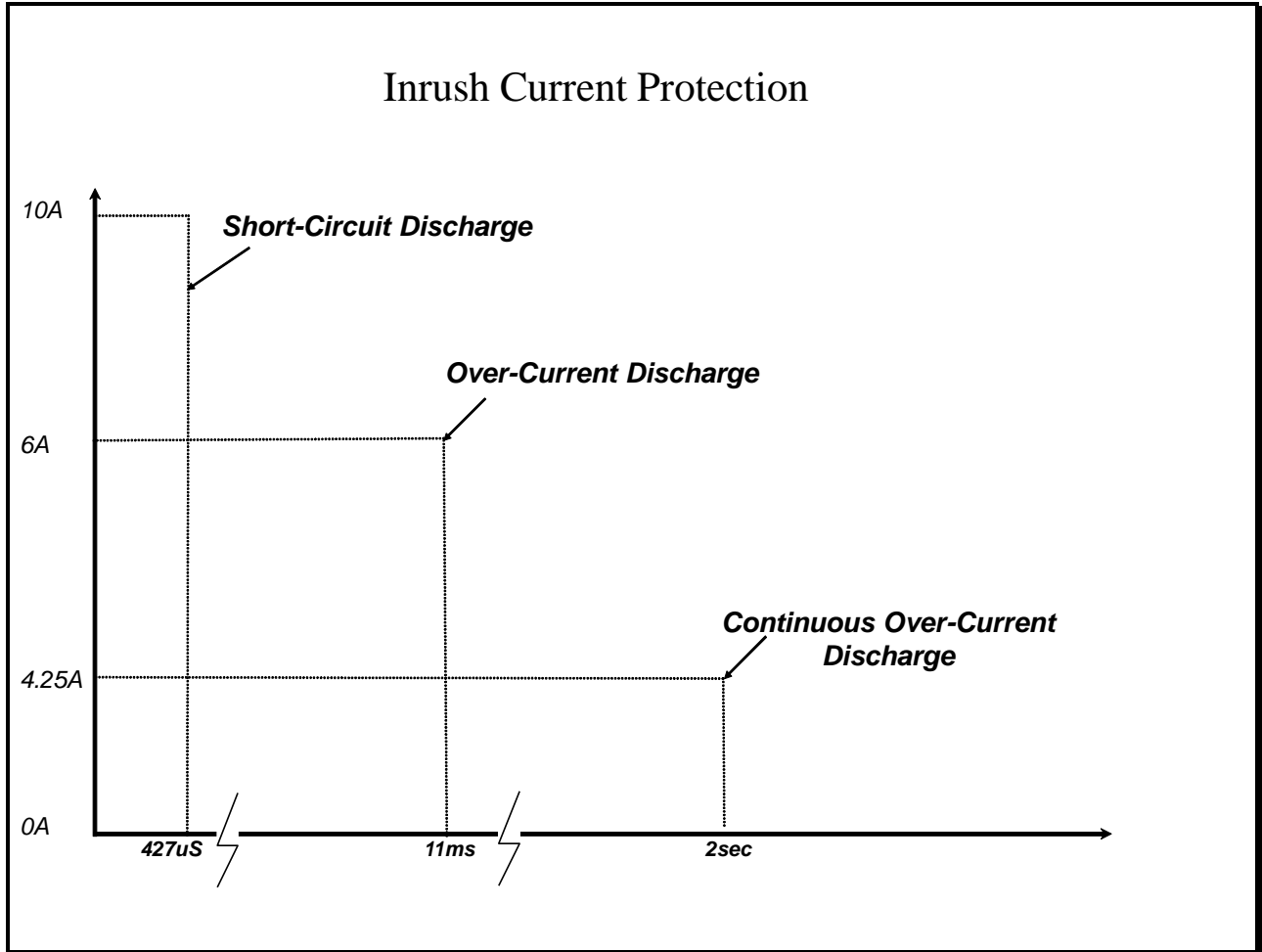

3.5. Passive Safety Protection

3.5.1. Overview Of Operation

The battery pack is fitted with additional components to protect it against abusive charge and discharge conditions. These are in addition to the electronic protection.



Specification Number	DSNC2040HD34
Specification Revision	1.2
Prepared By	NCN
Issue date	2/5/18

Battery Specification

3.5.2. Thermal Fuse

A Thermal Fuse is fitted in series with the charge/ discharge path to protect the battery from over temperature. This device goes open circuit if the cell case temperature reaches the fuse's temperature rating of 93°C (+0°C, -5°C). The fuse is non-re-settable rendering the battery pack non-functional.

3.5.3. Slow-Blow Current Fuse (Logic Fuse)

A current slow-blow fuse is assembled in series with the battery pack to protect the battery pack against abusive over current over-load. The hold current is rated at 12A for 4 hours (minimum@25C). The fuse is non-re-settable rendering the battery pack non-functional.

3.6. Mechanical Specifications

3.6.1. Weight

Approximately 0.184 Kg.

3.6.2. Mating Connector

The recommended interconnection mating male connector is AMP P/N 5787422-1 or 5787446-1.

3.6.3. Date Code/Serial Number

IE YYWWRR

SN SSSSS XZZAh

IE = Inspired Energy Newberry facility

YY = Calendar Year

WW = Calendar Week

RR = Battery revision

SSSSS = Serial Number

X = the cell supplier

ZZAh = the stored energy of the battery in Amp hours

3.6.4. Packaging

The batteries are packaged in bulk.



Battery Specification

Specification Number	DSNC2040HD34
Specification Revision	1.2
Prepared By	NCN
Issue date	2/5/18

3.6.5. Mechanical Drawing

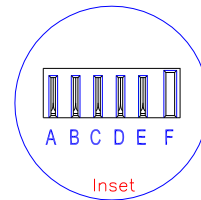

Inset

- Terminals
- A - Negative
 - B - Temperature
 - C - Data
 - D - Clock
 - E - Positive
 - F - Key



Battery Specification

Specification Number	DSNC2040HD34
Specification Revision	1.2
Prepared By	NCN
Issue date	2/5/18

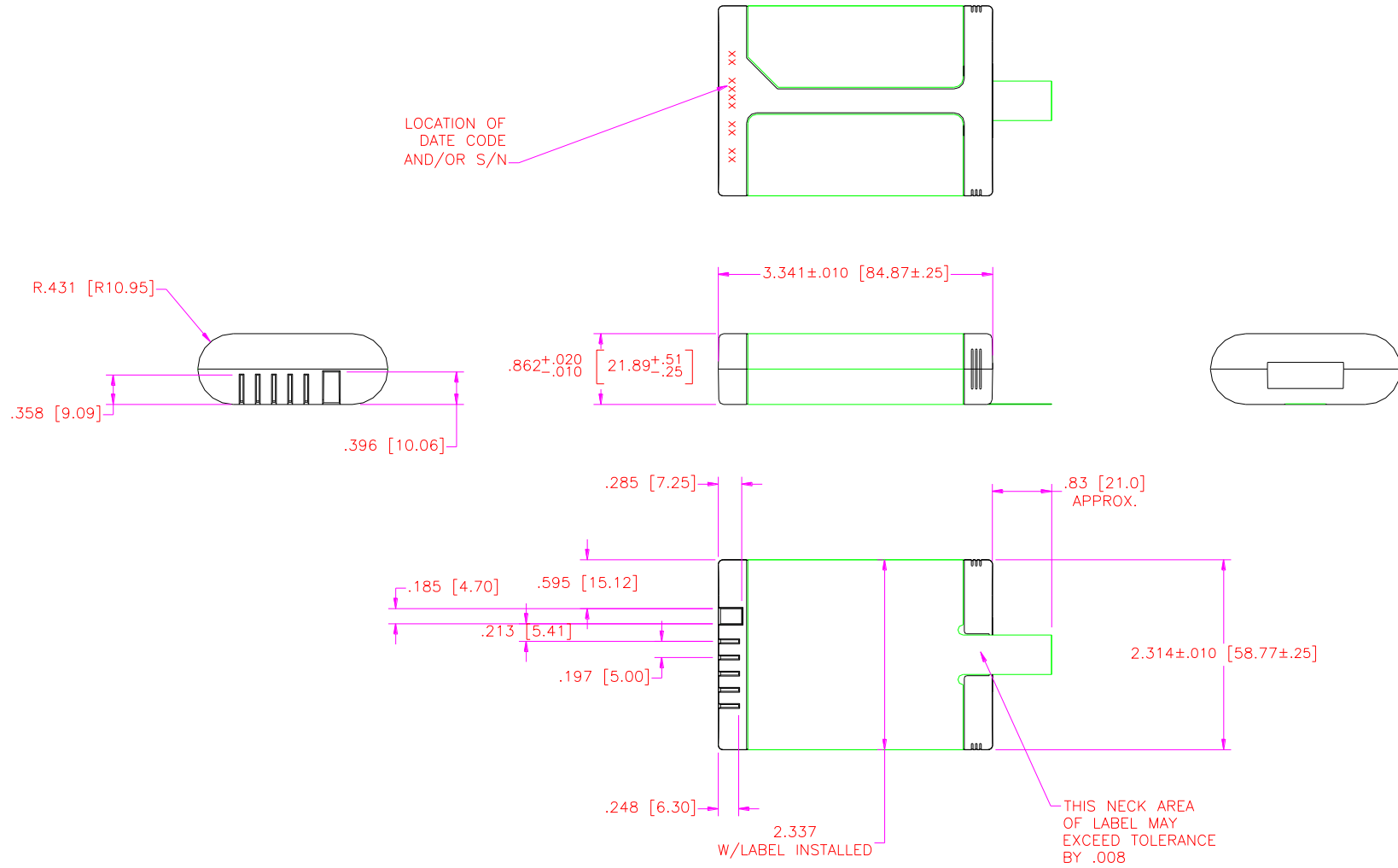



Specification Number	DSNC2040HD34
Specification Revision	1.2
Prepared By	NCN
Issue date	2/5/18

Battery Specification

3.7. Environmental/Safety Specifications

3.7.1. EMC And Safety

The battery complies with the following:

- CE Directive
- EMC Directive
- Battery Recycling Directive
- “RoHS2” & “REACH” Directives
- “WEEE” Directive

The battery has been tested in accordance with the UN Manual of tests and Criteria part III subsection 38.3 - more commonly known as the UN T1-T8 Transportation tests; and has been found to comply with the stated criteria. [USDOT-E7052]

The battery has the following approvals and the pack will be labeled according:

- CE
- FCC Part 15 Class B

3.8. Reliability

3.8.1. Life Expectancy

Given normal storage & usage, user can expect the battery to deliver 1026mAh or more after 300 charge/discharge cycles where the charge phase is CC/CV 1500mA, 12.6±0.05V and the discharge is 680mA down to 2.5V/Cell at 25°C.

3.8.2. Warranty

Inspired Energy maintains a high quality standard. All products are warranted against defects in workmanship, material and construction. The warranty period is one (1) year from the date of shipment from Inspired Energy.

3.8.3. Shelf Life

The batteries are shipped from Inspired Energy with between 20% and 30% rated capacity and this provides a minimum of 6 months shelf life, when stored at 25°C. If the storage temperature exceeds 25°C over the 6-month period then the shelf life will be reduced and provisions should be made to recharge the battery periodically.

In order to prevent parasitic drain on the battery, the electronics will go into a shutdown mode if any cell voltage \leq 2300mV. If this should happen, the battery pack will require an initial low charge to activate the electronics prior to the implementation of the normal charge. Any SMBus version 1.0, or higher, compatible charger is capable of providing this initial pre-charge.