

Magnescale

Digital Gauge General Catalog

SPEED X PRECISION

Magnescale

SPEED X PRECISION



Digital Gauge

Magnescale Co., Ltd.

Magnescale Co., Ltd.

Shinagawa Intercity Front 6F, 2-14-14, Konan, Minato-ku, Tokyo 108-0075, Japan

Headquarters	: 45 Suzukawa, Isehara-shi, Kanagawa 259-1146, Japan	TEL.+81 (0)463 92 1011	FAX.+81 (0)463 92 1012	
International Sales Department	: 45 Suzukawa, Isehara-shi, Kanagawa 259-1146, Japan	TEL.+81 (0)463 92 7971	FAX.+81 (0)463 92 7978	E-mail : info-mgs-eng@magnescale.com
Magnescale Americas Inc.	: 5740 Warland Drive, Cypress, CA 90630, USA	TEL.+1 (562)594 5060	FAX.+1 (562)594 5061	E-mail : info-am@magnescale.com
Magnescale Europe GmbH	: Antoniusstrasse 14, 73249 Wernau, Germany	TEL.+49(0)7153 934 291	FAX.+49(0)7153 934 299	E-mail : info-eu@magnescale.com
Customer Support & Service Department	: 45 Suzukawa, Isehara-shi, Kanagawa 259-1146, Japan	TEL.+81 (0)463 92 2132	FAX.+81 (0)463 92 3090	E-mail : info-css@magnescale.com

<http://www.magnescale.com>

The contents of this literature are as of Jun. 2014

This catalog is printed with soy ink.

MGS-DG-1406-EN-C

摺動力

Magnescape's advanced ball-spline construction allows for smoother measurements while also increasing side-load capacity, torsion resistance and performance up to 60 million strokes.

This innovative new construction allows for high precision measurements even in the most severe environments.

This is the new DK-S Series.

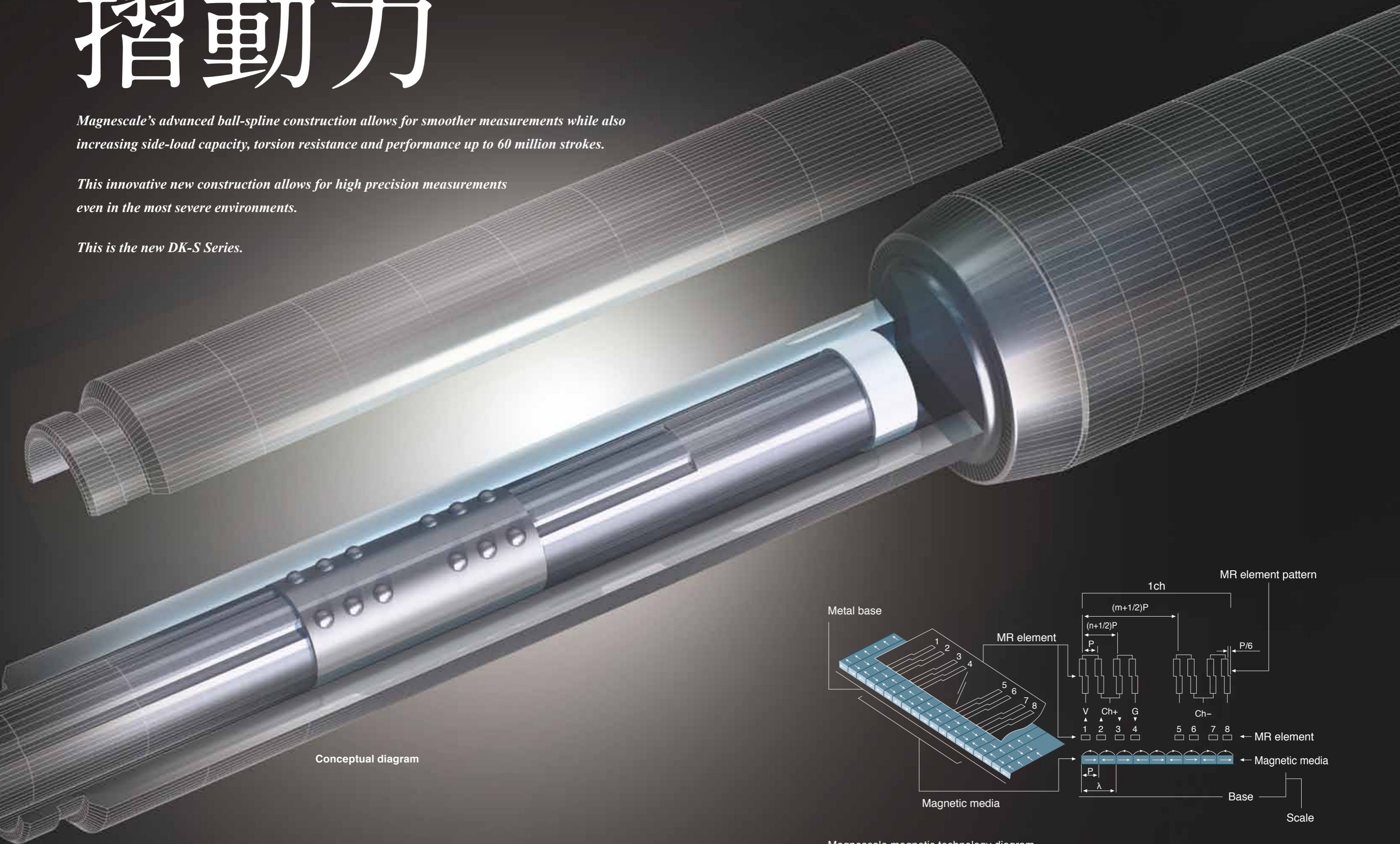

Conceptual diagram

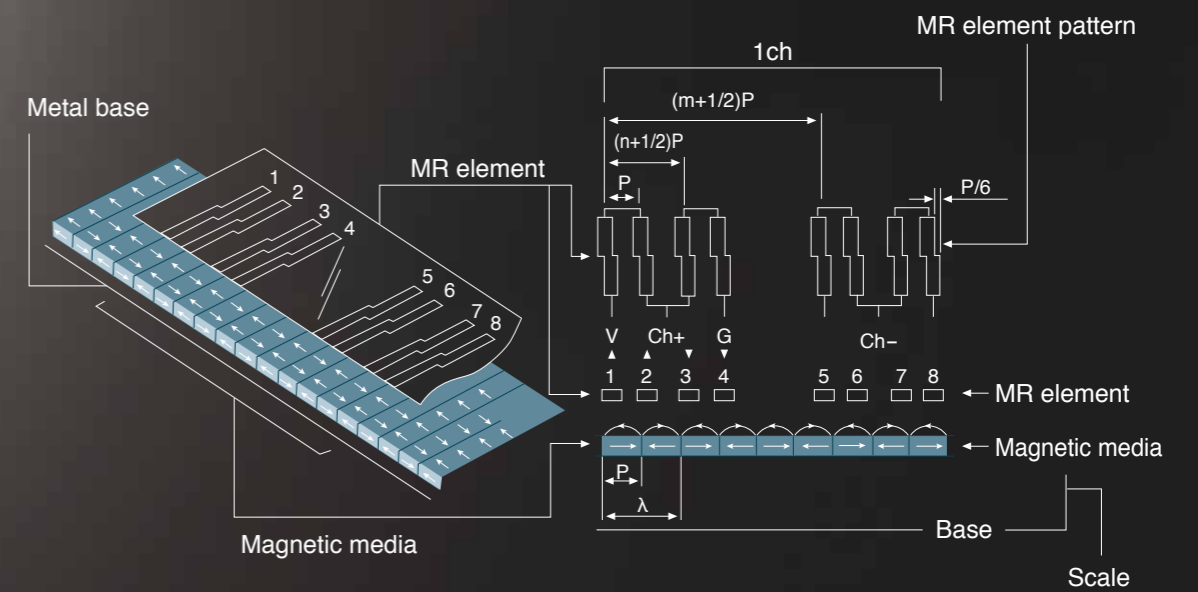

Magnescape magnetic technology diagram

Digital Gauge

Features & Superiority

DK SERIES

Digital Gauge

DK800S Series

Adapts bearings of new construction superior in sliding force and durability. It has slim shape whose main body size is $\varnothing 8$ mm and is high-precision digital gauge suitable for automatic measurements.

- Achieved number of strokes: 60 million
- Maximum resolution: $0.1 \mu\text{m}$
- Response Speed: 250 m/min (at resolution of $0.5 \mu\text{m}$)
- Adopt: High-flex cable (standard)
- Adopt: IP67 rating with bellows
- Linear encoder technology allows high precision measuring over the entire range.

DK Series

High rigidity $\varnothing 20$ mm body is suitable for harsh environments. Also, it enables high response speed in automatic measurements.

- According to varied materials to be measured, measuring force can be selected.
- Available in lengths up to 205mm with $0.5 \mu\text{m}$ resolution.
- Magnetic feeler tips equipped as standard make it easy to integrate into machines. (DK155/205)
- High-flex cable (standard): 250 m/min (at resolution of $0.5 \mu\text{m}$)
- High-flex cable (standard)
- Linear encoder technology allows high precision measuring over the entire range.

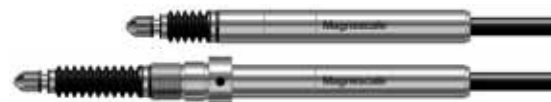

DT SERIES

Digital Gauge

Easy integration into machines with compact square body.

- Compact size and high rigidity

It is suitable for general purpose and automatic measurements.



LT SERIES

Counter

Compact LT Series counters of DIN size

- Current, maximum and minimum, and P-P value measuring function
- Comparator
- 2-axis ADD/SUB function
- BCD/RS-232C input/output
- Reference point function



LY SERIES

Counter

Multifunctional counters

- Optional expansion boards available (LY71)
- BCD output (LY71)
- Comparator (Relay, open collector output) (LY71)
- RS232-C Output (LY72)



MG SERIES

Interface Network

Multipoint measurement
Intelligent Network Systems: MG40 series











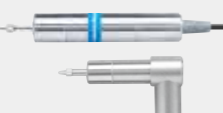

- Equipped with Ethernet interface as standard and supporting CC-Link

Unit: MG10/20/30 series

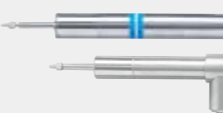
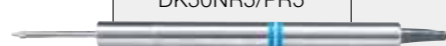
- Equipped with RS-232C interface as standard

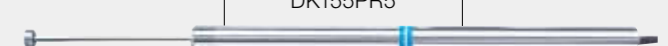

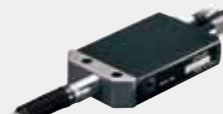
Lineup

Measuring range Resolution	5 mm	10 mm	12 mm	25 mm	30 mm	32 mm	50 mm	100 mm	110 mm	155 mm	205 mm
0.1 μm	DK805SAR/SALR DK805SAFR/SAFLR DK805SBR/SBLR DK805SBFR/SBFLR  P.12		DK812SAR/SALR DK812SAFR/SAFLR DK812SAVR DK812SBR/SBLR DK812SBFR/SBFLR DK812SBVR  P.13		DK830SR/SLR/SVR  P.14						
0.5 μm	DK805SAR5/SALR5 DK805SAFR5/SAFLR5 DK805SBR5/SBLR5 DK805SBFR5/SBFLR5  P.12	DK10NR5/PR5/PLR5  P.15	DK812SAR5/SALR5 DK812SAFR5/SAFLR5 DK812SAVR5 DK812SBR5/SBLR5 DK812SBFR5/SBFLR5 DK812SBVR5  P.13	DK25NR5/PR5 /NLR5/PLR5  P.15			DK50NR5/PR5  P.16	DK100NR5/PR5  P.16	DK110NLR5 (Stand and balancer are optional.)  P.18	DK155PR5  P.17	DK205PR5  P.17
1 μm			DT512N/P  P.20								
5 μm			DT12N/P  P.20			DT32N/NV/P/PV  P.21					

Application

Height, flatness, and inclination measurements

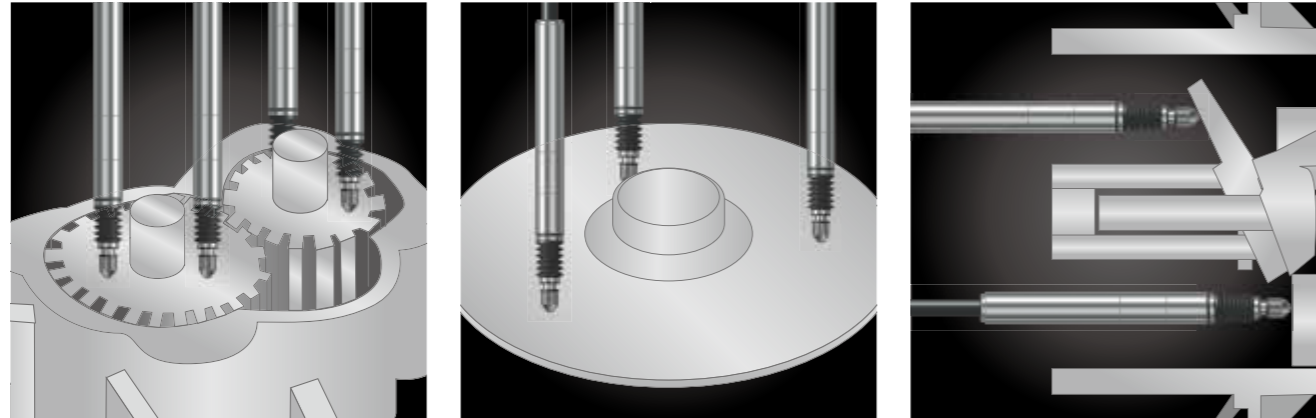

Assembled part measurement and shim selection

Flatness measurement of compact motors

Thickness and Flexure measurement of compressor parts

- $\phi 8\text{mm}$ body of the DK800S allows for multiple measurements in tight spaces at narrow measuring pitches.
- Magnetic technology ensures consistent measurements, even in harsh environments.
- Measurements can be taken immediately upon turning up.

Others

- Cylinder block flatness measurement
- Bearing height measurement
- Toe and alignment test
- Crimp-on terminal caulking height
- Thread height
- Turbine blade shape measurement
- Camber measurement of die-cast chassis parts, etc.

Thickness and inner and outer diameter measurements

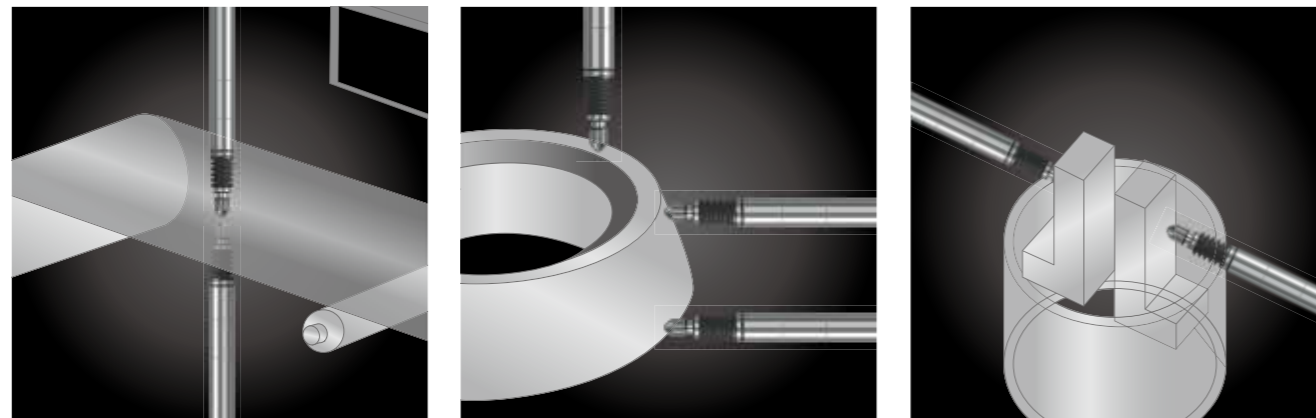

Film thickness measurement

Tapered roller bearing measurement

Bearing inner diameter measurement

- Digital measurement system assures full-stroke accuracy and supports multiproduct lines.
- Magnetic technology ensures consistent measurements, even in harsh environments.
- The DK-S Series has been achieved 60 million strokes, ensuring years of service.

Others

- CVT belt thickness measurement
- Metal plate and resin plate thickness measurement
- Steel ball diameter measurement
- Measurements on a surface grinding machine
- Shim thickness measurement
- Gasket thickness measurement, etc.

Deflection and shape measurement

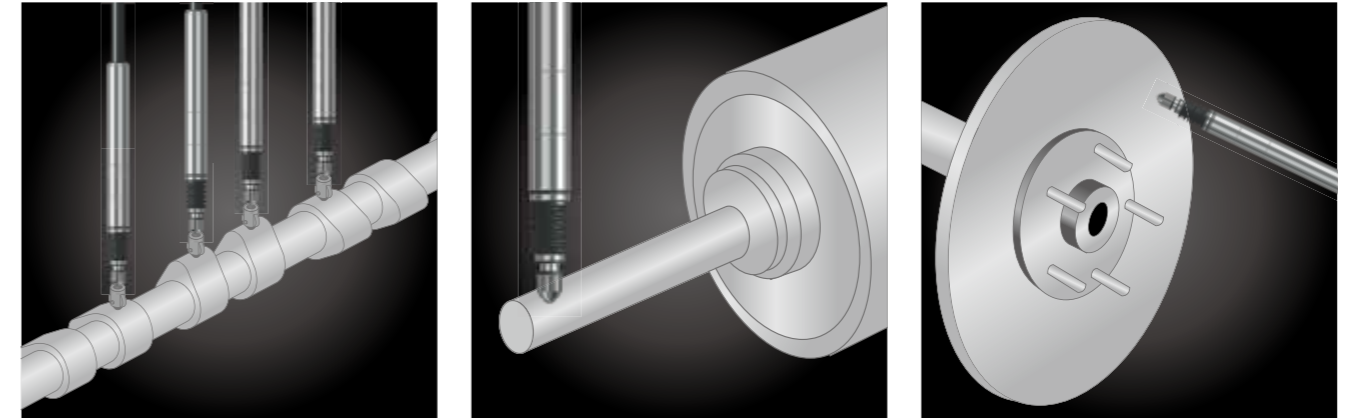

Cam shaft run-out and shape measurement

Motor shaft run-out measurement

Disk run-out measurement

- The new construction of spindle bearings increases both side-load capacity and torque resistance.
- Digital data output allows for real-time measurements.
- The DK-S Series has been achieved 60 million strokes, ensuring years of service.

Others

- Crank shaft journal run-out measurement
- Drive shaft or propeller shaft run-out measurement
- Bearing part run-out measurement, etc.

Displacement and stop position measurement

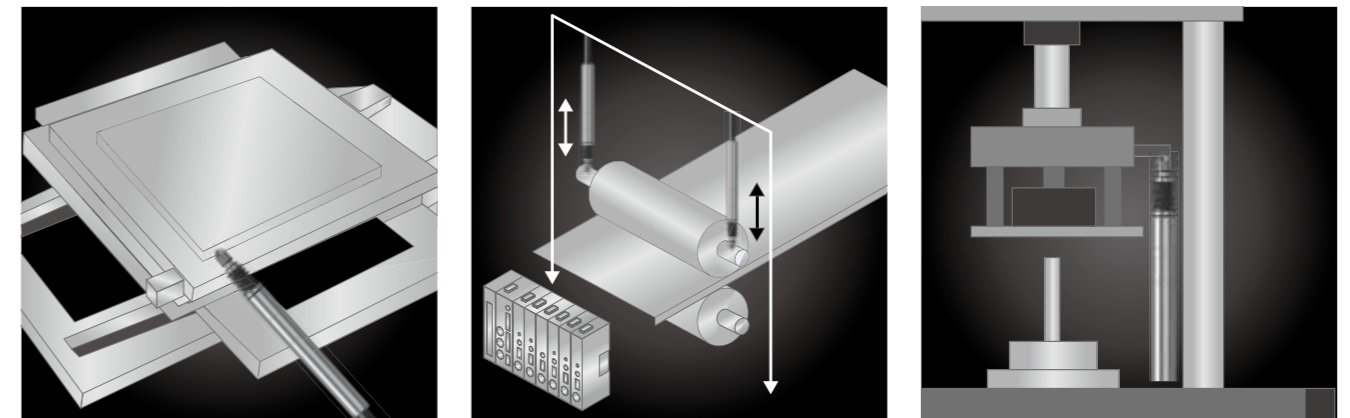

Work alignment measurement

Roller-to-roller gap measurement

Pressing machine's or injection molding machine's stop position measurement

- Magnetic technology assures protection against impact resistance.
- Measurements can be taken immediately upon turning up.
- Real-time digital data output allows gauges to be used for position control applications in a full closed-loop system.

Others

- Top and bottom dead center control of piston parts
- Measurement of material strength (such as camber)
- Measurement of press-fit part's press-fit amount
- Coater's nozzle height measurement, etc.

System

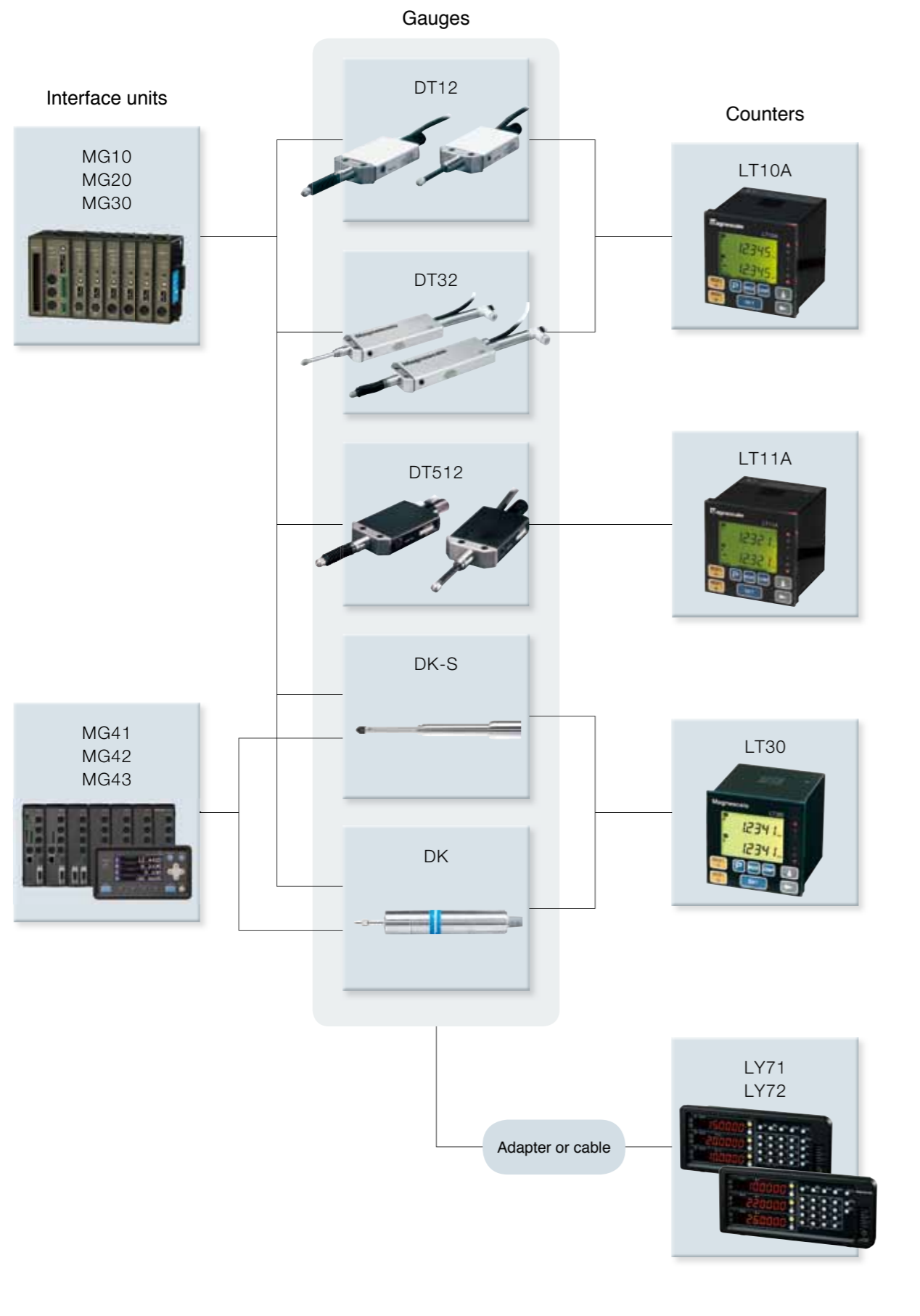

Gauges

Description of digital gauge model

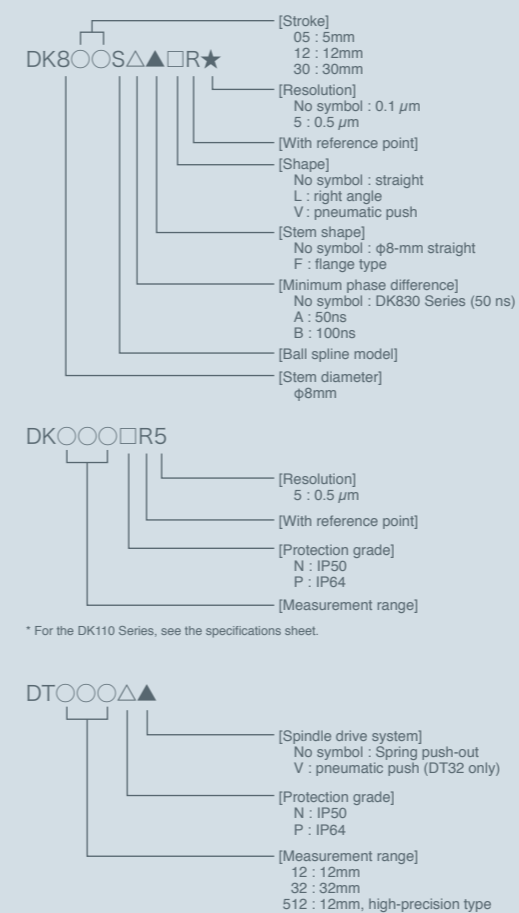

DK805S	12
DK812S	13
DK830S	14
DK10/25	15
DK50/100	16
DK155/205	17
DK110	18
DT512/12	20
DT32	21
MT12/13/14	22
U Series	23

DK DK805S

Resolution **0.1 μm** Resolution **0.5 μm** Stem **φ8** Stroke **5mm** Output **A/B phase**

* DK805SAR/DK805SAR5/DK805SBR/DK805SBR5



DK805SAR/DK805SAR5
DK805SBR/DK805SBR5

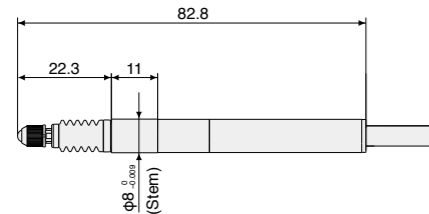

* Upon installation, clamp the stem.

DK805SALR/DK805SALR5
DK805SBLR/DK805SBLR5

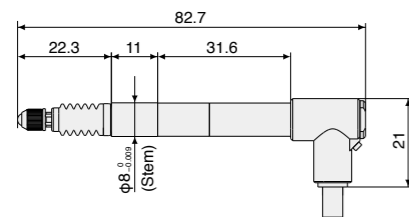

* Upon installation, clamp the stem.

DK805SAFR/DK805SAFR5
DK805SBFR/DK805SBFR5

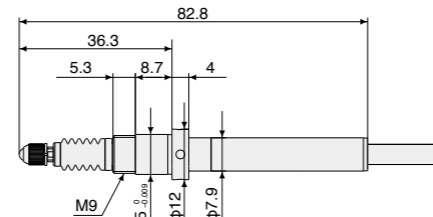

DK805SAFLR/DK805SAFLR5
DK805SBFLR/DK805SBFLR5

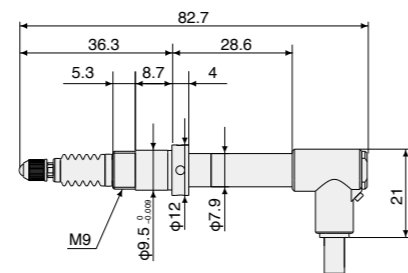

Unit: mm

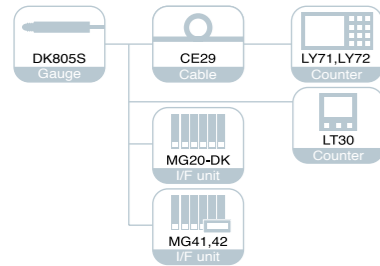

Model	High-resolution models		General-purpose resolution models	
	DK805SAR, DK805SALR DK805SAFR, DK805SAFLR	DK805SBR, DK805SBLR DK805SBFR, DK805SBFLR	DK805SAR5, DK805SALR5 DK805SAFR5, DK805SAFLR5	DK805SBR5, DK805SBLR5 DK805SBFR5, DK805SBFLR5
Measuring range	5 mm			
Maximum resolution	0.1 μm		0.5 μm	
Accuracy (at 20°C/68°F)	1 μm		1.5 μm	
Measuring force (at 20°C/68°F)	Upward: 0.35±0.25 N Horizontal: 0.40±0.25 N Downward: 0.45±0.25 N			
Maximum response speed	80 m/min	42 m/min	250 m/min	100 m/min
Reference point	Position at spindle movement of 1 mm			
Reference-point response speed	Same as the noted maximum response speed			
Output	A/B/reference point Voltage-differential line driver output (conforming to EIA-422)			
Spindle drive system	Spring push Vacuum suction (DK805SALR/SAFLR/SBLR/SBFLR/SALR5/SAFLR5/SBLR5/SBFLR5)			
Number of cycles tested ¹	60 million			
Protection grade ²	Straight model: IP66, right-angle model: IP64 (IP67 ³)			
Vibration resistance	20 to 2000 Hz 100 m/s ²			
Impact resistance	1000 m/s ² 11 ms			
Operating temperature	0 to 50 °C			
Storage temperature	-20 to 60 °C			
Power supply	5 VDC±5 %			
Power consumption	1 W			
Mass ⁴	Approx. 30 g			
Output cable length	2.4 m			
Feeler	Carbide ball tip, Mounting screw M2.5		Steel ball tip, Mounting screw M2.5	
Accessories	Instruction Manual, +P M4 x 5 screw (2pc), tightening nut, clamp spanner, wave washer, mounting pin 1 each (DK8**S**F** only) Hose elbow 1 pc (DK8**S**L** only), one spanner			

¹ Under specific test conditions defined by Magnescale Co., Ltd. ² Excluding the interpolation box and connector
³ When φ4 mm tube is connected for right-angle model ⁴ Excluding cable section and interpolation box

DK DK812S

Resolution **0.1 μm** Resolution **0.5 μm** Stem **φ8** Stroke **12mm** Output **A/B phase**

* DK812SAR/DK812SAR5/DK812SBR/DK812SBR5



DK812SAR/DK812SAR5
DK812SBR/DK812SBR5

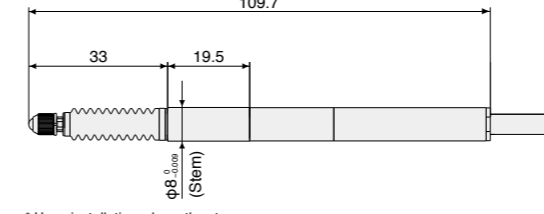

* Upon installation, clamp the stem.

DK812SALR/DK812SALR5
DK812SBLR/DK812SBLR5

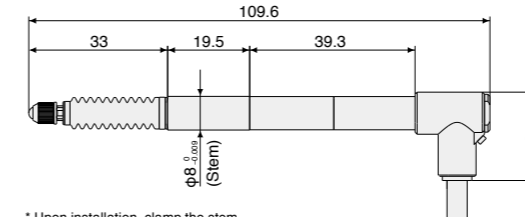

* Upon installation, clamp the stem.

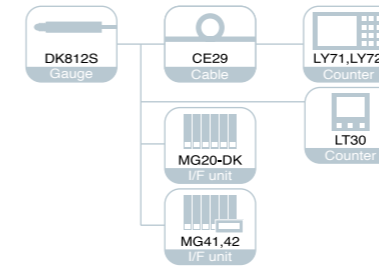

Model	High-resolution models		General-purpose resolution models	
	DK812SAR, DK812SALR DK812SAFR, DK812SAFLR DK812SAVR	DK812SBR, DK812SBLR DK812SBFR, DK812SBFLR DK812SBVR	DK812SAR5, DK812SALR5 DK812SAFR5, DK812SAFLR5 DK812SAVR5	DK812SBR5, DK812SBLR5 DK812SBFR5, DK812SBFLR5 DK812SBVR5
Measuring range	12 mm			
Maximum resolution	0.1 μm		0.5 μm	
Accuracy (at 20°C/68°F)	1 μm		1.5 μm	
Measuring force (at 20°C/68°F)	Upward: 0.4±0.3 N Horizontal: 0.5±0.3 N Downward: 0.6±0.3 N			
Maximum response speed	80 m/min	42 m/min	250 m/min	100 m/min
Reference point	Position at spindle movement of 1 mm			
Reference-point response speed	Same as the noted maximum response speed			
Output	A/B/reference point Voltage-differential line driver output (conforming to EIA-422)			
Spindle drive system	Spring push	Pneumatic push (DK812SAVR/SBVR/SAVR5/SBVR5)	Vacuum suction (DK812SALR/SAFLR/SBLR/SBFLR/SALR5/SAFLR5/SBLR5/SBFLR5)	
Number of strokes ¹	60 million			
Protection grade ²	Straight model: IP66, right-angle model: IP64 (IP67 ³)			
Vibration resistance	20 to 2000 Hz 100 m/s ²			
Impact resistance	1000 m/s ² 11 ms			
Operating temperature	0 to 50 °C			
Storage temperature	-20 to 60 °C			
Power supply	5 VDC±5 %			
Power consumption	1 W			
Mass ⁴	Approx. 30 g			
Output cable length	2.4 m			
Feeler	Carbide ball tip, Mounting screw M2.5		Steel ball tip, Mounting screw M2.5	
Accessories	Instruction Manual, +P M4 x 5 screw (2pc), tightening nut, clamp spanner, wave washer, mounting pin 1 each (DK8**S**F** only) Hose elbow 1 pc (DK8**S**L** only), one spanner			

¹ Under specific test conditions defined by Magnescale Co., Ltd. Pneumatic push Model: 30 million time ² Excluding the interpolation box and connector
³ When φ4 mm tube is connected for right-angle model ⁴ Excluding cable section and interpolation box

DK812SAFR/DK812SAFR5
DK812SBFR/DK812SBFR5

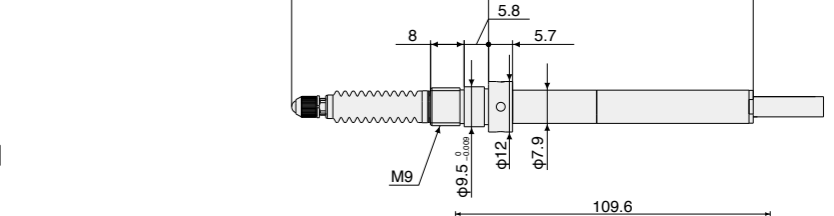

DK812SAFLR/DK812SAFLR5
DK812SBFLR/DK812SBFLR5

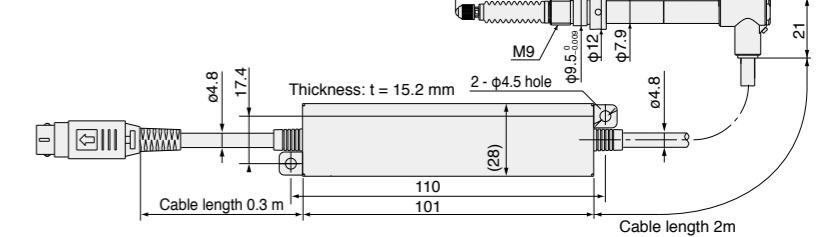

DK812SAVR/DK812SAVR5
DK812SBVR/DK812SBVR5
(Pneumatic push model)

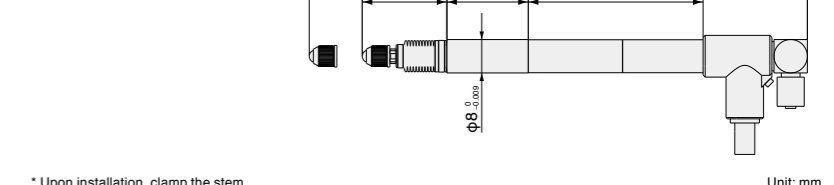

* Upon installation, clamp the stem.

Unit: mm

DK DK830S

Resolution **0.1 μm** Stem **φ8** Stroke **30mm** Output **A/B phase**

DK830SR

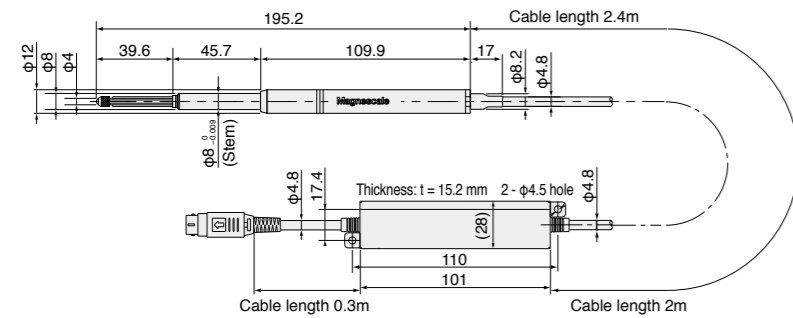

* Upon installation, clamp the stem.

DK830SLR

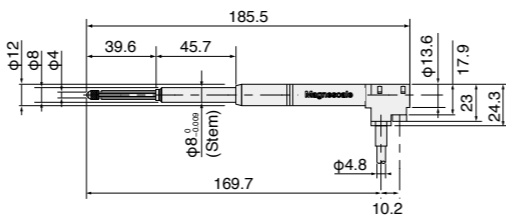

* Upon installation, clamp the stem.

DK830SVR

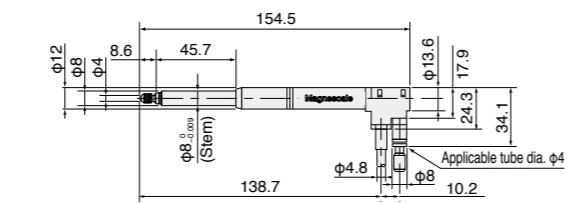

* Upon installation, clamp the stem.

Unit: mm

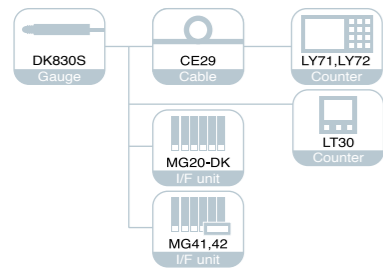

Model	Straight model		Right angle model		Pneumatic push type	
	DK830SR		DK830SLR		DK830SVR	
Measuring range	30 mm					
Maximum resolution	0.1 μm (0.5 μm resolution can also be selectable as special specifications.)					
Accuracy (at 20°C/68°F)	1.3 μm				1.7 μm	
Measuring force (at 20°C/68°F)	Upward: 0.5±0.35 N Horizontal: 0.6±0.35 N Downward: 0.7±0.35 N		Upward: 0.5±0.35 N Horizontal: 0.6±0.35 N Downward: 0.7±0.35 N		Upward: 0.5±0.35 N Horizontal: 0.6±0.35 N Downward: 0.7±0.35 N	
Maximum response speed	80 m/min					
Reference point	Position at spindle movement of 1mm					
Reference-point response speed	Same as the noted maximum response speed					
Output	A/B/reference point Voltage-differential line driver output (conforming to EIA-422)					
Spindle drive system	Spring push				Pneumatic push	
Achieved number of strokes ¹	60 million				30 million	
Protection grade ²	IP53		IP53/IP67 ³			
Vibration resistance	20 to 2000 Hz 100 m/s ²					
Impact resistance	1000 m/s ² 11 ms					
Operating temperature	0 °C to 50 °C					
Storage temperature	-20 °C to 60 °C					
Power supply	5 VDC±5 %					
Power consumption	1 W					
Mass ⁴	Approx. 70 g		1 W		Approx. 80 g	
Output cable length	2.4 m					
Feeler	Carbide ball tip, Mounting screw M2.5					
Accessories	Instruction Manual, +P M4 × 5 screw (2pc)					

¹ Under specific test conditions defined by Magnescale Co., Ltd. ² Excluding the interpolation box and connector
³ When the bellows set (optional accuracy) is mounted ⁴ Excluding cable section and interpolation box

DK DK10/25

Resolution **0.5 μm** Stem **φ20** Stroke **10mm** Stroke **25mm** Output **A/B phase**

DK10NR5/PR5

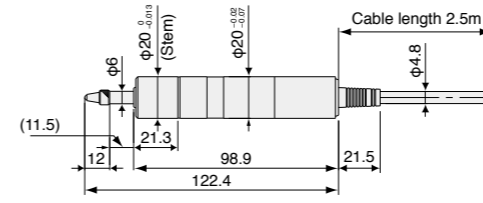

* Upon installation, clamp the stem.

DK25NR5/PR5

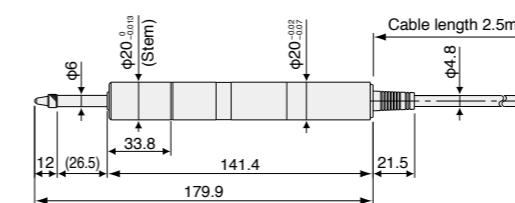

* Upon installation, clamp the stem.

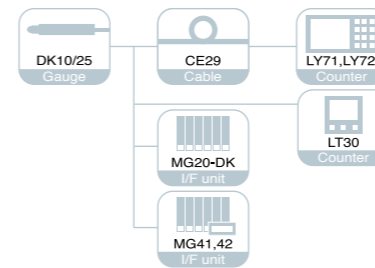

Model	Protected type model			Protected type model			Protected type model	
	DK10NR5	DK10PR5	DK10PLR5	DK25NR5	DK25PR5	DK25NLR5	DK25PLR5	
Measuring range	10 mm						25 mm	
Maximum resolution	0.5 μm							
Accuracy (at 20°C/68°F)	2 μm							
Measuring force (at 20°C/68°F)	Upward: 0.3±0.25 N Horizontal: 0.6±0.3 N Downward: 0.8±0.35 N		4.9 N or less		Upward: 0.4±0.3 N Horizontal: 0.7±0.35 N Downward: 1±0.4 N		4.9 N or less	
Maximum response speed	250 m/min							
Reference point	Position at spindle movement of 1mm							
Reference-point response speed	Same as the noted maximum response speed							
Output	A/B/reference point Voltage-differential line driver output (conforming to EIA-422)							
Spindle drive system	Spring push							
Protection grade ¹	IP50		IP64		IP50		IP64	
Vibration resistance	10 to 2000 Hz 150 m/s ²							
Impact resistance	1500 m/s ² 11 ms							
Operating temperature	0 to 50 °C							
Storage temperature	-20 to 60 °C							
Power supply	5 VDC±5 %							
Power consumption	1 W							
Mass ²	Approx. 230 g				Approx. 300 g			
Output cable length	2.4 m							
Feeler	Carbide ball tip, Mounting screw M2.5							
Accessories	Instruction Manual, +P M4 × 5 screw (2pc)							

¹ Excluding the interpolation box and connector
² Excluding cable section and interpolation box

* DK50NR5/PR5



DK10PLR5

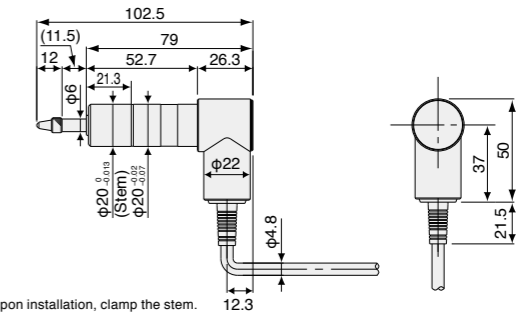

* Upon installation, clamp the stem.

DK25NLR5/PLR5

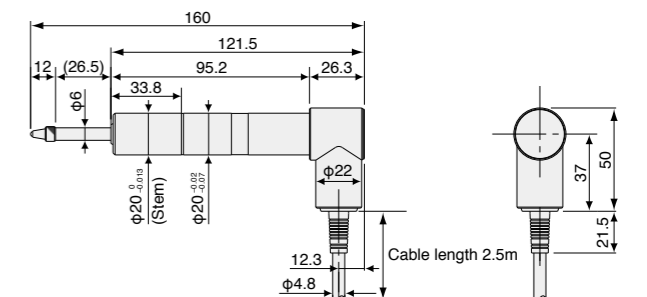

* Upon installation, clamp the stem.

Unit: mm

DK DK50/100

Resolution **0.5 μm** Stem **φ20** Stroke **50mm** Stroke **100mm** Output **A/B phase**



* DK50NR5/PR5

DK50NR5/PR5

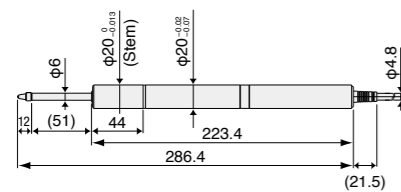

* Upon installation, clamp the stem.

DK100NR5/PR5

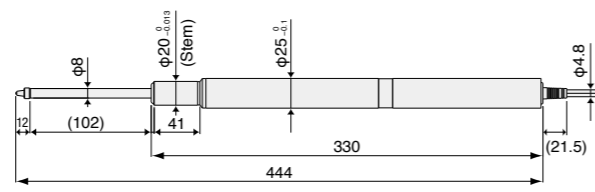

* Upon installation, clamp the stem.

Unit: mm

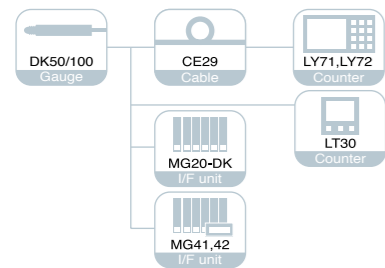

Specifications

Model	Standard model		Protected type model	
	DK50NR5	DK50PR5	DK100NR5	DK100PR5
Measuring range	50 mm		100 mm	
Maximum resolution	0.5 μm			
Accuracy (at 20°C/68°F)	2 μm		4 μm	
Measuring force (at 20°C/68°F)	Upward: - Horizontal: 0.9±0.4 N Downward: 1.3±0.5 N	6.2 N or less	Upward: - Horizontal: 1.8±0.65 N Downward: 2.7±0.55 N	9.3 N or less
Maximum response speed	250 m/min			
Reference point	Position at spindle movement of 1 mm			
Reference-point response speed	Same as the noted maximum response speed			
Output	A/B/reference point Voltage-differential line driver output (conforming to EIA-422)			
Spindle drive system	Spring push			
Protection grade ¹	IP50	IP64	IP50	IP64
Vibration resistance	10 to 2000 Hz 150 m/s ²			
Impact resistance	1500 m/s ² 11 ms			
Operating temperature	0 to 50 °C			
Storage temperature	-20 to 60 °C			
Power supply	5 VDC±5 %			
Power consumption	1 W			
Mass ²	Approx. 360 g		Approx. 630 g	
Output cable length	2.4 m			
Feeler	Carbide ball tip, Mounting screw M2.5			
Accessories	Instruction Manual, +P M4 × 5 screw (2pc)			

¹ Excluding the interpolation box and connector
² Excluding cable section and interpolation box

DK DK155/205

Resolution **0.5 μm** Stem **φ32** Stroke **155mm** Stroke **205mm** Output **A/B phase**



* DK155PR5

DK155PR5

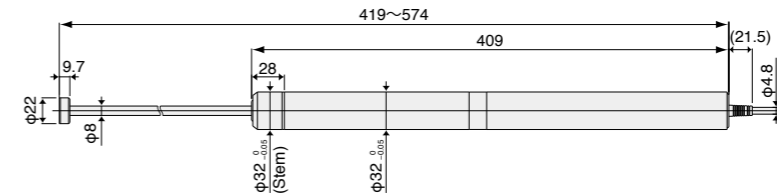

* Upon installation, clamp the stem.

DK205PR5

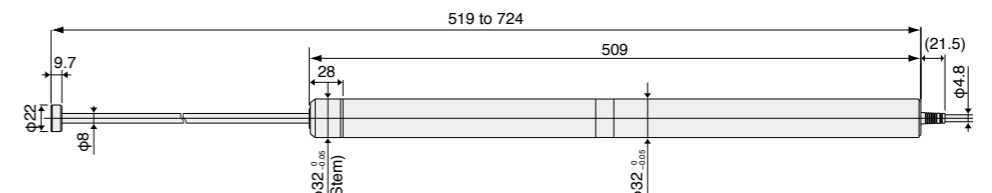

* Upon installation, clamp the stem.

Unit: mm

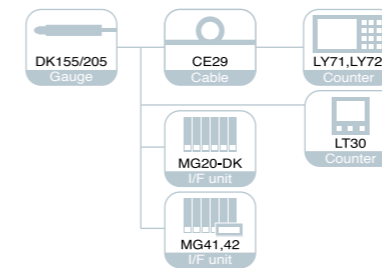

Specifications

Model	DK155PR5	DK205PR5
Measuring range	155 mm	205 mm
Maximum resolution	0.5 μm	
Accuracy (at 20°C/68°F)	5 μm	6 μm
Maximum response speed	250 m/min	
Reference point	Position at spindle movement of 5 mm	
Reference-point response speed	Same as the noted maximum response speed	
Output	A/B/reference point Voltage-differential line driver output (conforming to EIA-422)	
Spindle drive system	None	
Protection grade ¹	IP64	
Vibration resistance	10 to 2000 Hz 150 m/s ²	
Impact resistance	1500 m/s ² 11 ms	
Operating temperature	0 to 50 °C	
Storage temperature	-20 to 60 °C	
Power supply	5 VDC±5 %	
Power consumption	1 W	
Mass ²	Approx. 1100 g	Approx. 1300 g
Output cable length	2.4 m	
Surface to be measured	Soft magnetic material	
Magnetically attachable feeler	Magnetic attraction: 10 N, resistance against horizontal slip: 2.7 N, Provided with a φ4 mm carbide ball tip	
Spindle ³	φ8 mm, radial swing: 0.04 mm max.	
Accessories	Instruction Manual, +P M4 × 5 screw (2pc)	

¹ Excluding the interpolation box and connector
² Excluding cable section and interpolation box
³ The spindle weighs about 400 g.

DK DK110

Resolution **0.5μm** Stem **φ20** Stroke **110mm** Output **A/B phase**

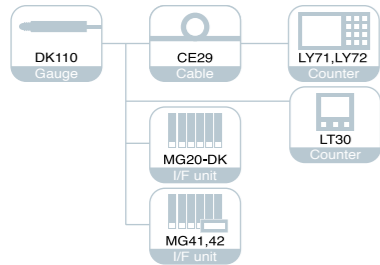
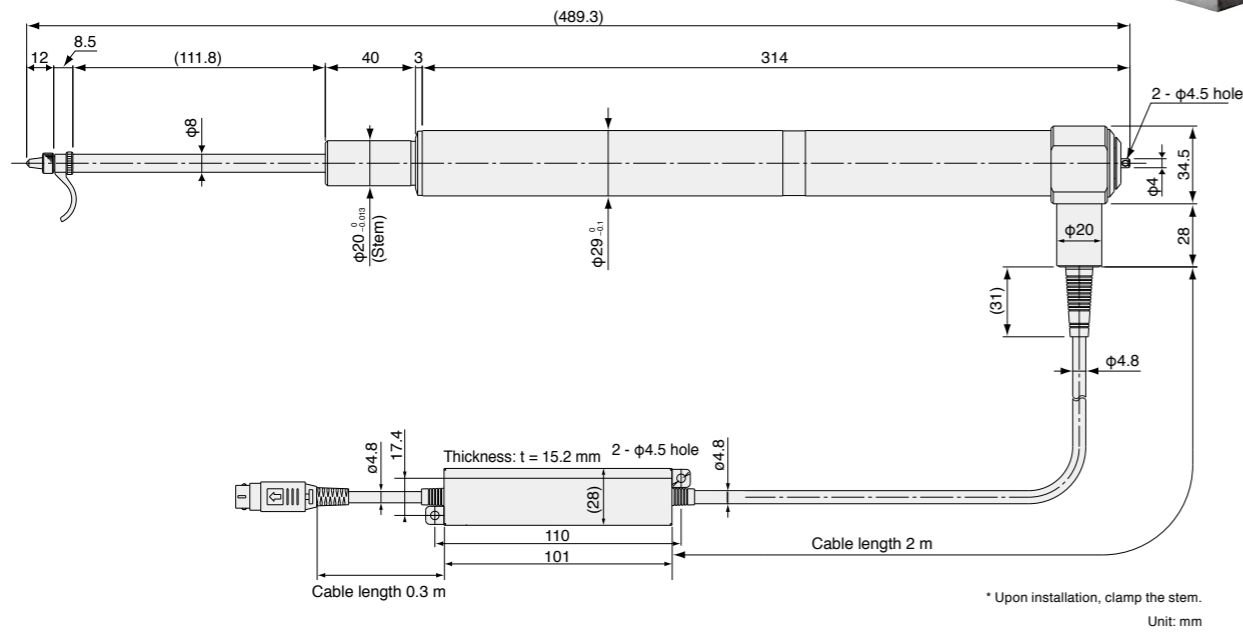
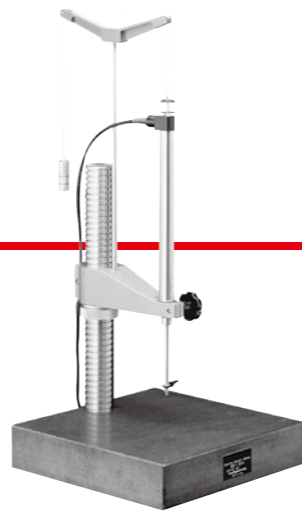

Specifications	
Model	DK110NLR5
Measuring range	110 mm
Maximum resolution	0.5 μm
Accuracy (at 20°C/68°F)	4 μm
Maximum response speed	250 m/min
Reference point	Position at spindle movement of 5 mm
Reference-point response speed	Same as the noted maximum response speed
Output	A/B/reference point Voltage-differential line driver output (conforming to EIA-422)
Spindle drive system	Spring push
Protection grade ¹⁾	IP50
Vibration resistance	10 to 2000 Hz 150 m/s ²
Impact resistance	1500 m/s ² 11 ms
Operating temperature	0 to 50 °C
Storage temperature	-20 to 60 °C
Power supply	5 VDC±5 %
Power consumption	1 W
Mass ²⁾	Approx. 800 g
Output cable length	2.4 m
Feeler	Carbide ball tip, Mounting screw M2.5
Accessories	Instruction Manual, +P M4 × 5 screw (2pc), Lift lever DZ-161

¹⁾ Excluding the interpolation box and connector

²⁾ Excluding cable section and interpolation box

DK Series measuring unit output signals

The signal output from these measuring units are A/B/Z reference point, voltage differential line driver (compliant with EIA-422) output compliant with EIA-422.

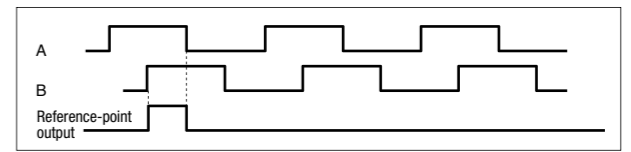

The reference point is synchronized with A and B phases at high impedance. (Note: this may not be worded correctly)

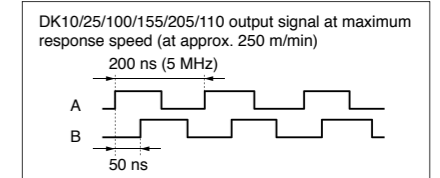
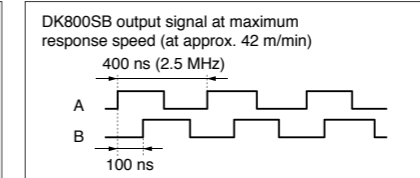
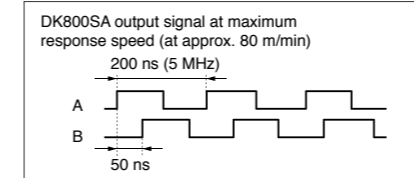

The A/B quadrature output signal by measuring unit is 5 MHz maximum with a minimum phase difference of 50 ns for DK800SA and is 2.5 MHz maximum with a minimum phase difference of 100 ns for DK800SB.

The counter or control device capable of processing these signals should be used.

For DK the A/B quadrature output signal by measuring unit is 5 MHz maximum with a minimum phase difference of 50 ns.

The counter or control device capable of processing these signals should be used.

Output Signal Phase Difference

Moving length of the measuring unit is detected every 50 ns for the DK800SA/DK and every 100 ns for the DK800SB, and the phase difference proportional to the amount traveled is output.

The amount of phase difference changes in integer multiples of 50 ns or 100 ns.

Also, the minimum phase difference for the phase A and B is 50 ns for the DK800SA/DK and 100 ns for the DK800SB.

In the standard specifications, the minimum phase difference is fixed at 50 ns for the DK800SA and 100 ns for the DK800SB, however, the minimum phase differences in the following table below are available as special specifications.

Phase A/B Minimum phase difference	Phase A single cycle	Counter's permissible frequency	Maximum response speed		Remarks
			Resolution 0.1 μm	Resolution 0.5 μm	
50ns	200ns	5MHz	80m/min	250m/min	DK800SA standard product
100ns	400ns	2.5MHz	42m/min	100m/min	DK800SB standard product
300ns	1.2μs	833kHz	14m/min	33m/min	Special specifications
500ns	2μs	500kHz	8.4m/min	20m/min	Special specifications

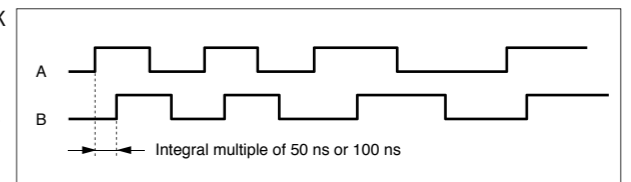

Output Signal Alarm

If the response speed is exceeded, the phase A/B output from this measuring unit changes to high impedance state for about 400 ms as an alarm.

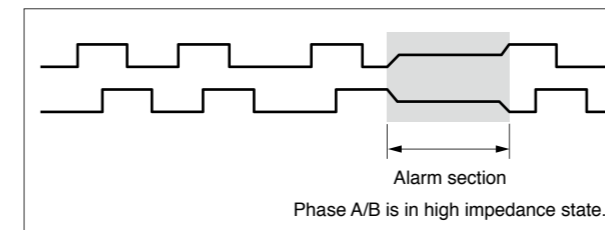

Receiver

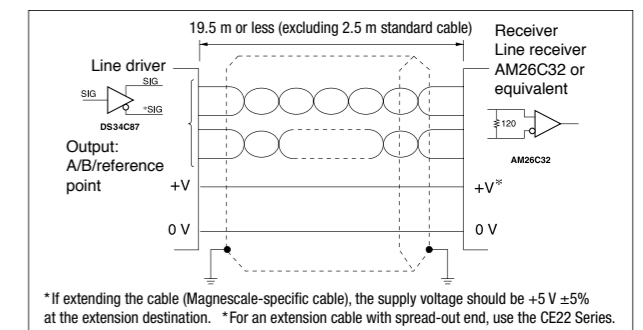

*If extending the cable (Magnescale-specific cable), the supply voltage should be +5 V ±5% at the extension destination. *For an extension cable with spread-out end, use the CE22 Series.

DK Series operating cautions

- For the pneumatic push type, use of the pneumatic circuit shown in Fig. 1 enables the feeler to be air driven. Pressure regulation is required depending on the usage condition. A precision pressure regulator (e.g., SMC IR2010 or equivalent) should be used.
- For the vacuum suction type, use of the pneumatic circuit shown in Fig. 2 enables the feeler to be air driven.

Fig. 1 Pneumatic circuit (pneumatic push)

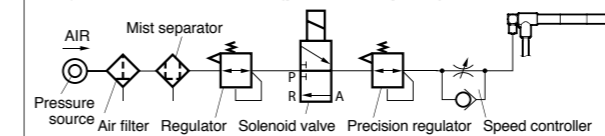
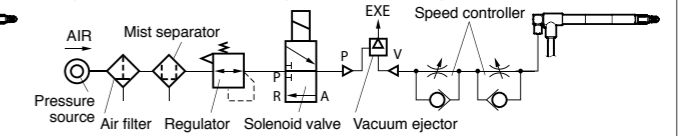
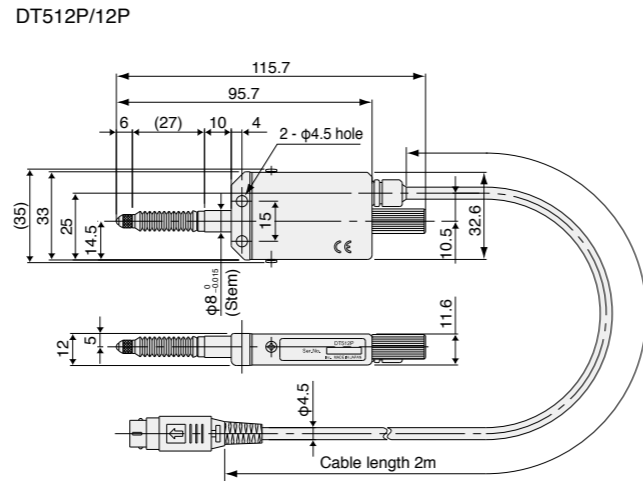
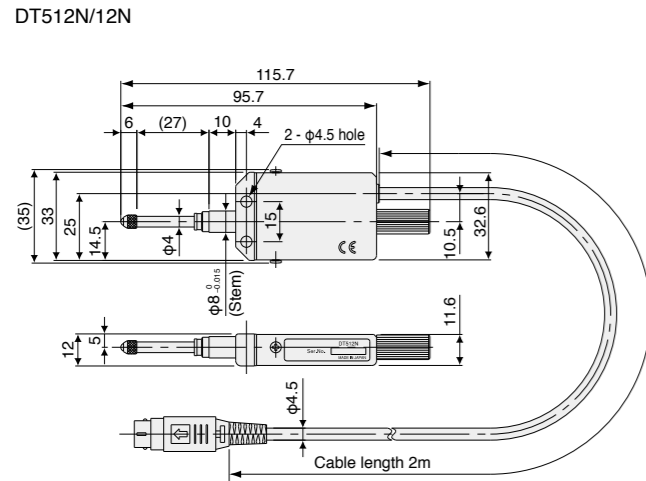
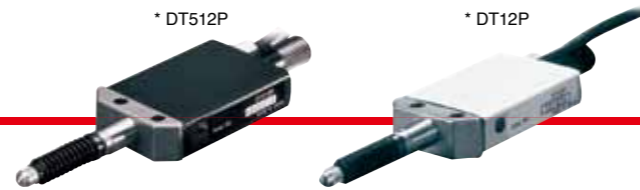

Fig. 2 Pneumatic circuit (vacuum suction)



DT DT512/12

Resolution **1 μm**
Resolution **5 μm**
Stem **φ8**
Stroke **12mm**



* Upon installation, clamp the stem.

* Upon installation, clamp the stem.

Unit: mm

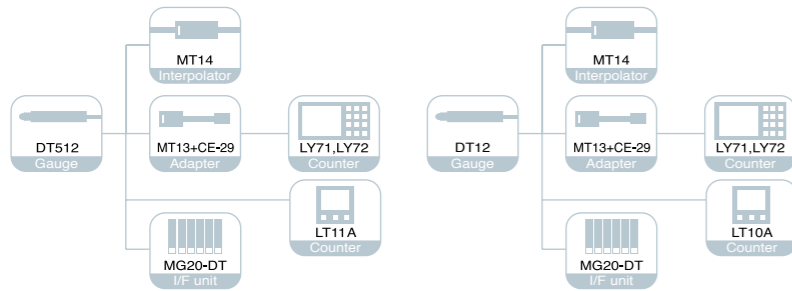

Specifications	Standard model		Protected type model	
	DT512N	DT512P	DT12N	DT12P
Model	DT512N	DT512P	DT12N	DT12P
Measuring range	12 mm			
Maximum resolution	1 μm		5 μm	
Accuracy (at 20°C/68°F)	6 μm		10 μm	
Measuring force (at 20°C/68°F)	Upward: 0.7±0.5 N Horizontal: 0.8±0.5 N Downward: 0.9±0.5 N	1.7 N or less in all directions	Upward: 0.7±0.5 N Horizontal: 0.8±0.5 N Downward: 0.9±0.5 N	1.7 N or less in all directions
Maximum response speed	Depending on unit to be connected			
Reference point	None			
Spindle drive system	Spring push-out			
Achieved number of strokes ¹	5 million			
Protection grade ²	—	IP64 or equivalent	—	IP64 or equivalent
Operating temperature	0 to 50 °C			
Storage temperature	-10 to 60 °C			
Mass ³	Approx. 75 g	Approx. 80 g	Approx. 75 g	Approx. 80 g
Output cable length	2 m			
Feeler	Steel ball tip, Mounting screw M2.5			
Accessories	Instruction Manual			

¹ Under specific test conditions defined by Magnescale Co., Ltd.

² Excluding the connector

³ Excluding cable section

DT DT32

Resolution **5 μm**
Stem **φ8**
Stroke **32mm**

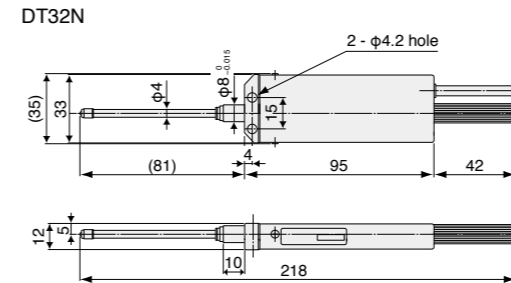
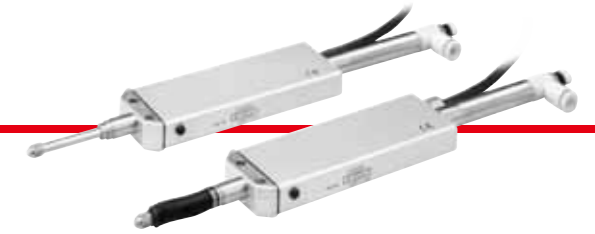

* Upon installation, clamp the stem.

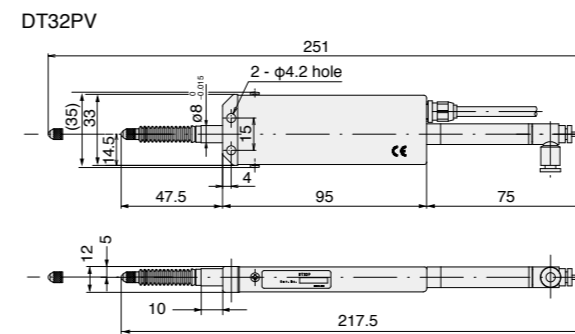

* Upon installation, clamp the stem.

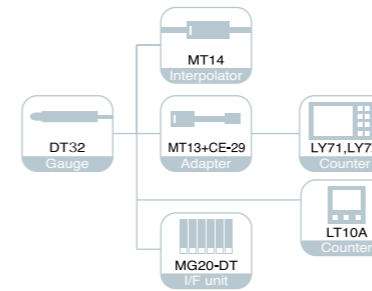

Specifications	Standard model		Protected type model	
	DT32N	DT32NV	DT32P	DT32PV
Model	DT32N	DT32NV	DT32P	DT32PV
Measuring range	32 mm			
Maximum resolution	5 μm			
Accuracy (at 20°C/68°F)	10 μm			
Measuring force (at 20°C/68°F)	¹ Upward: 1.1±0.8 N Horizontal: 1.3±0.8 N Downward: 1.5±0.8 N		2.9 N or less in all directions	² 9 N in all directions
Maximum response speed	Depending on unit to be connected			
Reference point	None			
Spindle drive system	Spring push-out	Pneumatic push	Spring push-out	Pneumatic push
Achieved number of strokes ³	5 million			
Protection grade ⁴	—		IP64 or equivalent	
Operating temperature	0 to 50 °C			
Storage temperature	-10 to 60 °C			
Mass ⁵	Approx. 120 g	Approx. 140 g	Approx. 120 g	Approx. 140 g
Output cable length	2 m			
Feeler	Provided with a steel ball tip, Mounting screw M2.5			
Accessories	Instruction Manual			

¹ At input air pressure of 1.96 × 10⁵ Pa with speed controller open (DT32N) ² At input air pressure of 2.35 × 10⁵ Pa with speed controller open

³ Based on the Magnescale-specified evaluation method ⁴ Excluding the connector ⁵ Excluding cable section

MT MT12/13/14

U U Series

Output A/B phase

MT12/13

Measuring unit connector

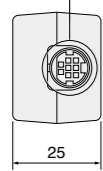

MT14

Counter connector

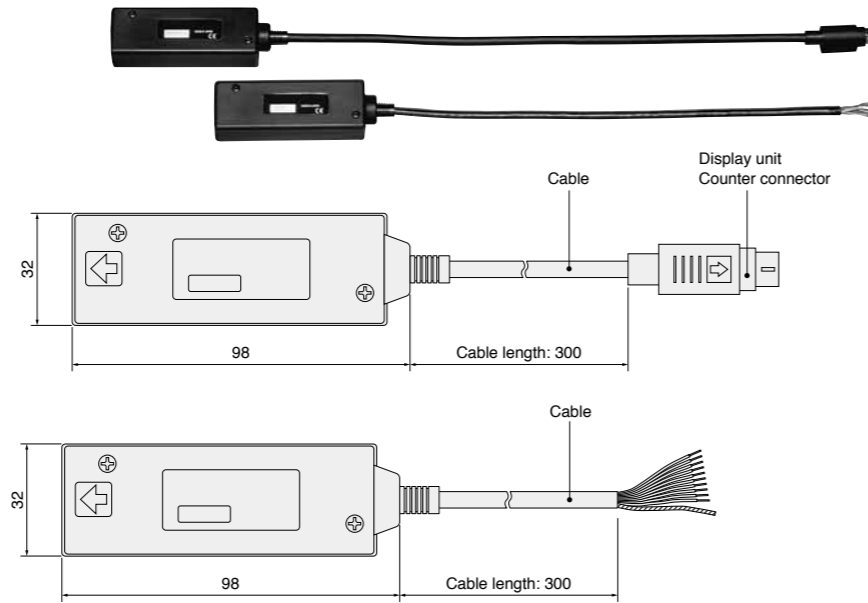
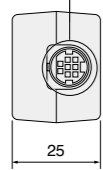

Unit: mm

* Connection of the DT Series enables A/B phase output.

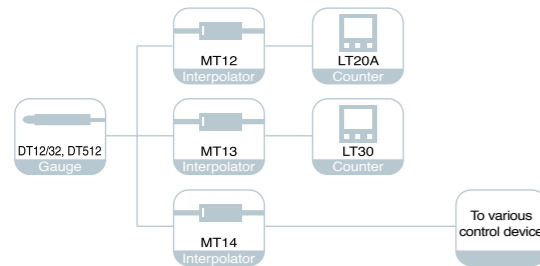

Phase difference for phase A/B output

Model	MT□□-01	MT□□-05	MT□□-10	Output phase difference (μs)
Velocity: v (m/min)	0 < v ≤ 2.5	0 < v ≤ 12.5	0 < v ≤ 25	20
	2.5 < v ≤ 6.25	12.5 < v ≤ 31.25	25 < v ≤ 62.5	8
	6.25 < v ≤ 12	31.25 < v ≤ 60	62.5 < v ≤ (100)*	5
	12 < v ≤ 24	60 < v ≤ (100)*	—	2.5
	24 < v ≤ 60	—	—	1
	60 < v ≤ (100)*	—	—	0.5

* An alarm is output at a traveling velocity of 100 to 115 m/min. The sampling frequency of the output signal is 120 μs.

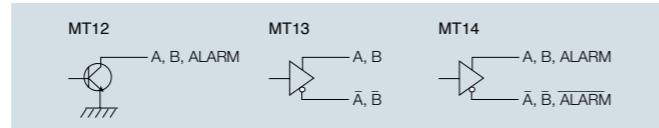

Cable color MT12

Output signal: Phase A/B
Alarm output format: NPN open collector output (max. rated voltage: 31 V, max. rated current: 50 mA)

Pin no.	Description	Cable color
1	+5 V	Red
2	—	—
3	0 V	Black
4	A	Yellow
5	B	Blue
6	—	—
7	—	—
8	ALARM	Gray
9	0 V	Purple
10	0 V	Orange
Case	FG	Shield

Cable color MT13

Output signal: Phase A/B (The output becomes High impedance during an alarm.)
Output format: Voltage-differential line driver output (compliant with EIA-422)

Pin no.	Description	Cable color
1	+5 V	Purple
2	0 V	Black
3	A	Blue
4	A̅	Yellow
5	B	Orange
6	B̅	Gray
7	—	—
8	—	—
Case	FG	Shield

* Connector used: Hosiden TCP6182 or equivalent product 0 V and the shield (FG) are connected via a capacitor. Nothing should be connected to cables with colors not found in this table.

Cable color MT14

Output signal: A/B phase, alarm (The output does not become High impedance during an alarm.)
Output format: Voltage-differential line driver output (compliant with EIA-422)

Description	Cable color
+5 V	Red
0 V	White
0 V	Brown
0 V	Black
A	Yellow
A̅	Blue
B	Gray
B̅	Orange
ALARM	Purple
ALARM	Green
FG	Shield

* 0 V and the shield (FG) are connected with a capacitor.

Specifications

Model	MT12-05	MT12-10	MT13-01	MT13-05	MT13-10	MT14-01	MT14-05	MT14-10
Compatible measuring units	DT512, DT12/DT32							
Maximum response speed	100 m/min							
Resolution	5 μm	10 μm	1 μm	5 μm	10 μm	1 μm	5 μm	10 μm
Power voltage	5 VDC±5 %							
Power consumption	0.9 W		1.2 W (when output load of 120Ω is connected)					
Output format	Open collector		A/B Voltage-differential line driver					
Operating temperature and humidity range	0 to 50 °C (No condensation)							
Storage temperature and humidity range	-10 to 60 °C (20 to 90 %RH)							
Mass	Approx. 90 g							

Resolution 1μm Stem φ8 Stroke 12mm Stroke 30mm Stroke 60mm Output RS-232C

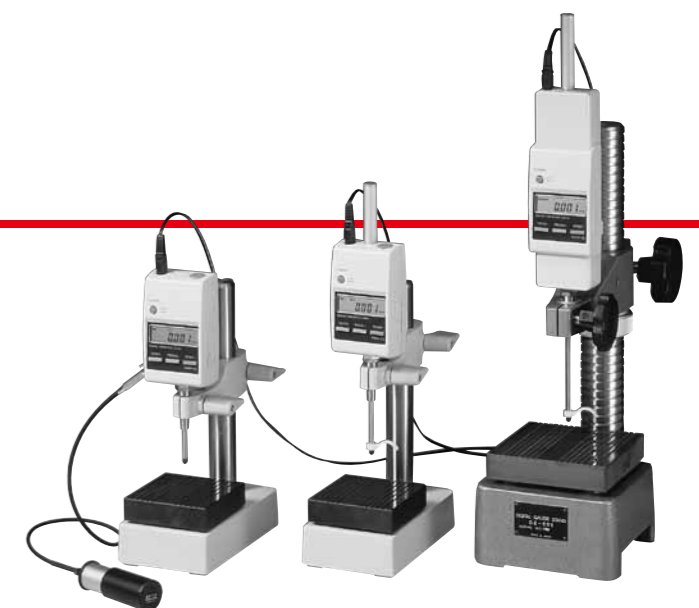

* Set bushing DZ-811 (optional) is required to use U60B with gauging stand DZ-501.
* The air release and the gauging stand are optional accessories.

U12B

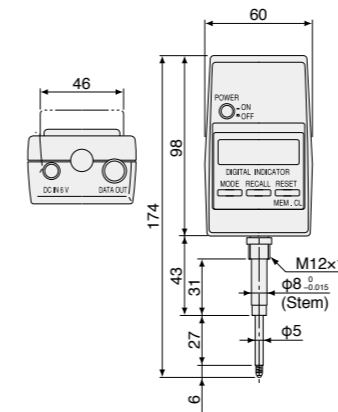

U30B

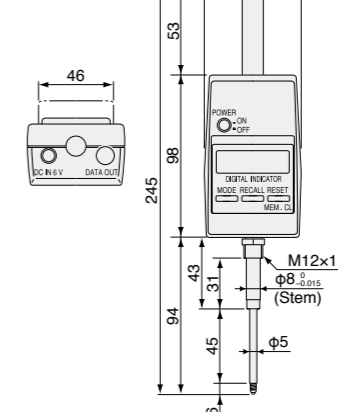

U60B

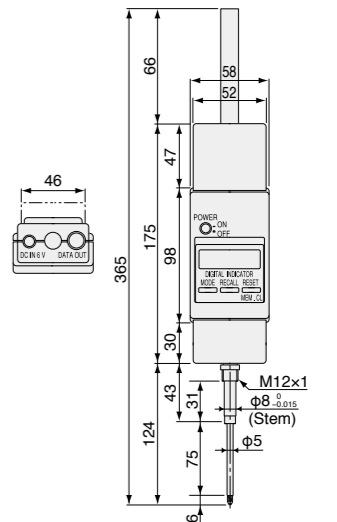

Unit: mm

Specifications

Model	U12B	U30B	U60B
Measuring range	12 mm	30 mm	60 mm
Maximum resolution	1 μm		
Accuracy (at 20°C/68°F)	2 μm		
Measuring force (at 20°C/68°F)	1.3 N or less	1.5 N or less	2.2 N or less
Travel length of the release	Full stroke		
Display	LCD display element (6 digits, minus display)		
Maximum response speed	0.4 m/s (24 m/min)		
Operating temperature	0 to 40°C (no condensation)		
Storage temperature	-10 to 50°C (no condensation)		
Power supply	6 VDC±10 % (With DC IN jack) 6 to 9 VDC±10 % (With data connector used)		
Power consumption	1 W		
Mass	Approx. 190 g	Approx. 230 g	Approx. 300 g
Feeler	Carbide ball tip, Mounting screw M2.5		
Accessories	Instruction Manual, AC adapter available (We DO NOT provide an AC adaptor with these.), lift lever, and dedicated spanner		

DKS

DK

DT(MT)

U

MG

LT

LV

DKS

DK

DT(MT)

U

MG

LT

LV

Installation

DK812S installation cautions

Feeler installation/removal method

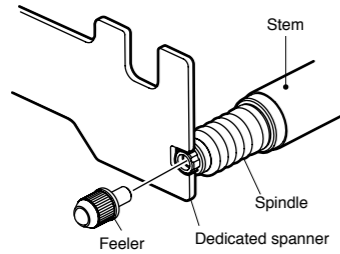

Mounting holder dimensions and tolerance

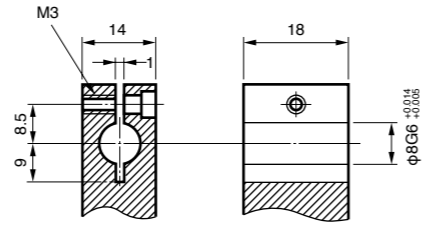

Tightening torque: 0.6 N·m
Material: In case of SUS303

Unit: mm

DK812SF installation cautions

Feeler installation/removal method

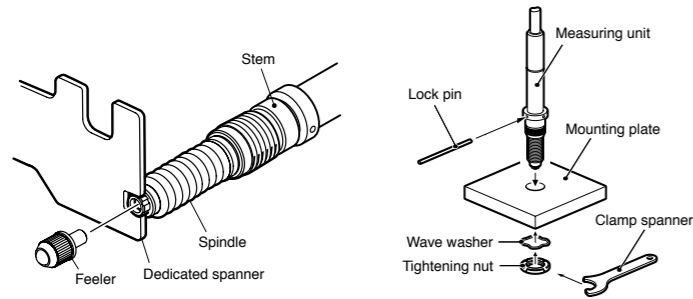

- The recommended value of measuring unit mounting hole is $\phi 9.7 \pm 0.15$ mm.
- The mounting thickness is as follows:
DK812SF Series: 7 to 11 mm
DK805SF Series: 9 to 11 mm
- Mounting parallelism affects measurement accuracy.
- Adjust the squareness to the surface to be measured or parallelism with respect to traveling to 0.02 mm/14 mm or less.

DK830 installation cautions

Feeler installation/removal method

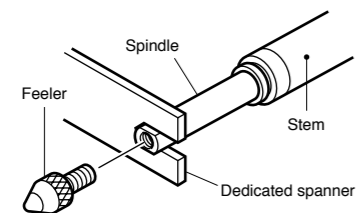

Mounting holder dimensions and tolerance

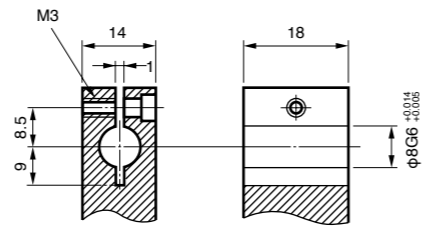

Tightening torque: 0.6 N·m
Material: In case of SUS303

Unit: mm

DK10/25 installation cautions

Mounting/fixing position

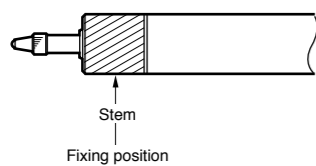

Mounting holder configuration dimensions (for reference)

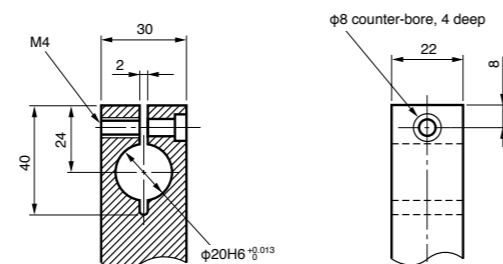

Tightening torque: 4 N·m
Hex. socket head bolt M4 is used.

Unit: mm

DK50/100 installation cautions

Mounting/fixing position

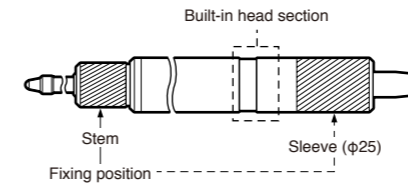

Mounting holder configuration dimensions (for reference)

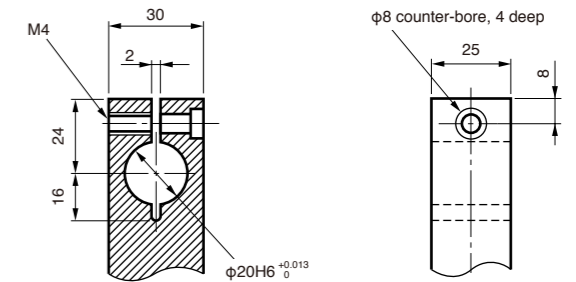

Tightening torque: 4 N·m
Hex. socket head bolt M4 is used.

Unit: mm

DK155/DK205 installation cautions

Mounting/fixing position

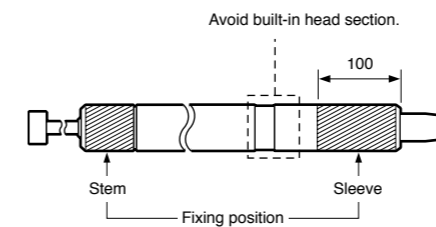

Mounting holder configuration dimensions (for reference)

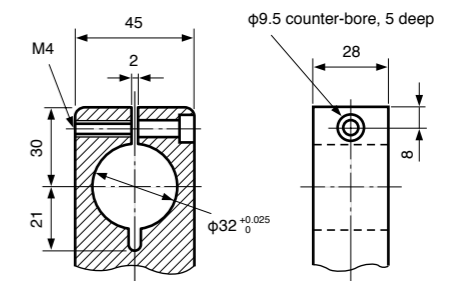

Tightening torque: 6 N·m
Hex. socket head bolt M5 is used.

Unit: mm

DT12/512/32 installation cautions

Mounting method using mounting hole

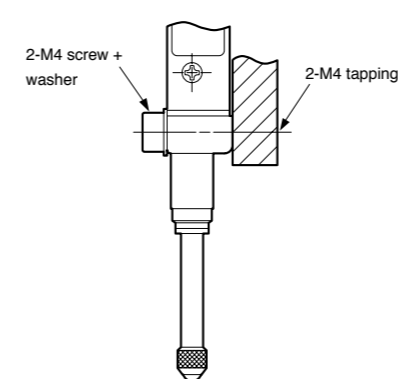

Mounting method using holder

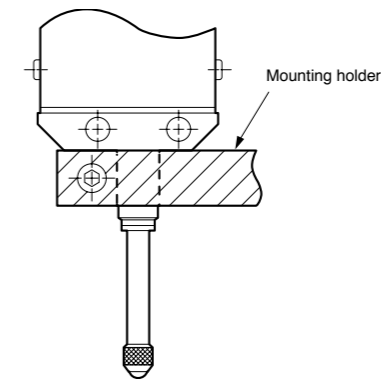

Mounting holder dimensions and tolerance

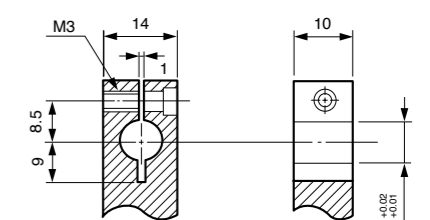

Tightening torque: 0.18 to 0.23 N·m
Material: In case of S45C

Unit: mm

Interface unit

MG40 Series

28

MG10/20/30

29

MG40 Series



Main unit
MG41-NC
(for CC-Link, Ethernet)

Main unit
MG41-NE
(for Ethernet)

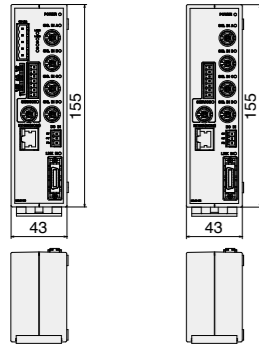

Hub unit
MG42

* Common to MG41-NC and MG41-NE

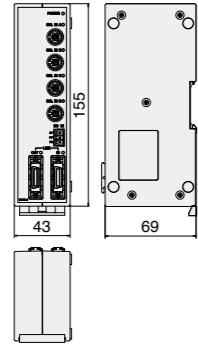

Display unit
MG43

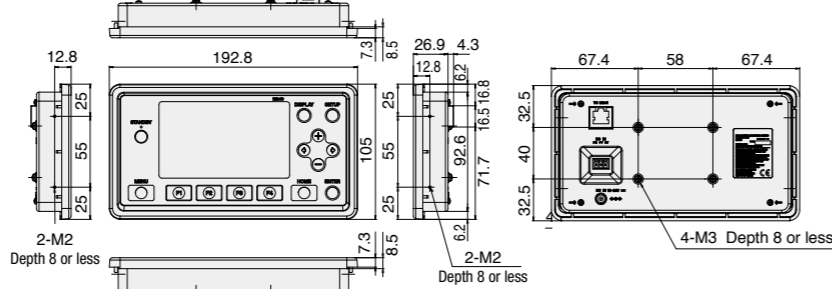

Link cable MZ41-R5(0.5 m), MZ41-R01(1 m), MZ41-R5(5 m) MZ41-10(10 m)

Unit: mm

Specifications			
Item	Conditions, etc.	Description	Remarks
Communication method		MG41-NC (CC-Link/Ethernet incorporated) / MG41-NE (Ethernet incorporated) / MG42-4 (hub unit)	
No. of connectable measuring units	Entire system MG41 main unit MG42 hub unit	1 to 100 units (Connection of 101th unit and later disabled) 0 to 4 units	Up to 24 connected MG42 hub units
Connectable measuring units		DK800S, DK830S, DK800A/DK800B Series, DK10, DK25, DK50, DK100, DK110, DK155, DK205	
Connection cable length		MG41 main unit to MG42 hub unit, MG42 total cable length to MG42 hub unit: 0.5 m, 1 m, 2 m, 5 m, 10 m Total cable length from MG41 main unit: 30 m max. (Max. current: 4 A or less)	Connection cable MZ41-1** (optional)
Resolution		Settable output data resolution and display resolution	
Measuring unit resolution (Input resolution)	0.1 μm 0.5 μm	0.1 μm 0.5 μm 1 μm 5 μm 10 μm	
Measuring unit data fetching capacity	10 Mbps data transfer	Maximum 10,000 data/sec (when 100 axes are connected)	Data for one axis is counted as one data.
Peak-hold function		Calculation of maximum, minimum, and peak-to-peak values for each axis (including pause, latch, and start functions) Peak value is not updated during pause. No output and display data updated during latching (but internal data is updated). Recalculation of peak value is started by start function.	
Output-enable data	Single axis At addition and subtraction	Current, maximum, minimum, and peak-to-peak values for each axis Current, maximum, minimum, and peak-to-peak values of addition and subtraction axes of two axes	Single-axis calculation of addition and subtraction axes is disabled.
Comparator function		Data of each axis (single axis, addition/subtraction axis) is compared and measured to output the comparator results (Comparator is also latched during latch)	
Comparator setting values	2 values 4 values 8 values 16 values	4 values 8 values 16 values 16 groups	
Ethernet		100Base-T (compliant with IEEE 802.3) 100 Mbps/10 Mbps (Auto-negotiation) Command input, data output, and parameter setting enabled.	
Reset function		The Current value for each axis is reset (with command).	
Pre-set function		The Value is preset to the current value of each axis (with command).	
Datum-point setting function		The Datum point of each axis is settable (with command).	When master calibration function is not used
Reference point function		The datum point of each axis can be reproduced using the reference point (with command).	
Master calibration function		Master calibration of each axis can be reproduced using the reference point (with command).	Addition and subtraction axes are unavailable.
Measuring unit product information		The product information of the connected measuring unit can be acquired (with command). Product code, serial no., production date	
Command/setting enabled or disabled for each communication line	Command	Reset function	Ethernet CC-Link
		Pre-set function	○ ○
		Datum-point setting function	○ ○
		Reference point function	○ ○
		Master calibration function	○ ○
		Comparator value setting	○ ○
		Comparator group number setting	○ ○
		Start	○ ○
		Pause	○ ○
		Latch	○ ○
		Current value/Peak value (All axes)	○ ○
		Current value/Peak value (each unit)	○ ○
		Comparator judgment result	○ ○
		Alarm (Communication/Measuring unit)	○ ○
		Software version	○ ○
Data output	Measuring unit product information	○ ○	
	Input resolution	○ ○	
	Display and output resolution	○ ○	
	Axis addition	○ ○	
	Comparator mode (2, 4, 8, or 16 values in 1 group)	○ ○	
Supply voltage	Terminal board	12 to 24 V (11 to 26.4 V) DC System total: Max. current 4 A	Used by adding power at a current of 4A or more on a six MG42 hub units basis. (Recommended: +24 V)
Power consumption	Cautions for connecting conditions	If system power consumption exceeds the maximum current, supplying power to a succeeding MG42 hub unit enables the main unit to be connected to the succeeding MG42 hub unit. <Details of power consumption for each unit> MG41 main unit: 4 W, MG42 hub unit: 1 W/unit, Measuring unit supply: 1 W/unit	
Operating temperature and humidity range		0 to +50 °C (no condensation)	
Storage temperature and humidity range		-10 to +60 °C (20 to 90 % RH)	
Mass		MG41: 300 g MG42: 250 g	

* If DK800S connected to MG40 is connected to LT30 or MG10/20, the reference point cannot be recognized. For more information, contact our Sales Dept. in charge. * Connection of MG41 to MG43 using Ethernet connection requires an additional Ethernet hub.

Display unit MG43 specifications			
Item	Description	Item	Description
Compatible main units	MG41-NE/MG41-NC	Network interface	100Base-TX/10Base-T (compliant with IEEE802.3) Auto-negotiation
Compatible hub units	Hub units supported by the main unit	Power supply	12 to 14 V (11 to 26.4 V) DC
Compatible measuring units	Measuring units supported by the main unit and hub units	Power consumption	4 W
Main functions	Measured data monitoring, system monitoring, setting monitoring	Operating temperature & humidity range	0 to +40 °C (no condensation)
Communication protocol	Specific protocol on TCP/IP	Storage temperature & humidity range	-10 to +60 °C (20 to 90 % RH)
Screen display	480 x 272 pixels, 4.3-inch TFT LCD with backlight	Mass	Approx. 500 g

MG10/20/30



MG10-P1/P2

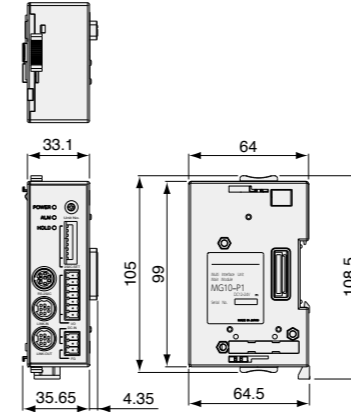

Unit: mm

MG20-DK/DT

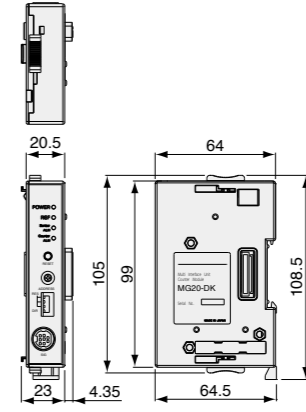

MG30-B1/B2

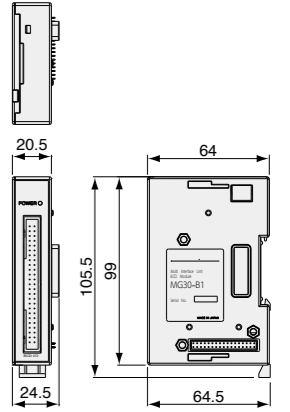

Main module specifications

Model	MG10-P1	MG10-P2
Power source	Power supply	12-24 V (11-26.4 V) DC, Min. startup time: 100ms or less
	Power consumption	2.0 W + total power consumption for connected modules ¹
	Inrush current (10 ms)	10 A or less (when maximum number of modules are connected)
Communication	Power supply protection	Fuse (5-A fuse is built in.)
	Communication I/F	RS-232C (EIA-232C or equivalent)
	Baud rate setting	2400 / 9600 / 19200 / 38400 bps (set with DIP switch)
	Data length	7 / 8 bit (set with DIP switch)
	Stop bit	1 / 2 bit (set with DIP switch)
Linkage function	Parity	None / ODD / EVEN (set with DIP switch)
	Delimiter	CR / CR+LF (set with DIP switch)
	Maximum number of linkages	16 (total of counter modules: 64)
I/O	Maximum length of linking cable	10 m
	Input format	Source input (+COM) Sink input (-COM)
Connectable modules	Output format	Photocoupler insulation, external power: 5-24 V DC Open collector output sink type (-COM) Source type (+COM)
	Input signal	Photocoupler insulation, external power: 5-24 V DC Reset, pause, start, latching, and data out trigger to whole channels
	Output signal	Integrated alarm
Counter modules	Counter modules	MG20-DK, MG20-DG, and MG-20DT (available for mixed use, up to 16 modules) ¹
	Interface modules	MG30-B1, MG30-B2 ¹

¹: Total power of modules connected to MG10 should not be over 54W (at 12 VDC input) or 108 W (at 24 VDC input).

Counter module specifications

Model	MG20-DK	MG20-DT
Power consumption	1 W + power consumption for connected gauge	0.8 W
Measuring unit input	Corresponding gauge	DK Series (Voltage differential A/B quadrature input) DT Series
	Allowable resolution setting ²	10/5/1/0.5/0.1 μm 5 μm (DT12/32) 1 μm (DT512)
	Maximum response speed	Subject to the specification of the connected gauge 1 m/s
	Maximum response acceleration	REF-LED (reference-point loaded) shows on the display after the reference point is detected. 2400m/s ²
Others	Reference point	Set "0" or preset value on the counter when the reference point is detected.
	Alarm	S-ALM LED activates by excess speed/acceleration of measuring unit. C-ALM LED activates by excess speed of the internal circuit of counter. The Alarm display is cancelled by reset command from MG10 or with the reset button of main unit.

²: Set the resolution value of the connected gauge.

Interface module specifications

Model	MG30-B1	MG30-B2
Power consumption	1 W	
I/O	Input format	Source type (+COM) Counterpart output circuit: current sink input (-COM) Current sink input (+COM) Counterpart output circuit: source type (+COM)
	Output format	Photocoupler insulation, external power: 5-24 V DC Current sink input (-COM) Counterpart output circuit: source type (+COM) Source type (+COM) Counterpart output circuit (+COM): source type (-COM)
	Input signal	Photocoupler insulation, external power: 5-24 V DC DRQ / channel address / measuring mode shifting / comparator shifting / reset / start / posing / reference-point loaded
	Output signal	BCD data (6 digits) / READY / code / Go/No-go output / alarm / reference-point
Output setting	Timer (1 to 128 ms) / OUT / OR / polarity (set with internal DIP switch)	
All models	Operating temperature	0 to +50 °C (No condensation)
	Storage temperature	-10 to +60 °C (20 to 90%RH)

Installation

Mounting of MG41/42 main unit

The MG41/42 main unit can be mounted to DIN rail in electrical component panel.
At factory shipment, the hook of DIN rail fixing lever is locked.
DIN rail specifications: 35 mm

1. Match the upper side of groove on the back of the MG41 main unit with the upper side of DIN rail.
2. Push and install the MG41 main unit until a click is heard so that the lower side of groove on the back of the MG41 main unit is fit into the DIN rail.

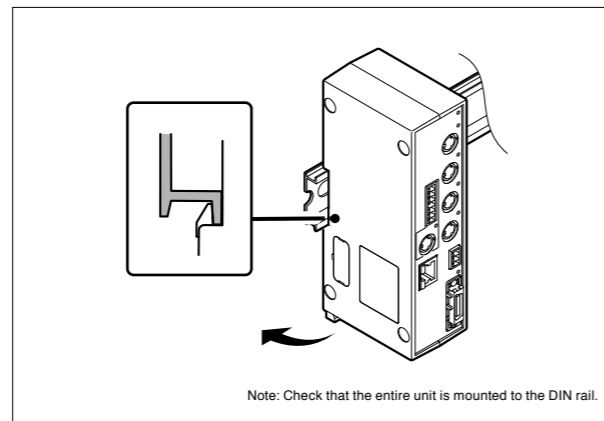
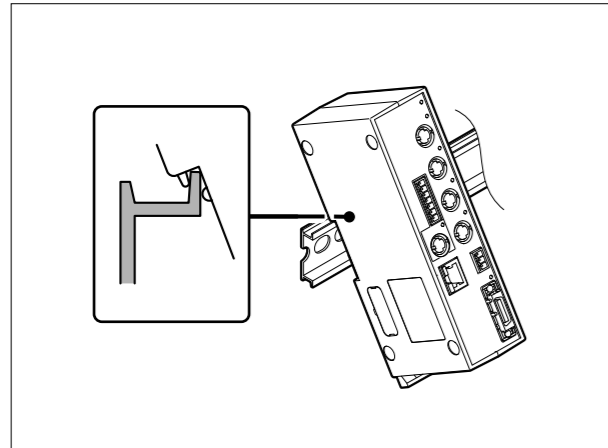

MG43 Mounting to panel

Install the main unit to panel using provided four screws (+3 × 6) and four nuts (M3).

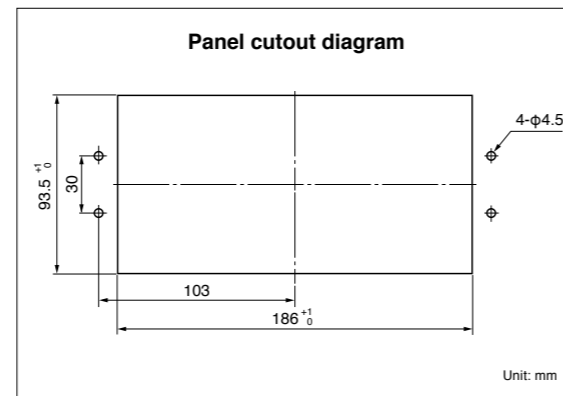
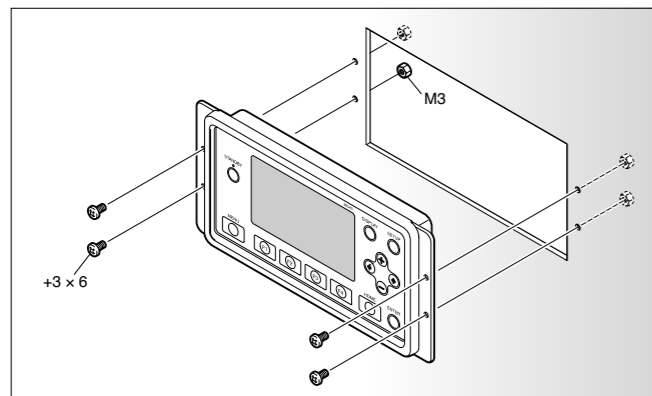

Reference: If a mounting screw hole cannot be drilled in the panel, the MG43 may be installed using four screws on the back of the main unit.

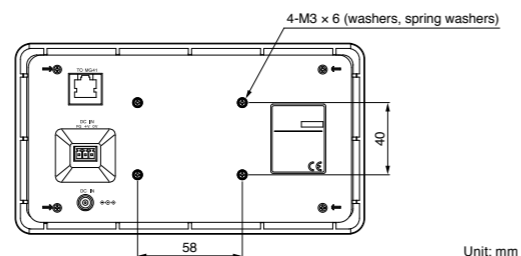

Note: Do not use a screw other than those provided for the MG43 main unit.

MG10/20/30 connection

The multi-interface unit is composed of various modules.

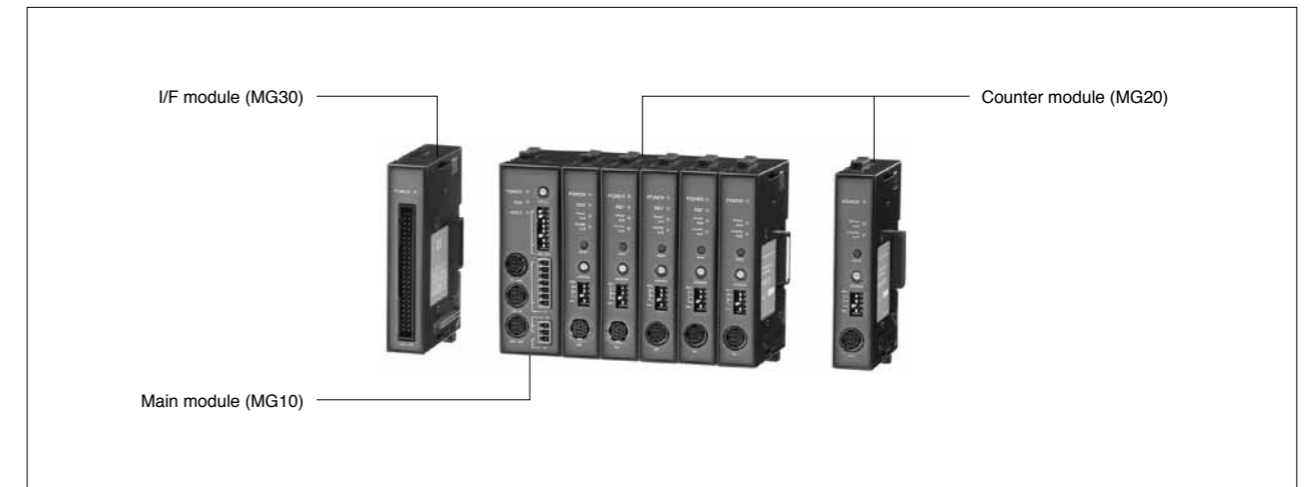

Mounting to DIN rail

1. Match the upper side of groove on the back of the unit with the upper side of DIN rail.
2. Push and install the unit until a click is heard so that the lower side of groove on the back of the unit is fit into the DIN rail.

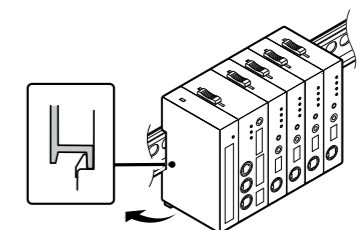
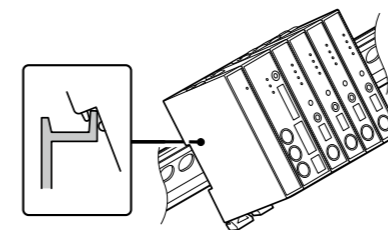

Counter

LT30 Series	34
LT11A Series	35
LT10A Series	36
LY71	37
LY72	38

LT

LT30 Series (for DK, DK-S)



- Output BCD
- Output RS-232C
- Output Go/no-go judgment

LT30-2GB

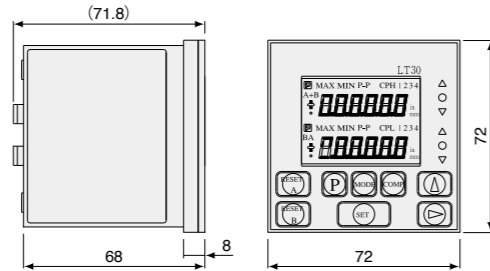

Unit: mm

Specifications						
Model	LT30-1G	LT30-1GB (BCD output model)	LT30-1GC (RS-232C input/output model)	LT30-2G	LT30-2GB (BCD output model)	LT30-2GC (RS-232C input/output model)
Number of input axes	DK Series gauges can be connected.					
	1 axis			2 axes		
Input resolution	0.1/0.5/1/5/10 μ m (parameter setting for each axis)					
Number of display axes	1 axis			2 axes		
Display data	Current, max., min., and peak-to-peak values (= max. value - min. value)			Current, max., min., and peak-to-peak values (= max. value - min. value) of each axis or A-axis display; current, max., min., and peak-to-peak values (= max. value - min. value) of 2-axis addition and subtraction B-axis display: single axis (1st or 2nd axis) (Caution for 2-axis addition or subtraction display setting: single-axis display can be only provided on monitor and cannot be operated.) (Selected by parameter setting)		
Display resolution	Same resolution as input resolution or resolution rougher than that can be selected for each axis (parameter setting).					
Direction	Parameter-based polarity setting for each axis					
Alarm display	Measuring unit unconnected, excess speed, display-digit overflow					
Addition and subtraction function	—			A+B, A-B, B-A can be set with the direction setting.		
Peak hold function	Peak calculation (max., min., and peak-to-peak values) is possible.			Peak calculation of each axis or addition/subtraction value is possible. (However, during 2-axis addition or subtraction, only 1st or 2nd axis display is possible in B-axis display.)		
Restart	Starts peak hold calculation of each axis. Operation is made by external input.			Starts peak hold calculation of each axis. Operation is made by external input (for each axis).		
Hold function (latch and pause) Latch = display and output holding Pause = peak calculation holding	Provided					
Comparator function	A set of upper and lower limits is settable.	Four sets of upper and lower limits are settable. Switching of a set is made through BCD connector.	A set of upper and lower limits is settable.	A set of upper and lower limits is settable for each axis. However, single-axis setting cannot be made during addition or subtraction.	Four sets of upper and lower limits are settable for each axis. However, single-axis setting cannot be made during addition or subtraction. Switching of a set is made through BCD connector.	A set of upper and lower limits is settable for each axis. However, single-axis setting cannot be made during addition or subtraction.
Input signal	Reset, start/latching, and pause of each axis					
	—	—	RS-TRg input (RS-232C data output command)	—	—	RS-TRg input (RS-232C data output command)
Output signal	Input circuit: Photocoupler (input voltage V = 4 to 26.4 V)					
	Comparator judgment output of each axis					
Comparator judgment output	Output circuit: NPN open collector (output voltage V = 5 to 26.4 V)					
BCD output	—	Current value and peak value (max., min., and peak-to-peak values) can be output.	—	—	Current value and peak value (max., min., and peak-to-peak values) can be output.	—
RS-232C input/output	—	—	Each function can be activated using RS-232C command instead of key operation. Current, max., min., and peak-to-peak values can be output using RS-232C data output command.	—	—	Each function can be activated using RS-232C command instead of key operation. Current, max., min., and peak-to-peak values can be output using RS-232C data output command.
Reset	Reset can be made by key operation or external reset input.					
Pre-set	Key operation		Key operation or command via RS-232C	Key operation		Key operation or command via RS-232C
Master calibration function	○					
Reference point function	○					
Key lock function	○					
Power supply	10.8 to 26.4 VDC					
Power consumption	5 W	5.5 W	5 W	8.5 W	9 W	8.5 W
Operating temperature range	0 to 40 °C					
Storage temperature range	-10 to 50 °C					
Mass	Approx. 200 g	Approx. 230 g	Approx. 220 g	Approx. 210 g	Approx. 270 g	Approx. 230 g

LT

LT11A Series (for DT512)



- Output BCD
- Output RS-232C
- Output Go/no-go judgment

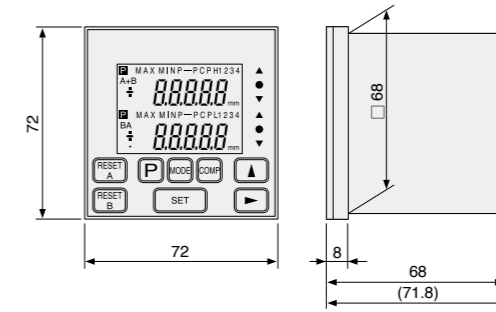

Unit: mm

Specifications						
Model	LT11A-101	LT11A-101B (BCD output model)	LT11A-101C (RS-232C input/output model)	LT11A-201	LT11A-201B (BCD output model)	LT11A-201C (RS-232C input/output model)
Number of input axes	DT512 Series gauge can be connected.					
	1 axis			2 axes		
Input resolution	1/5/10 μ m (parameter setting for each axis)					
Number of display axes	1 axis			2 axes		
Display data	Current, max., min., and peak-to-peak values (= max. value - min. value)			Current, max., min., and peak-to-peak values (= max. value - min. value) of each axis or A-axis display; current, max., min., and peak-to-peak values (= max. value - min. value) of 2-axis addition and subtraction B-axis display: single axis (1st or 2nd axis) (Caution for 2-axis addition or subtraction display setting: single-axis display can be only provided on monitor and cannot be operated.) (Selected by parameter setting)		
Display resolution	Same resolution as input resolution for each axis					
Direction	Parameter-based polarity setting for each axis					
Alarm display	Measuring unit unconnected, excess speed, display-digit overflow					
Addition and subtraction function	—			A+B, A-B, B-A can be set with the direction setting.		
Peak hold function	Peak calculation (max., min., and peak-to-peak values) is possible.			Peak calculation of each axis or addition/subtraction value is possible. (However, during 2-axis addition or subtraction, only 1st or 2nd axis display is possible in B-axis display.)		
Restart	Starts peak hold calculation. Operation is made by external input.			Starts peak hold calculation of each axis. Operation is made by external input (for each axis).		
Hold function (latch and pause) Latch = display and output holding Pause = peak calculation holding	Provided					
Comparator function	A set of upper and lower limits is settable.	Four sets of upper and lower limits are settable. Switching of a set is made through BCD terminal.	A set of upper and lower limits is settable.	A set of upper and lower limits is settable for each axis. However, single-axis setting cannot be made during addition or subtraction.	Four sets of upper and lower limits are settable for each axis. However, single-axis setting cannot be made during addition or subtraction. Switching of a set is made through BCD connector.	A set of upper and lower limits is settable for each axis. However, single-axis setting cannot be made during addition or subtraction.
Input signal	Reset, start/latching, and pause of each axis					
	—	—	RS-TRg input (RS-232C data output command)	—	—	RS-TRg input (RS-232C data output command)
Output signal	Input circuit: Photocoupler (input voltage V = 4-26.4 V)					
	Comparator judgment output of each axis					
Comparator judgment output	Output circuit: NPN open collector (output voltage V = 5-26.4 V)					
BCD output	—	Current value and peak value (max., min., and peak-to-peak values) can be output.	—	—	Current value and peak value (max., min., and peak-to-peak values) can be output.	—
RS-232C input/output	—	—	Each function can be activated using RS-232C command instead of key operation. Current, max., min., and peak-to-peak values can be output using RS-232C data output command.	—	—	Each function can be activated using RS-232C command instead of key operation. Current, max., min., and peak-to-peak values can be output using RS-232C data output command.
Reset	Reset can be made by key operation or external reset input.					
Pre-set	Key operation		Key operation or command via RS-232C	Key operation		Key operation or command via RS-232C
Master calibration function	○					
Reference point function	—					
Key lock function	○					
Power supply	9 to 26.4 VDC					
Power consumption	1.8 W	2.9 W	2.0 W	2.3 W	4.0 W	2.5 W
Operating temperature range	0 to 40 °C					
Storage temperature range	-10 to 50 °C					
Mass	Approx. 200 g	Approx. 230 g	Approx. 220 g	Approx. 210 g	Approx. 270 g	Approx. 230 g

DKS

DK

DT(MT)

U

MG

LT

LV

DKS

DK

DT(MT)

U

MG

LT

LV

LY LY72



Output RS-232C

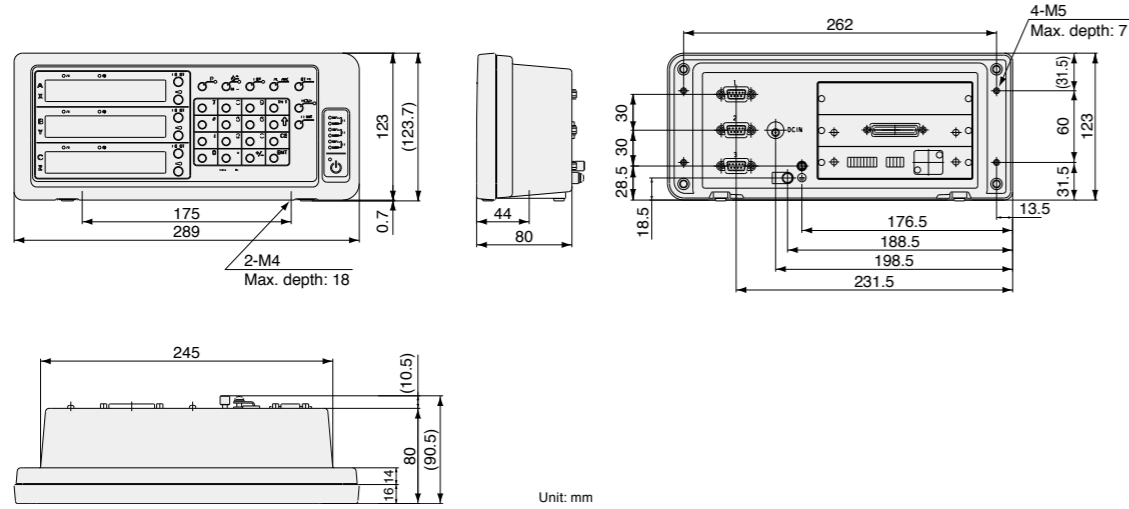

Specifications	
Model	LY72
Compatible measuring units	DK Series (connection cable CE29 required), GB-ER, SJ700A Series (Magnescale)/PL20 Series (Digiruler)
Number of input axes	1 axis, 2 axes, or 3 axes (by parameter setting)
Input resolution	Linear standard: 0.1 / 0.5 / 1 / 5 / 10 μm (expanded linear: 0.05 / 2 / 20 / 25 / 50 / 100 μm), Angle: 1 s / 10 s / 1 min / 10 min, (Expanded angle: 1 degree)
Number of display axes	3 axes (A-, B-, and C-axis display) / 3 axes (X-, Y-, and Z-axis display)
Display data	When axis label A, B, and C are selected / When axis label X, Y, and Z are selected
Display resolution	Measuring unit input resolution or more. It is possible to provide simple angle display by adhering Digiruler in arc. (There are limitations on displayable resolution depending on radius size.)
Direction	Parameter-based polarity setting for each axis
Alarm display	Measuring unit unconnected, excess speed, display-digit overflow
Addition and subtraction function	-
Peak hold function	Peak calculation of each axis is possible. / None
Restart	Starts peak hold calculation of each axis/all axes. Operation is made by key operation or general external input. / None
Hold function (latch and pause)	Operable using RS-232C command in addition to those at the left / Only latch function is possible. Operation is made by key operation or general external input only (no RS-232C command).
Comparator function	None
Positioning function	None
Input signal	External reset and external print for each axis (4 in total), 1 general input for each axis (3 in total) / External reset of each axis and general input (One of latch, reference point loaded, display switching, and preset recall is selected) / External reset of each axis and general input (One of latch, reference-point load, and pre-set recall is selected)
Output signal	1 for each axis (3 in total) / General output (One of alarm, display data, reference-point passing, and reference-point alarm is selected.) / General output (One of alarm, reference-point passing, and reference-point alarm is selected.)
Comparator judgment output	Output circuit: open collector (photocoupler) 12-24 V, isolated from internal circuit
BCD output	-
RS-232C input/output	Each function can be activated using RS-232C command instead of key operation. / Current value of each axis can be output using RS-232C data output commands. / Current value of each axis can be output using RS-232C data output command.
A/B phase output	-
Expansion unit	-
Reset	Reset can be made by key operation or external reset input.
Preset	Value is settable by key operation or using RS-232C command. A value set by external preset recall can be recalled.
Master calibration function	Provided / None
Datum point/Reference point function	Provided
Key lock function	Provided (presence/absence of setting is set by parameter)
Data storage	Storage/no-storage can be set.
Scaling function	Provided (0.100000 to 9.99999)
Linear correction	Provided (±600 μm/m)
Power supply	Optional PSC-21/22/23 adapter is used.
Power consumption	32 VA max. (when optional AC adapter is used)
Operating temperature range	0 to 40 °C
Storage temperature range	-20 to 60 °C
Mass	Approx. 1.5 kg

Technical information

LT Series Usage Notes

I/O connector

The I/O connector on the rear panel of the counter unit has functions for Go/No-go output based on the comparator function, start input, pause input, RS-232C trigger input, and reset input.

< Connector pin assignment >

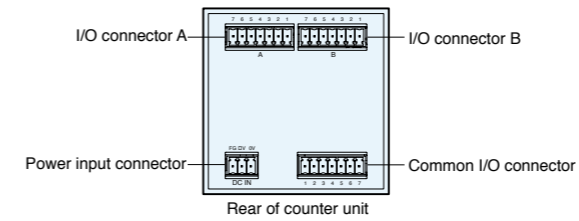

Use a shielded cable for connection to the FG pin on the rear of the counter unit. (Prepare a shield cable by yourself.)

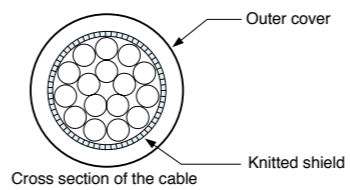

Connector used: MC1.5/7-ST-3.5 (provided) made by Phoenix Contact

I/O connector (common)

Pin No.	Signal name	IN/OUT	Description
1	GND	-	
2	START(A)	IN	Start/latch input (A)
3	PAUSE (A)	IN	Pause input (A)
4	START(B)	IN	Start/latch input (B) *1
5	PAUSE (B)	IN	RS-232C data output and trigger input *2
6	RS-TRG	IN	
7	GND	-	

*1 Connection is prohibited for 1-channel model.
*2 Connection is prohibited for models other than RS-232C model.

I/O connector description

Pin No.	Signal name	IN/OUT	Description
1	GND	-	
2	NC	-	Connection prohibited
3	RESET (A)	IN	Reset input (A CH)
4	LO (A)	OUT	Go/No-go output Low (A CH)
5	GO (A)	OUT	Go/No-go output Go (A CH)
6	HI (A)	OUT	Go/No-go output High (A CH)
7	GND	-	

I/O connector B (not provided for 1-channel models)

Pin No.	Signal name	IN/OUT	Description
1	GND	-	
2	NC	-	Connection prohibited
3	RESET (B)	IN	Reset input (B CH)
4	LO (B)	OUT	Go/No-go output Low (B CH)
5	GO (B)	OUT	Go/No-go output Go (B CH)
6	HI (B)	OUT	Go/No-go output High (B CH)
7	GND	-	

< Go/no-go judgment output >

High: Display value > upper limit → "L" (ON)
Go: Upper limit ≥ display value ≥ lower limit → "L" (ON)
Low: Lower limit > display value → "L" (ON)

Note: All go/no-go judgment outputs become "H" (OFF) if alarm occurs.

< Start/latch input >

● If judgment output is "L" (ON), the max. and min. values are set to the current value (and peak-to-peak value is "0"), and new holding starts (start function).

● When initial settings are set to shipment settings, if the measuring mode is in current value mode, go/no-go judgment output (I/O connector) and display are held at "L" (ON) (latch function).

Note: While judgment output is "L" (ON), reset/preset value recall by reset key or using an external reset/preset value recall input signal becomes invalid.

< Reset input >

Measured value is set to "0" if judgment output is "L" (ON). If a preset is made, a preset value is recalled. Note: Even if "L" (ON) is left as is, go/no-go judgment output (I/O connector) and display are not held.

Installing the LT10A/11A/30 counter unit

When mounting in a panel

- Cut out an opening to match the dimensions shown (Fig.2)
- Insert the display unit into the cut-out opening in the panel from the front.
- Attach the supplied installation brackets (upper/lower) from the rear.
- Use fingers to tighten and secure.

Note: When attaching the installation brackets to the display unit, leave sufficient space (min. 30mm) between it and the panel (Fig.3).

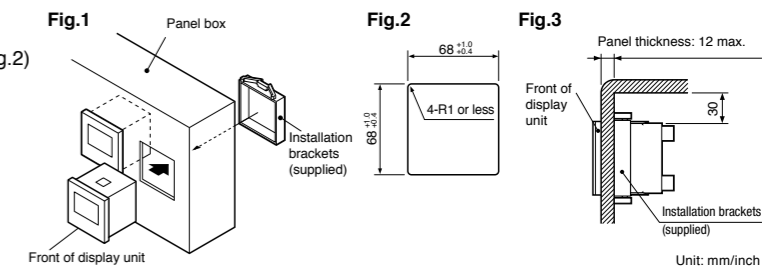

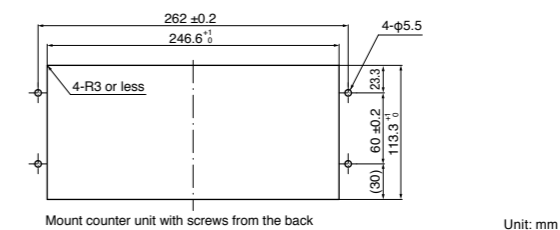

LY71/72 panel mounting

Panel cutout diagram

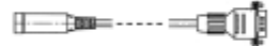

Compatibility

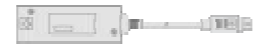
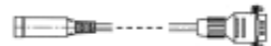
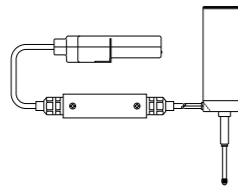
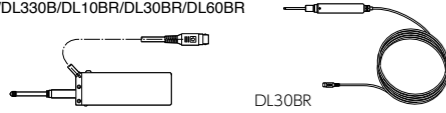
Digital gauge	Adapter/conversion cable Note 1: MT12/13 is interpolator.	Counters	Interface unit	Old counters	External device	Extension cables	
DK800A/B Series DK800S Series DK10/25/50/100/110/155/205 Series 	Unnecessary	LT30 Series	MG20-DK MG41-NE/NC MG42			CE08-1(1 m) -3(5 m) -5(5 m) -10(10 m) -15(15 m) * Total cable length is 20 m or less. CK-T12(1 m) -T13(3 m) -T14(5 m) -T15(10 m) -T16(15 m) * High-flex cable/total cable length is 20 m or less. CE27-01(1 m) -03(3 m) -05(5 m) -10(10 m) * High-flex cable/large-dia. cable/total cable length is 30 m or less.	
	CE29 Series Cable length: 0.3/1/3/5/10 m 	LH70/71/71A/72 LY71/72					CE22-01(1 m) -03(3 m) -05(5 m) -10(10 m) * High-flex cable/bare wires/total cable length is 20 m or less. CE26-01(1 m) -03(3 m) -05(5 m) -10(10 m) * High-flex cable/bare wires/large-dia. cable/total cable length is 30 m or less. CE27-01(1 m) -03(3 m) -05(5 m) -10(10 m)(extension cable for CE26) * High-flex cable/large-dia. cable/total cable length is 30 m or less.
	(Cable with bare wires) 					○: connectable A/B reference point (Differential line receiver input)	
DG Series (with HA13) * Model with no "B" assigned 	SZ05-T01	LH70/71/71A/72 LY71/72				Without extension cable * Cable may be manufactured to specified length on a production by order basis.	
	SZ05 + SZ51 – MS01			LY51/52			
	Unnecessary			LY100/110 LH20, etc.			
DT12/32 Series 	Unnecessary	LT10A Series	MG20-DT	LT10 Series		CE08-1(1 m) -3(5 m) -5(5 m) -10(10 m) -15(15 m) * Total cable length is 20 m or less. CK-T12(1 m) -T13(3 m) -T14(5 m) -T15(10 m) -T16(15 m) * High-flex cable/total cable length is 20 m or less.	
	MT12-05/10 Note 1 	LT20A Series		LT20 Series			
	MT13-05/10 Note 1 	LT30 Series					
DT512 Series 	Unnecessary	LT11A Series	MG20-DT	LT11 Series			
	MT13-01 Note 1 	LT30 Series					
DK800 Series * Models with no "A/B" assigned to model 	Unnecessary	LT30 Series	MG20-DK			CE27-01(1 m) -03(3 m) -05(5 m) -10(10 m) * High-flex cable/large-dia. cable/total cable length is 10 m or less. * When CE08-01(1 m) -03(3 m) or CK-T12(1 m) -T13(3 m) is used, the total cable length is 5 m or less.	
	CE29 Series Cable length: 0.3/1/3/5/10 m 	LH70/71/71A/72 LY71/72				CE22-01(1 m) -03(3 m) * High-flex cable/bare wires/total cable length is 5 m or less. CE26-01(1 m) -03(3 m) * High-flex cable/bare wires/large-dia. cable/total cable length is 10 m or less. CE27-01(1 m) -03(3 m) -05(5 m)(extension cable for CE26) * High-flex cable/large-dia. cable/total cable length is 10 m or less.	
	(Cable with bare wires) 					○: connectable A/B reference point (Differential line receiver input)	
DG-B Series 	DZ51 + SZ70-1	LH70/71/71A/72 LY71/72				Without extension cable * Cable may be manufactured to specified length on a production by order basis.	
	Unnecessary	LT20A Series	MG20-DG	LT20 Series			
	DZ51			LY51/52			
DE12BR/DE30BR 	SZ70-2 	LT30 Series				Without extension cable * To be supported by special specifications	
	SZ70-1	LH70/71/71A/72 LY71/72					
	Unnecessary			LY51/52			
DL310B/DL330B/DL10BR/DL30BR/DL60BR 	Unnecessary	LT20A Series	MG20-DG	LT20 Series		Without extension cable (DL310B, 330B) * Cable may be manufactured to specified length on a production by order basis. Total cable length: 10 m or less	
	DZ51 + SZ70 – 1	LH70/71/71A/72 LY71/72					
	DZ51			LY51/52			

Technical Information

Useful functions of counter units LT10A/LT11A/LT30

The combination of a high-accuracy digital gauge and an LT-series multifunction counter allows the following measurements to be made. The internal counter always holds "current value," "maximum value," "minimum value," and "peak-to-peak value" irrespective of the measuring mode (current, maximum, minimum, and peak-to-peak values).

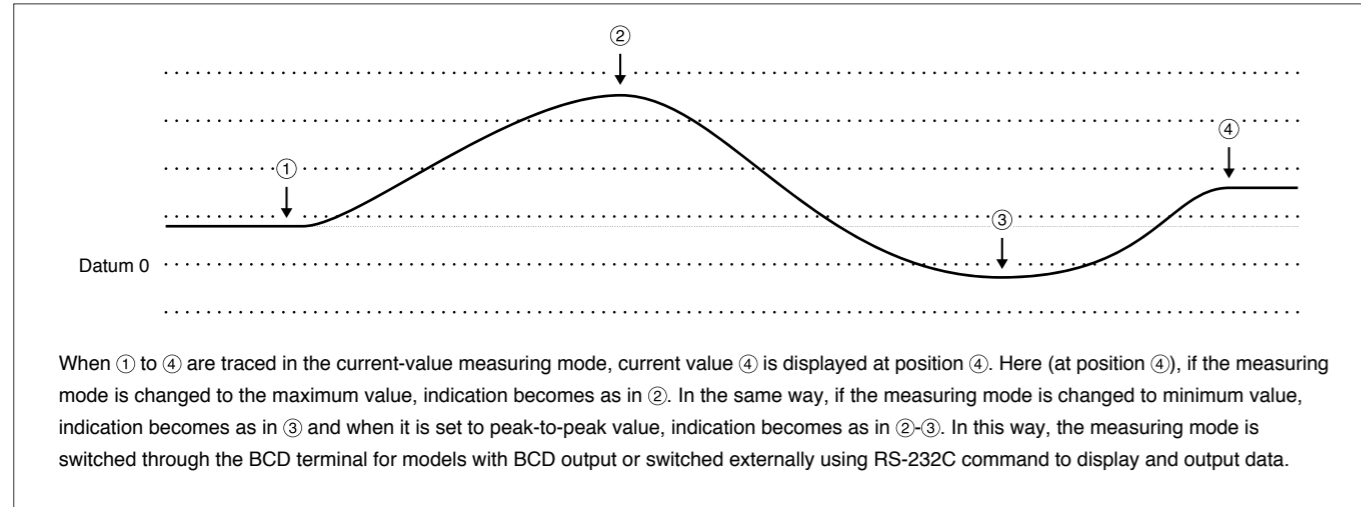

Datum-point reproduction function using a DK Series digital gauge and LT30 Series counter

Up to now, even when master (datum point) calibration is made, the current position is reset if power supply is turned OFF. Thus, master (datum point) calibration needs to be made again using the master (datum point) at power ON. The DK Series Digital Gauges incorporate the reference point; once master (datum point) calibration is made, the counter can store data and reproduce the datum point without master (datum point) calibration in the reference-point referring function.

- First, a difference value between a digital gauge's built-in reference point and master (datum point) is measured to preset the master (datum point). If the master (datum point) is 0 (zero), a difference value is preset to 0 (zero).
* The reference point is at the position where the spindle is pushed by 1 mm or more.
- When the counter's power supply is turned ON again, the counter starts up in the reference-point referring mode and display blinks in "0", causing the counter to enter reference-point detection waiting status. When the spindle is pushed and passes through the reference point, counting is made by the current value display from the master (datum point) position. (The counter stores internally a difference value between the master (datum point) and reference point in memory.)

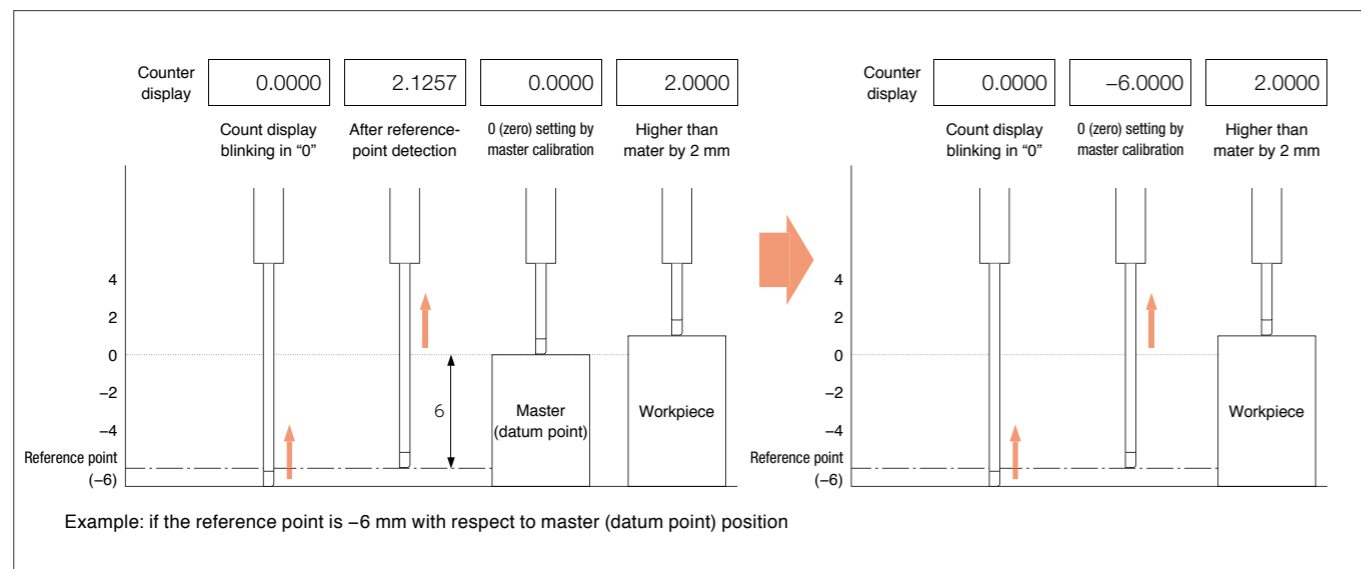

Latch function

The latch function holds output data and go/no-go judgment output with respect to its value in the current value mode.

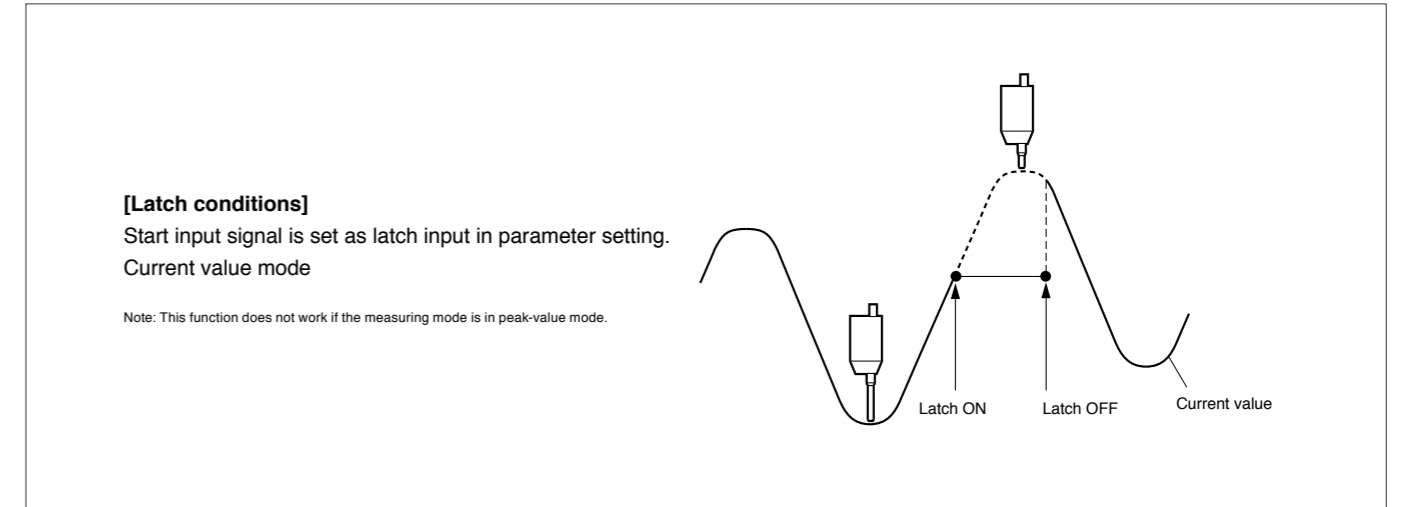

Using an LT Series Counter as a multistage comparator

For the LT Series counters, comparator settings are lower and upper limit settings as standard; no setting range can be increased. The LT Series' BCD output specifications allow up to four sets of combinations of setting values (upper and lower limits) of the comparator to be registered. This allows an LT Series counter as a multistage comparator. Combining ON/OFF of pins 35 and 36 of the BCD output connector allows four ways (4 sets) of switching to be made. (Four sets of comparators can be set from 1st set (smallest range) to 4th set (largest range).)

BCD output connector

No. 35 pin	No. 36 pin	Upper and lower limits of comparator values
H	H	Upper and lower limits of 1st set
L	H	Upper and lower limits of 2nd set
H	L	Upper and lower limits of 3rd set
L	L	Upper and lower limits of 4th set

Judgment	LED display	Conditions
High	△	Measured data > upper limit
Go	○	Upper limit ≥ measured data ≥ lower limit
Low	▽	Lower limit > measured data

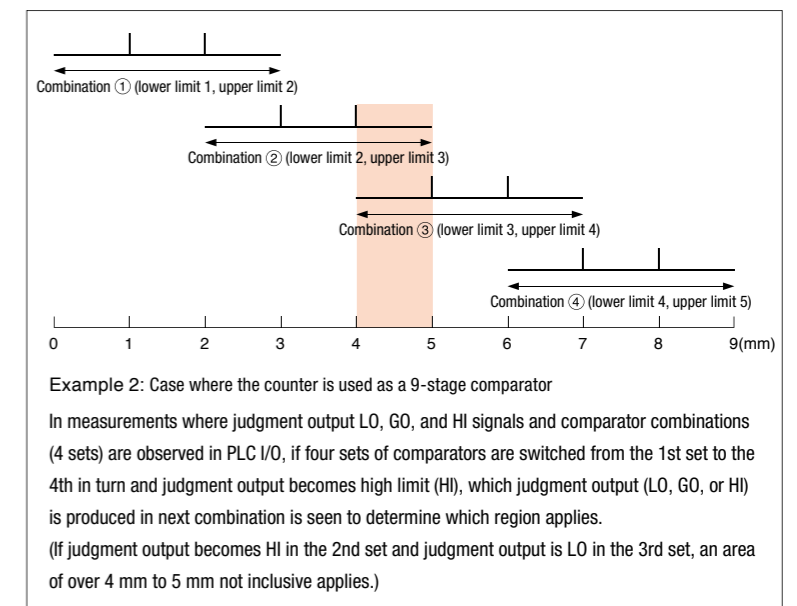
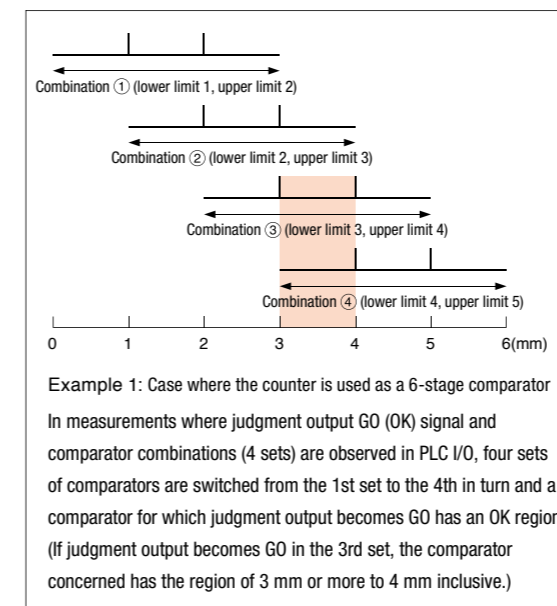

Safety

No compromise for high-accuracy products



The total quality control system that operates throughout the entire design and production process ensures products with enhanced safety, high quality, and high reliability that match our customers' requirements. The company is certified for length calibration in compliance with the traceability system required by the "Weights and Measures Act," and has been granted ISO 9001 certification, which is the international standard for quality assurance.



Magnescale Co., Ltd. is registered to ISO 9001 (Quality)

Our products comply with CE Marking requirements, have acquired UL certifications and meet other regulations, ensuring safe use the world over.

We have met:

- EMC Directives(CE)
 - EMI: EN 55011 Group 1 Class A / 91
 - EMS: EN 61000-6-2
- FCC regulation
 - FCC Part 15 Subpart B Class A

- for Products with built-in AC power supply:
 - UL61010-1 •EN61010-1
- for Products with Laser:
 - DHHS (21CFR1040.10) •IEC60825-1

* When using our devices with machines to which the European Machinery Directive applies, please make sure that the devices when installed on the machines fulfill the applicable requirements of the Directive.
* Standards or regulations to be complied with may vary by product.

Traceability

Traceability Flow Chart (Length)

