





VALVE BODY 4KAI TYPE MINI TRI-CLAMP



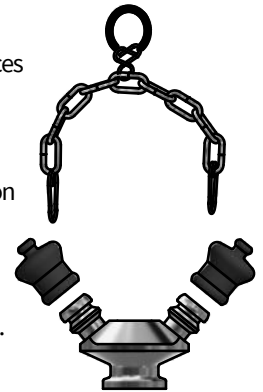

ART. NO. 440021

GENERAL

-  The KEOFITT 4KAI Sampling Valve is our low cost sterilizable sampling valve for less demanding applications. Replaces non-hygienic sampling cocks. More than 20 different configurations available.
-  The sampling valve can be used for any process sampling for chemical and/or physical analysis.
-  **Cleaning/sterilizing:** Between batches: Valve in open position: Cleanable by means of CIP using the detergent solution suitable for the actual process media. Between samples: Valve in its normal closed position: cleanable by CIP as "Between batches" or the valve may be sterilized by means of steam SIP or chemical SIP using a procedure appropriate to the actual circumstances. For further advice, please contact Keofitt.
-  Designed for sampling of liquids with a viscosity of up to approx. 100 cP containing no particles larger than Ø1.5 mm. Sampling of more viscous liquids is possible, only will it take longer (depending on process pressure).



FEATURES

-  Installation: Mini Tri-Clamp DIN 32676:2009-05 Table 4 Row C
-  Operation: Depending on choice of valve head
-  Inlet / Outlet: Hose piece
-  Membrane: Depending on choice of valve head

CERTIFICATION*

- EU EC 1935/2004 · EU EC 2023/2006 · DK No. 1248 10/2018 · 3-A Certificate · 3.1 Material Certificate
- ATEX 2014/34/EU · PED 2014/68/EU · Keofitt DoC

TECHNICAL DATA

Material (product contact)

- Steel parts AISI 316L (1.4404)

Material (without product contact)

- Steel parts AISI 316L (1.4404)
- Rubber cap EPDM (black)
- Stainless steel chain AISI 316L (1.4404)

Surface Treatment

- Outside Ra ≤ 1.2 µm
- Inside (wetted surface) Ra ≤ 0.8 µm
- Process connection Ra ≤ 0.8 µm

Pressure & Temperature

- Pressure Depending on choice of valve head
- Temperature Depending on choice of valve head
- Air supply Depending on choice of valve head

Net Weight

- kg/lbs 0.15 kg/0.331 lbs

Spareparts

- 774401 PARTS FOR 4KAI VALVE BODY

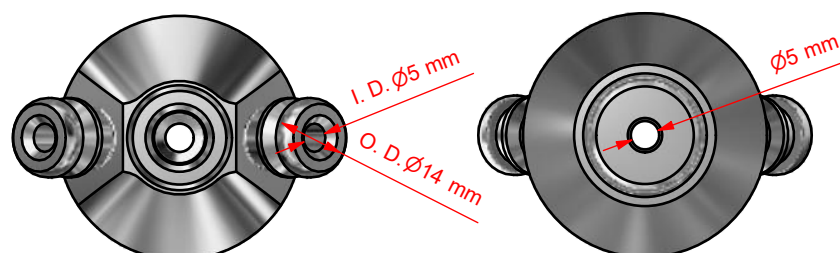
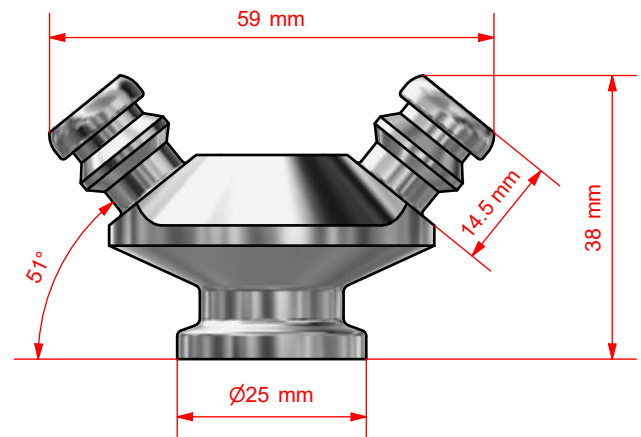

*For further information and download please visit www.keofitt.dk