

# DATA SHEET

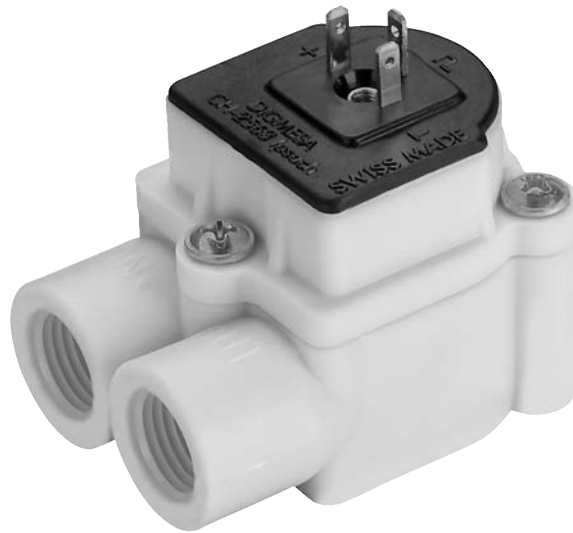

## **DIGMESA**

---

**FHK G1/4" Arnite**  
Part number: 937-15XX/F01

Digmesa AG, Keltenstrasse 31, CH-2563 Ipsach / Switzerland

Phone +41 (32) 332 77 77, Fax +41 (32) 332 77 88

[www.digmesa.com](http://www.digmesa.com)

Version 01 FHK G1/4" 937-15XX/F01 GB Page 1-9

# General Description

The FHK Flowmeter is a general-purpose device; its working range can be individually defined according to its nozzle size. It is employed for measuring, regulating or metering and guarantees most precise measurement of fluid quantities. In addition, a pulse generator integrated into the flowmeter guarantees a practically unlimited useful life.

**Specific applications:** Inlet and outlet on the same side, compact design, great working range, depending on the nozzle diameter.

## Approvals / Standards

EN55014-1:00+A1:01+A2:02, EN61000-6-3:01+A11:04, IEC61000-6-3:06(ed.2.0), EN61000-3-2:06, IEC61000-3-2:05(ed.3.0), EN61000-3-3:95+A1:01+A2:05, IEC61000-3-3:94+A1:01+A2:05(Cons.ed 1.2), EN55014-2:97+A1:01, EN61000-6-1:01, IEC61000-6-1:05(ed.2)



## Material:

Housing: PBT 35%GF (Arnite)  
 Bearing pin: Inox 1.4305 (18/8)  
 Nozzel: Ø 1.0, 1.2, 2.0, 2.5mm  
 PPS 40%GF (Ryton)  
 Nozzel: Ø 5.6mm like housing  
 O-ring: MVQ (Silikon)  
 Turbine: PVDF  
 Magnets: Keramik Sr Fe O  
 (in contact with the medium)  
 Screw: PT-screws  
 (Phillips cross recessed)

## Technical data:

Flow rate: 0.027 - 8.30 l/min depending on the nozzle diameter  
 Measuring accuracy: +/- 2.0%  
 Repetition: < +/- 0.25%  
 Temperature range: -10°C to +65°C  
 14°F to 149°F  
 Pressure range: 20 bar at 20°C  
 290 psi /68°F  
 Mounting position: Horizontal \*  
 Nozzle size: Ø 1.0, 1.2, 2.0, 2.5, 5.6mm

## Electrical connection ratings:

Power supply: +3.8 to +24 VDC  
 Consumption: < 8 mA  
 Signal connection: Open collector NPN  
 Signal voltage: 0 VDC GND  
 (saturation < 0.7 V)  
 Signal load: max. 20 mA  
 Leakage current: max. 10 µA  
 Connections: 3-pin AMP 2.8 x 0.8 mm  
 Signal: Square-wave output  
 Duty Cycle: ~ 50%

## Dimensions in mm:

\* Horizontal position is, when the contacts facing up.

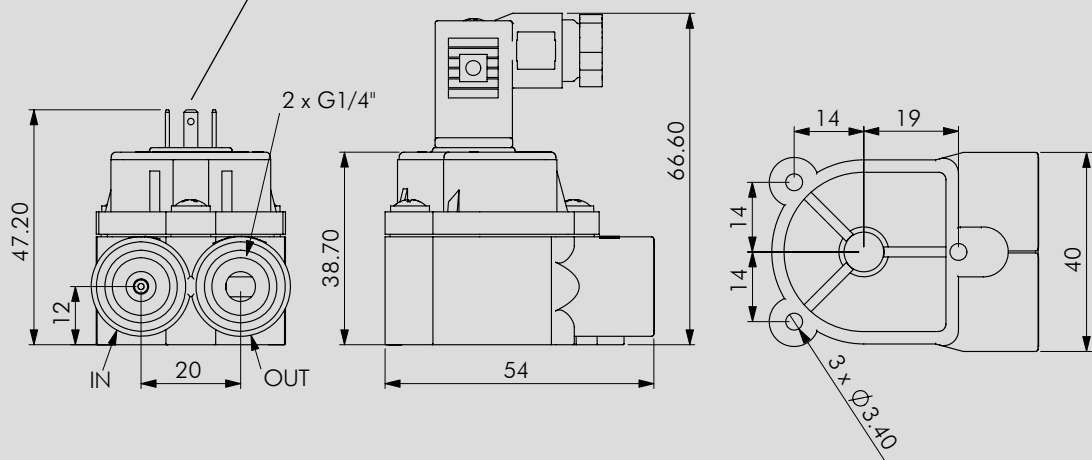

## Options:

3-pin solenoid socket  
 Item number: 941-0002/3



We reserve the right to make modifications in the interests of technical progress.

## RESISTANCE

Special regulations which must be complied with by the flowmeter manufacturer apply to each country, e.g. CE, NSF, FDA and SK. The various media flowing through the flowmeter differ from application to application. You are advised to enquire with the medium manufacturer as to whether the entire installation and the flowmeter are resistant to the medium itself (see Material)!

## ELECTRONIC

DIGMESA electronic circuitry is always designed for operation with DIGMESA flowmeters. Please note the following if connecting to other electronic circuitry:

- The flowmeter does not supply an output voltage but switches the signal terminal to 0 V ground (actuated) or leaves it open (non-actuated)
- There must be a pull-up resistor between power supply + and signal depending on electronic circuitry!

Version 01 FHK G1/4" 937-15XV/F01 GB Page 2-9

# Interface Connection: Examples Open Collector

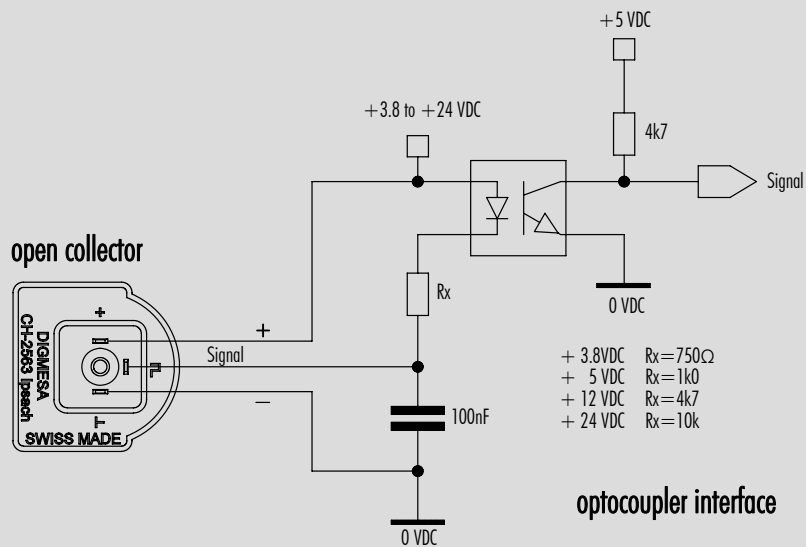
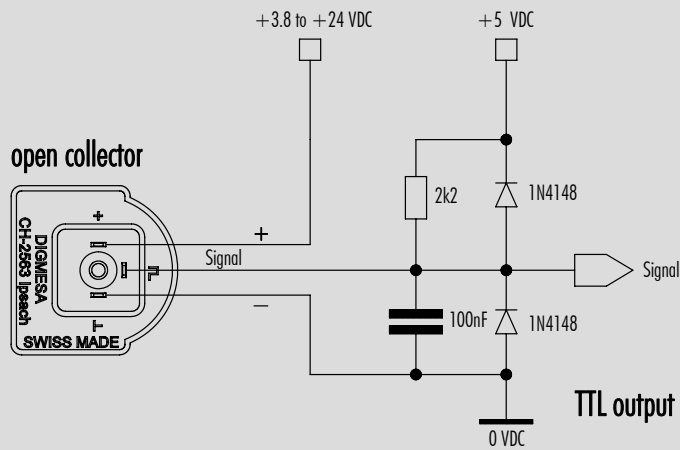
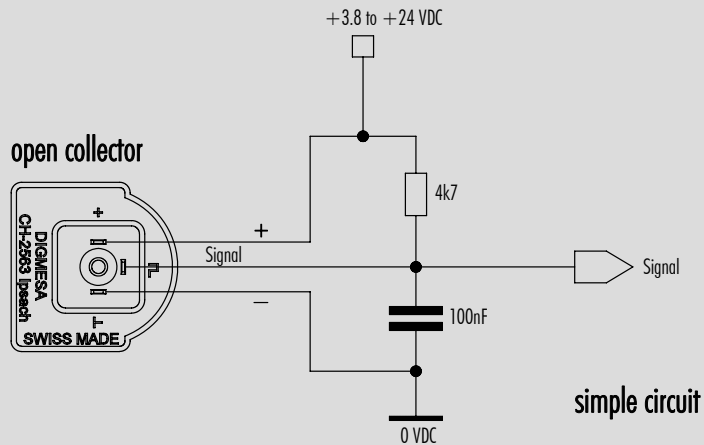

# Measurement Curve FHK 1.00 mm (#937-1510/F01)

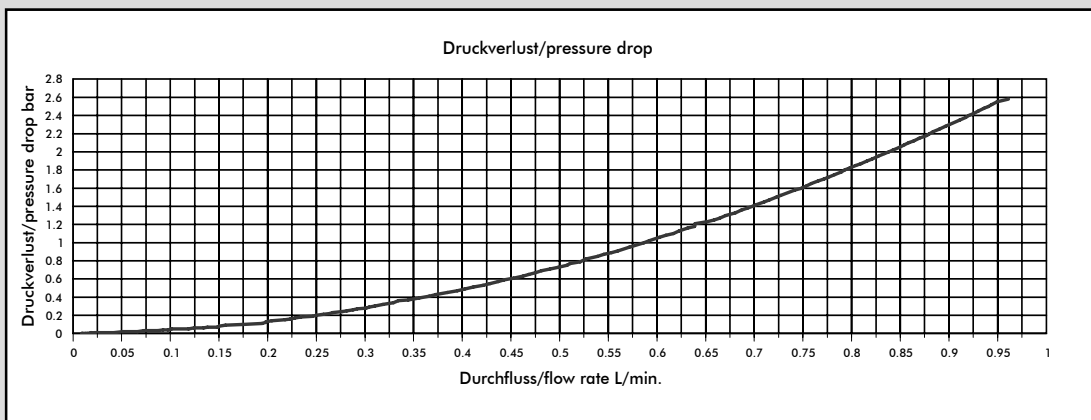
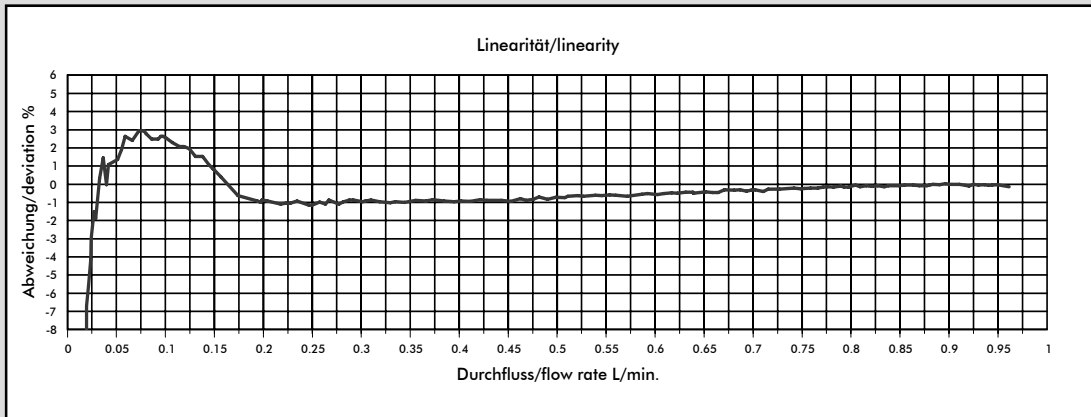

Medium: Water / max. Pressure: 3.3 bar

| Nozzle size | Pulses/litre | g/pulse | min. flow rate in litres/min at Linear start | max. flow rate in litres/min | Pressure loss |
|-------------|--------------|---------|--|------------------------------|---------------|
| Ø 1.00 mm   | 2223         | 0.4499  | 0.0274                                       | 0.5867                       | 1.00          |
| Ø 1.20 mm   | 1787         | 0.5595  | 0.0315                                       | 0.7777                       | 1.00          |
| Ø 2.00 mm   | 1013         | 0.9869  | 0.1109                                       | 2.3268                       | 1.00          |
| Ø 2.50 mm   | 754          | 1.3252  | 0.0673                                       | 2.7421                       | 0.60          |
| Ø 5.60 mm   | 256          | 3.9100  | 0.1802                                       | 8.3080                       | 0.90          |

## MEASUREMENT TIPS

- Ensure that there is no fast-pulsatory movement of the media
- Ensure that there are no reverse pressure surges
- Ensure that there is no air in the system
- Note the mounting position of the flowmeter
- Min/max flow should be in the linear range of the selected flowmeter
- Clean the system at appropriate intervals
- Avoid electrical current peaks
- Incorrect cabling of power supply +, signal and ground will destroy the flowmeter
- Do not mechanically load electrical contacts
- Avoid moisture on the electrical contacts
- Avoid stray pick-up via the cable (Do not lay cables in parallel with high current loads)

**The values specified must be considered as approximate values.**

**The number of pulses per litre may differ depending on medium and installation.**

**We recommend to calibrate the number of pulses per litre in line with the complete installation.**

# Measurement Curve FHK 1.20 mm (#937-1512/F01)

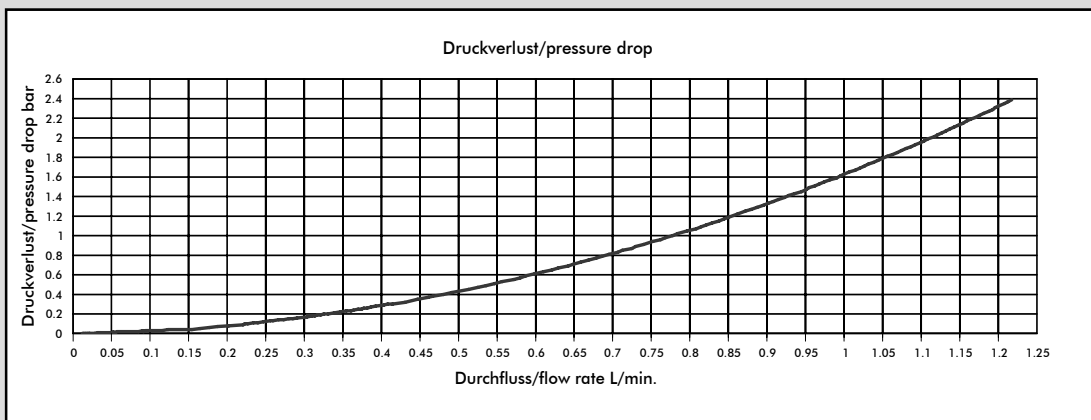
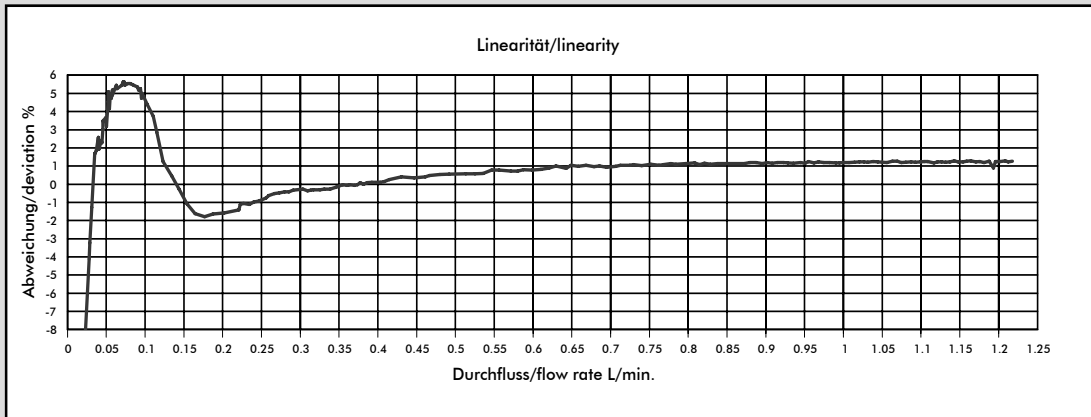

Medium: Water / max. Pressure: 3.3 bar

| Nozzle size | Pulses/litre | g/pulse | min. flow rate in litres/min at Linear start | max. flow rate in litres/min | Pressure loss |
|-------------|--------------|---------|--|------------------------------|---------------|
| Ø 1.00 mm   | 2223         | 0.4499  | 0.0274                                       | 0.5867                       | 1.00          |
| Ø 1.20 mm   | 1787         | 0.5595  | 0.0315                                       | 0.7777                       | 1.00          |
| Ø 2.00 mm   | 1013         | 0.9869  | 0.1109                                       | 2.3268                       | 1.00          |
| Ø 2.50 mm   | 754          | 1.3252  | 0.0673                                       | 2.7421                       | 0.60          |
| Ø 5.60 mm   | 256          | 3.9100  | 0.1802                                       | 8.3080                       | 0.90          |

## MEASUREMENT TIPS

- Ensure that there is no fast-pulsatory movement of the media
- Ensure that there are no reverse pressure surges
- Ensure that there is no air in the system
- Note the mounting position of the flowmeter
- Min/max flow should be in the linear range of the selected flowmeter
- Clean the system at appropriate intervals
- Avoid electrical current peaks
- Incorrect cabling of power supply +, signal and ground will destroy the flowmeter
- Do not mechanically load electrical contacts
- Avoid moisture on the electrical contacts
- Avoid stray pick-up via the cable (Do not lay cables in parallel with high current loads)

**The values specified must be considered as approximate values.**

**The number of pulses per litre may differ depending on medium and installation.**

**We recommend to calibrate the number of pulses per litre in line with the complete installation.**

# Measurement Curve FHK 2.00 mm (#937-1520/F01)

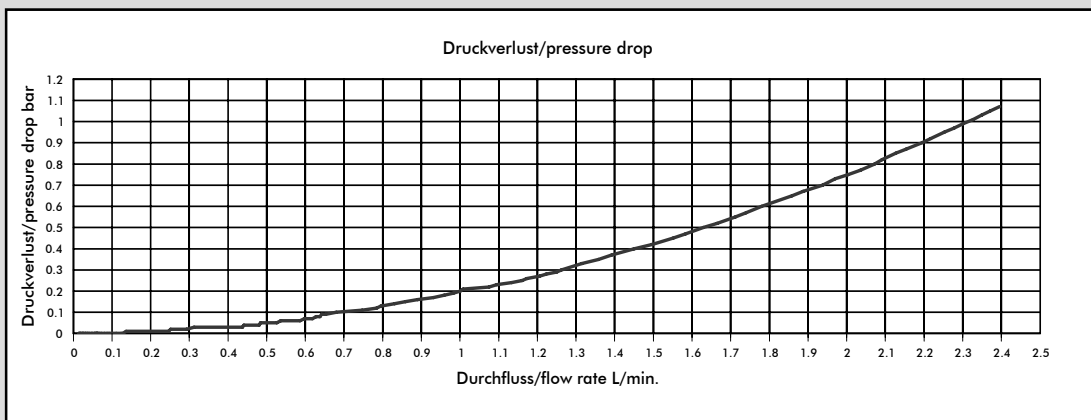
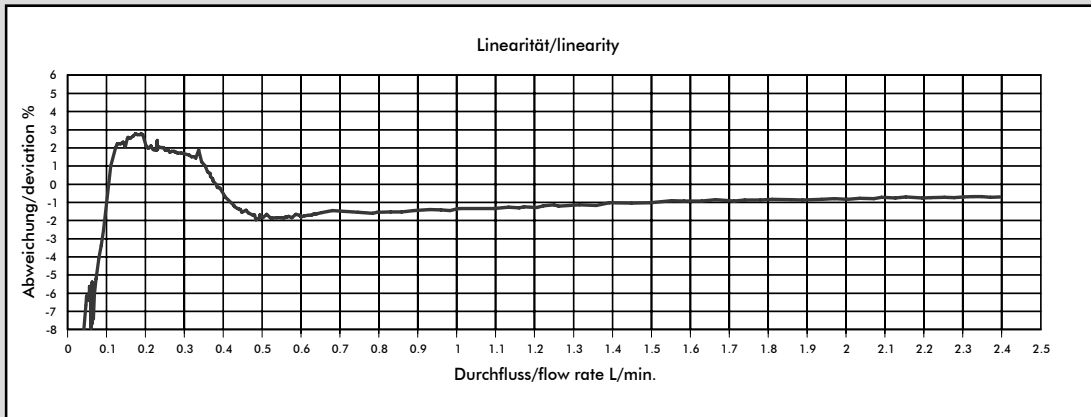

Medium: Water / max. Pressure: 3.3 bar

| Nozzle size | Pulses/litre | g/pulse | min. flow rate in litres/min at Linear start | max. flow rate in litres/min | Pressure loss |
|-------------|--------------|---------|--|------------------------------|---------------|
| Ø 1.00 mm   | 2223         | 0.4499  | 0.0274                                       | 0.5867                       | 1.00          |
| Ø 1.20 mm   | 1787         | 0.5595  | 0.0315                                       | 0.7777                       | 1.00          |
| Ø 2.00 mm   | 1013         | 0.9869  | 0.1109                                       | 2.3268                       | 1.00          |
| Ø 2.50 mm   | 754          | 1.3252  | 0.0673                                       | 2.7421                       | 0.60          |
| Ø 5.60 mm   | 256          | 3.9100  | 0.1802                                       | 8.3080                       | 0.90          |

## MEASUREMENT TIPS

- Ensure that there is no fast-pulsatory movement of the media
- Ensure that there are no reverse pressure surges
- Ensure that there is no air in the system
- Note the mounting position of the flowmeter
- Min/max flow should be in the linear range of the selected flowmeter
- Clean the system at appropriate intervals
- Avoid electrical current peaks
- Incorrect cabling of power supply +, signal and ground will destroy the flowmeter
- Do not mechanically load electrical contacts
- Avoid moisture on the electrical contacts
- Avoid stray pick-up via the cable (Do not lay cables in parallel with high current loads)

**The values specified must be considered as approximate values.**

**The number of pulses per litre may differ depending on medium and installation.**

**We recommend to calibrate the number of pulses per litre in line with the complete installation.**

# Measurement Curve FHK 2.50 mm (#937-1525/F01)

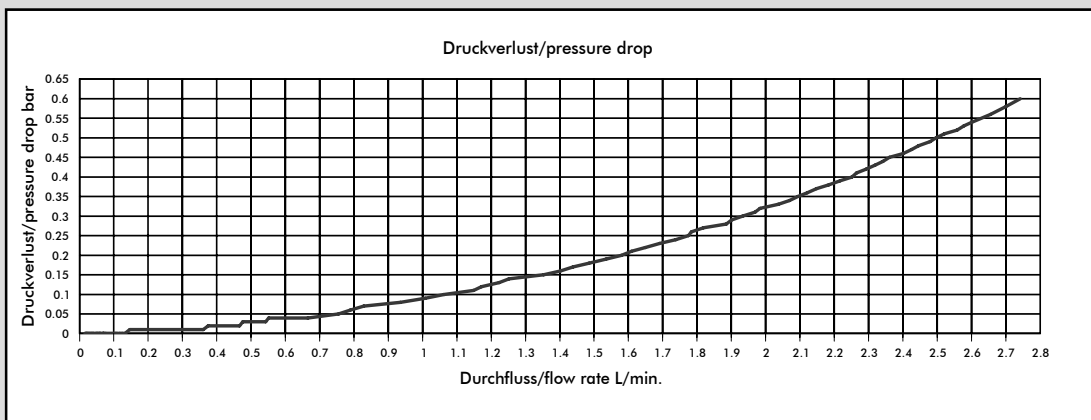
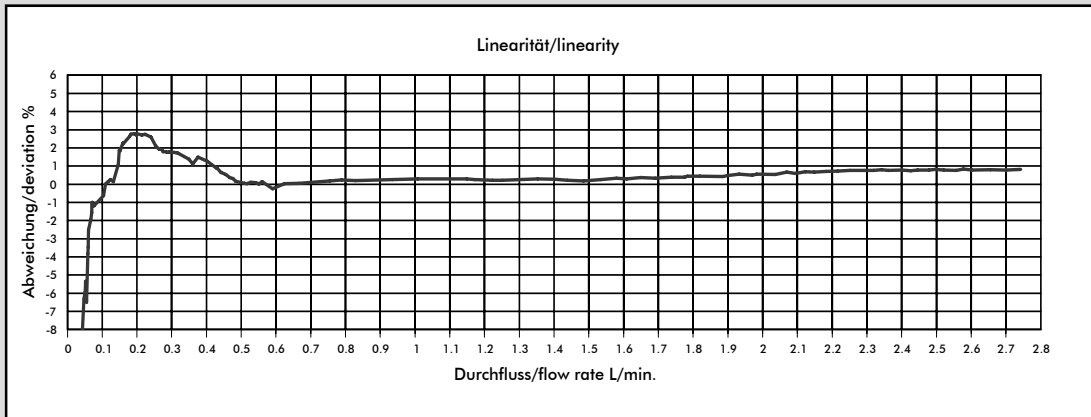

Medium: Water / max. Pressure: 3.3 bar

| Nozzle size | Pulses/litre | g/pulse | min. flow rate in litres/min at Linear start | max. flow rate in litres/min | Pressure loss |
|-------------|--------------|---------|--|------------------------------|---------------|
| Ø 1.00 mm   | 2223         | 0.4499  | 0.0274                                       | 0.5867                       | 1.00          |
| Ø 1.20 mm   | 1787         | 0.5595  | 0.0315                                       | 0.7777                       | 1.00          |
| Ø 2.00 mm   | 1013         | 0.9869  | 0.1109                                       | 2.3268                       | 1.00          |
| Ø 2.50 mm   | 754          | 1.3252  | 0.0673                                       | 2.7421                       | 0.60          |
| Ø 5.60 mm   | 256          | 3.9100  | 0.1802                                       | 8.3080                       | 0.90          |

## MEASUREMENT TIPS

- Ensure that there is no fast-pulsatory movement of the media
- Ensure that there are no reverse pressure surges
- Ensure that there is no air in the system
- Note the mounting position of the flowmeter
- Min/max flow should be in the linear range of the selected flowmeter
- Clean the system at appropriate intervals
- Avoid electrical current peaks
- Incorrect cabling of power supply +, signal and ground will destroy the flowmeter
- Do not mechanically load electrical contacts
- Avoid moisture on the electrical contacts
- Avoid stray pick-up via the cable (Do not lay cables in parallel with high current loads)

**The values specified must be considered as approximate values.**

**The number of pulses per litre may differ depending on medium and installation.**

**We recommend to calibrate the number of pulses per litre in line with the complete installation.**

# Measurement Curve FHK 5.60 mm (#937-1556/01)

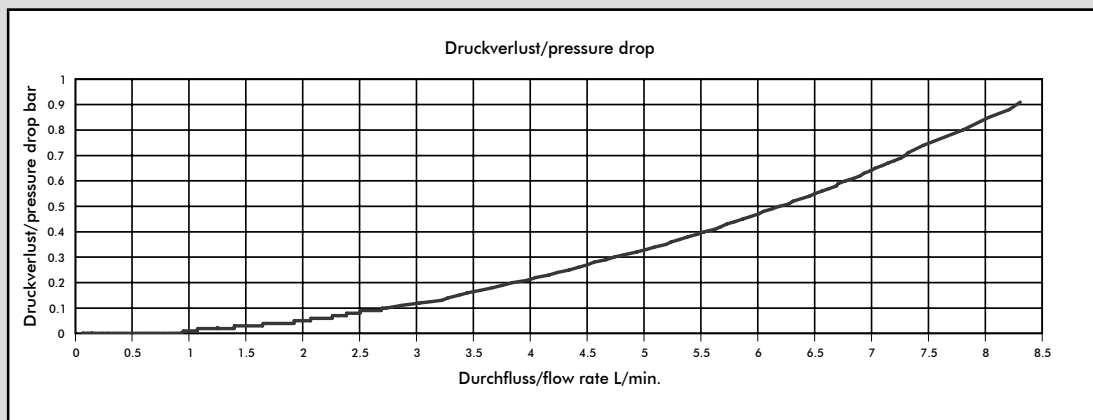
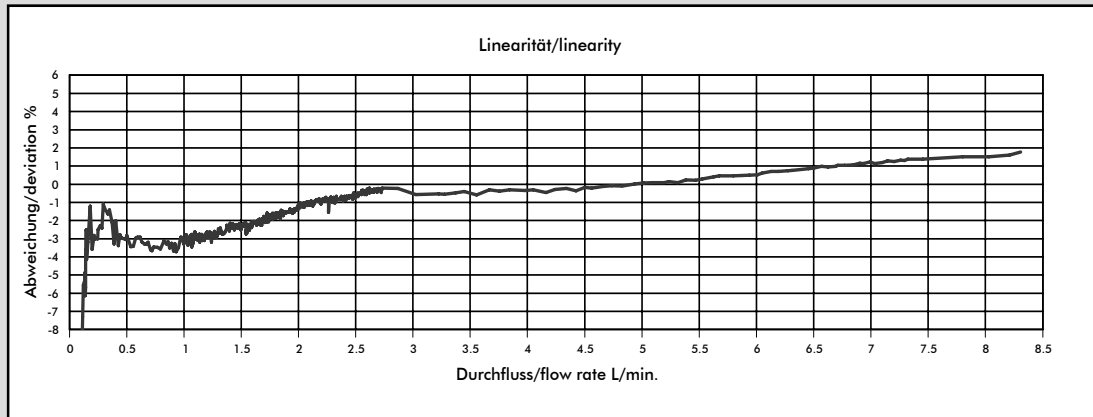

Medium: Wasser / max. Druck: 3.3 bar

| Nozzle size | Pulses/litre | g/pulse | min. flow rate in litres/min at Linear start | max. flow rate in litres/min | Pressure loss |
|-------------|--------------|---------|--|------------------------------|---------------|
| Ø 1.00 mm   | 2223         | 0.4499  | 0.0274                                       | 0.5867                       | 1.00          |
| Ø 1.20 mm   | 1787         | 0.5595  | 0.0315                                       | 0.7777                       | 1.00          |
| Ø 2.00 mm   | 1013         | 0.9869  | 0.1109                                       | 2.3268                       | 1.00          |
| Ø 2.50 mm   | 754          | 1.3252  | 0.0673                                       | 2.7421                       | 0.60          |
| Ø 5.60 mm   | 256          | 3.9100  | 0.1802                                       | 8.3080                       | 0.90          |

## MEASUREMENT TIPS

- Ensure that there is no fast-pulsatory movement of the media
- Ensure that there are no reverse pressure surges
- Ensure that there is no air in the system
- Note the mounting position of the flowmeter
- Min/max flow should be in the linear range of the selected flowmeter
- Clean the system at appropriate intervals
- Avoid electrical current peaks
- Incorrect cabling of power supply +, signal and ground will destroy the flowmeter
- Do not mechanically load electrical contacts
- Avoid moisture on the electrical contacts
- Avoid stray pick-up via the cable (Do not lay cables in parallel with high current loads)

**The values specified must be considered as approximate values.**

**The number of pulses per litre may differ depending on medium and installation.**

**We recommend to calibrate the number of pulses per litre in line with the complete installation.**



## Spare parts:

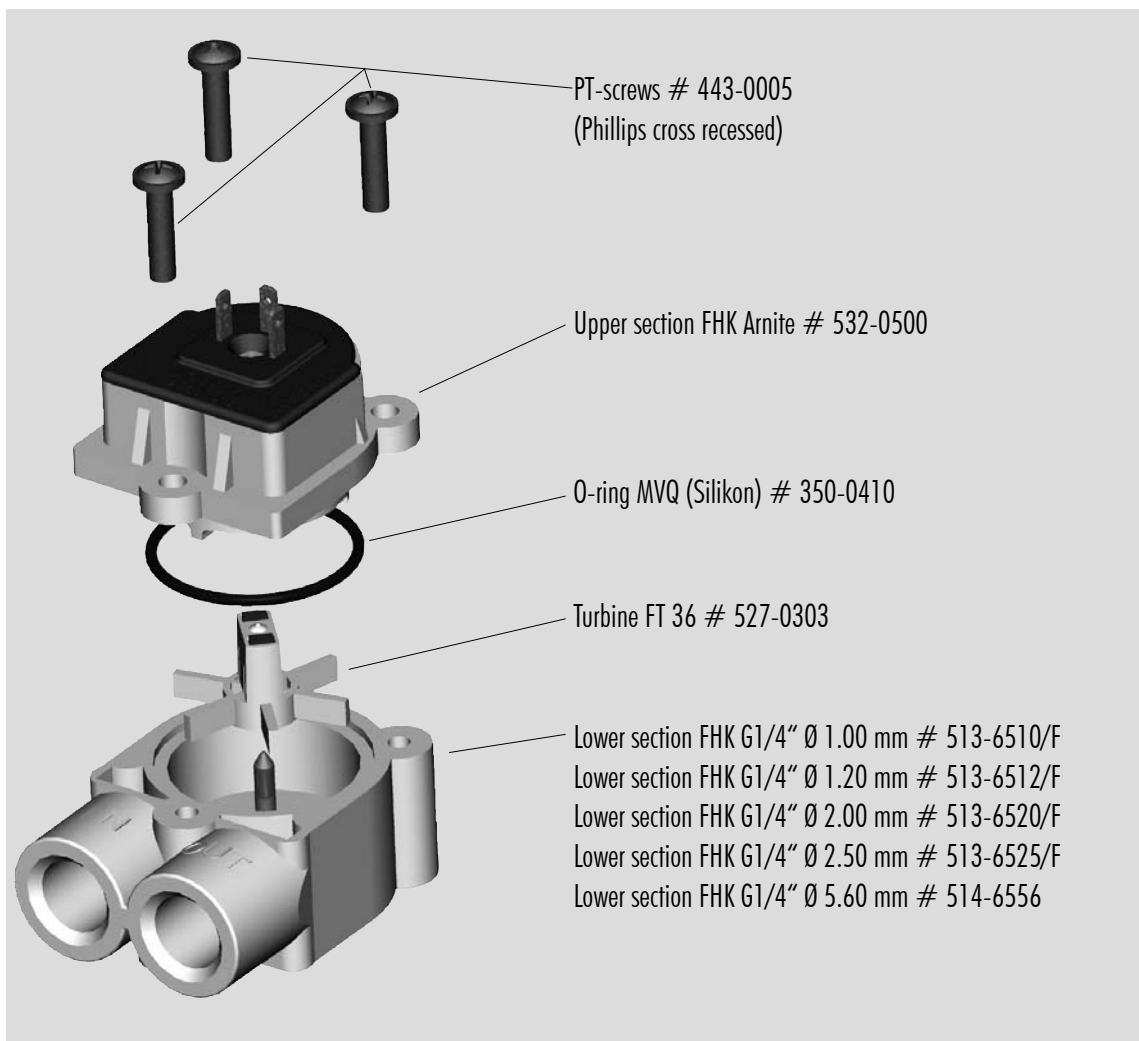

### Notes:

|        |  |  |
|--------|--|--|
| Notes: |  |  |
|        |  |  |
|        |  |  |
|        |  |  |
|        |  |  |
|        |  |  |
|        |  |  |
|        |  |  |
|        |  |  |
|        |  |  |
|        |  |  |
|        |  |  |
|        |  |  |
|        |  |  |
|        |  |  |
|        |  |  |
|        |  |  |
|        |  |  |
|        |  |  |
|        |  |  |
|        |  |  |
|        |  |  |
|        |  |  |
|        |  |  |
|        |  |  |
|        |  |  |
|        |  |  |
|        |  |  |
|        |  |  |