

GS 61

Forked photoelectric sensor

en 07-2016/01 50111253-02

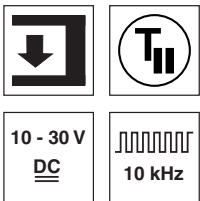

3mm

- Optical forked photoelectric sensor with 3mm mouth width for exact detection of labels on base material
- Simple sensitivity adjustment via multiturn potentiometer or optionally via teach-in function
- **NEW** – slim-line design (reduced fork height) for installation directly on the dispensing edge
- **NEW** – Removable operating head for easy parameter adjustment without tools
- **NEW** – Smallest dimensions of all industrial forked photoelectric sensors with an excellent price / performance ratio
- **NEW** – Easy adjustment via lockable teach button or teach input

Dimensioned drawing

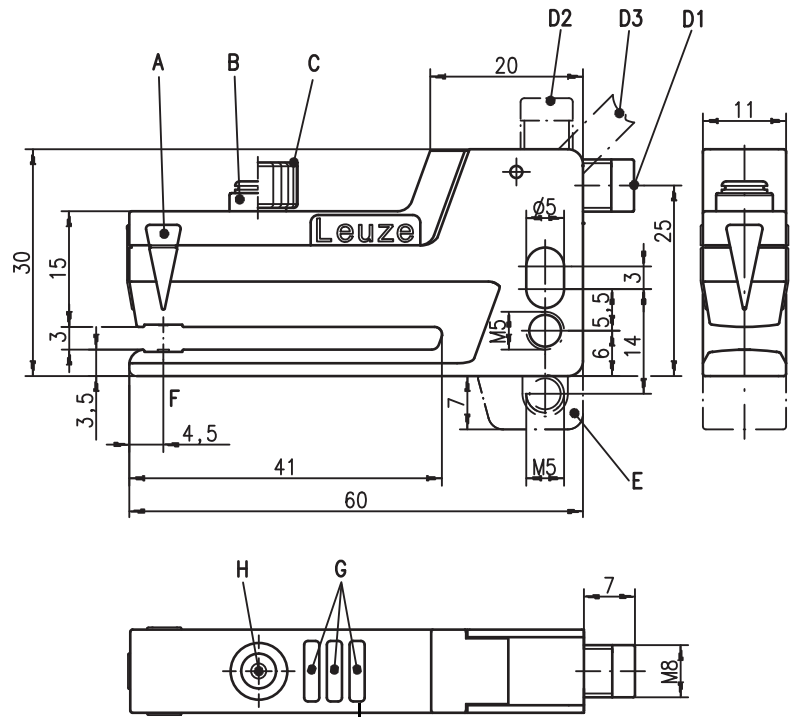

This LED has no function on the GS 61 with potentiometer

- A Label centre position
- B Control element
- C Knurled knob (removable)
- D D1: horizontal connector, D2: vertical connector, D3: cable
- E Mounting device BT-GS6X; BT-GS6X.L
- F Optical axis
- G Indicator diodes
- H Teach button

Electrical connection

Connector, 4-pin

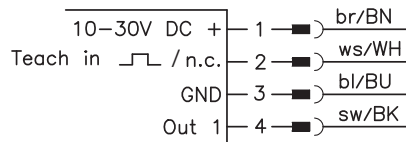

Connector, 3-pin

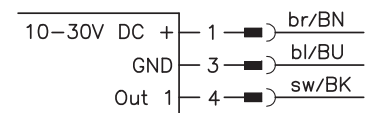

Cable

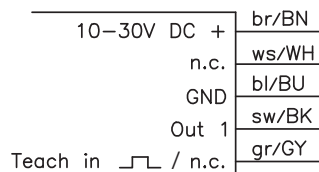

Connector, 5-pin

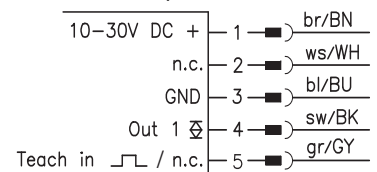

Accessories:

(available separately)

- Mounting device BT-GS6X (Part No. 50110803)
- Mounting device BT-GS6X.L (Part No. 50112215)
- Mounting device BT-GS6X.H (Part No. 50123869)

We reserve the right to make changes • DS_GS61_en_50111253_02.fm



Specifications

Physical data

Mouth width	3mm
Mouth depth	40mm
Label width	≥ 2mm
Label gap	≥ 2mm
Light source	940nm (infrared light)
Switching frequency	max. 10kHz
Conveyor speed with teach-in	≤ 20m/min (0.3m/s)
Typ. response time	50µs
Repeatability	see diagrams
Delay before start-up	≤ 300ms acc. to IEC 60947-5-2

Electrical data

Operating voltage U_B ¹⁾	10 ... 30VDC (incl. residual ripple)
Residual ripple	≤ 15% of U_B
Open-circuit current	≤ 30mA
Switching output ²⁾	1 push-pull switching output
switching signal in the label gap	Pin 4: PNP gap signal, NPN label signal
.../6D	1 push-pull switching output
signal on the label	Pin 4: PNP label signal, NPN gap signal
Signal voltage high/low	≥ ($U_B - 2V$) / ≤ 2V
Output current	≤ 100mA
Capacitive load	≤ 0.2µF ³⁾

Indicators

Green LED	ready
Green LED, flashing	teach-in activated
Yellow LED	switching signal in the label gap
Red LED (GS 61/... 2... only)	teach error / function error

Mechanical data

Housing base	PC plastic, black RAL 9005
Upper part of housing	PC plastic, red RAL 3000
Optics	PC plastic
Weight	20g with connector 70g with cable
Connection type	M8 connector, 4-pin, or M8 connector, 3-pin, or cable 2m (cross section 5 x 0.2mm ²) max. 3Nm
Tightening torque of fastening screws	

Environmental data

Ambient temp. (operation/storage)	-20°C ... +60°C / -30°C ... +70°C
Protective circuit ⁴⁾	1, 2
VDE safety class	III
Protection class	IP 65 with mounted connector
Standards applied	IEC 60947-5-2
Certifications	UL 508, CSA C22.2 No.14-13 ^{1) 5)}

- 1) For UL applications: for use in class 2 circuits according to NEC only
- 2) The push-pull switching outputs must not be connected in parallel
- 3) Max. permissible input capacitance of a consumer connected to the switching output that can be switched without activation of short-circuit-current limiting.
- 4) 1=polarity reversal protection, 2=short-circuit protection for all outputs
- 5) These proximity switches shall be used with UL Listed Cable assemblies rated 30V, 0.5A min, in the field installation, or equivalent (categories: CYJV/CYJV7 or PVVA/PVVA7)

Order guide

The sensors listed here are preferred types; current information at www.leuze.com.

	Designation	Part No.
Teach-In	GS61/6.2-S8	501 10108
	GS61/6D.2-S8	501 10109
	GS61/6.2-S8V	501 10763
	GS61/6D.2-S8V	501 10764
	GS61/6.2-S8.3	501 10765
	GS61/6D.2-S8.3	501 10766
	GS61/6.2	501 10767
	GS61/6D.2	501 10768
Potentiometer	GS61/6-S8	501 10110
	GS61/6D-S8	501 10111
	GS61/6-S8V	501 10112
	GS61/6D-S8V	501 10113
	GS61/6-S8.3	501 10761
	GS61/6D-S8.3	501 10762
	GS61/6	501 10769
	GS61/6D	501 10770

Marking on the sensor

- Align the label tape according to the sensor's marker "Label centre position".

Diagrams

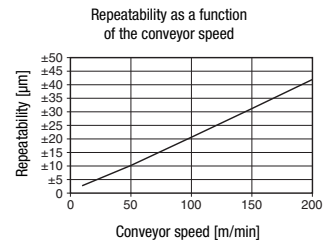

Remarks

Operate in accordance with intended use!

- ⚠ This product is not a safety sensor and is not intended as personnel protection.
- ⚠ The product may only be put into operation by competent persons.
- ⚠ Only use the product in accordance with the intended use.

GS 61

Forked photoelectric sensor

Type key

GS 61 / 6D . 2 - S8V . 3

Operating principle

GS Forked sensor, optical

Series

61 Small series with excellent price / performance ratio

Output function

/6 Push-pull output: PNP signal in the label gap, NPN signal on the label

/6D Push-pull output: PNP signal on the label, NPN signal in the label gap

Configuration

N/A Potentiometer adjustment

.2 Teach button on the device

.3 Teach button on the device and teach input

Electrical connection

N/A Device with cable, standard length 2000mm, cable outlet at 45°

-S8 M8 connector, 4-pin, horizontal plug outlet

-S8V M8 connector, 4-pin, vertical plug outlet

-S8.3 M8 connector, 3-pin, horizontal plug outlet

-S8V.3 M8 connector, 3-pin, vertical plug outlet

,200-S12 200mm cable with M12 connector, 5-pin, cable outlet at 45°

Sensor adjustment via potentiometer for GS 61

Notice: A removable operating head is plugged on the potentiometer in ex works. This can be used to manually adjust the forked photoelectric sensor without the use of a tool. If this is not desired, the operating head can be pulled off – a screwdriver is then necessary for making adjustments.

The following description applies to a forked photoelectric sensor with switching signal in the label gap (GS 61/6...). For device versions with switching signal on the label (GS 61/6D...), the LED indicators are inverted.

Preparation: Remove one or more labels from the base material and advance this blank area into the sensor.

- If the yellow OUT LED does not switch on when the blank area is encountered, increase the sensitivity by turning the potentiometer clockwise until the yellow OUT LED switches on.
- Starting from this setting, turn the potentiometer clockwise another approx. one half turn.
- Now advance the label tape so that a label is in the sensor.
- If set correctly, the yellow OUT LED must now switch off. Reduce the sensitivity by turning counterclockwise if the LED remains on.
- Finished: if set correctly, the LED changes between gap and label.

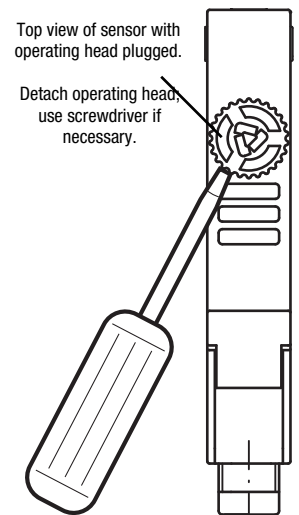

Short instructions for sensor adjustment via teach button for GS 61/... (with Teach)

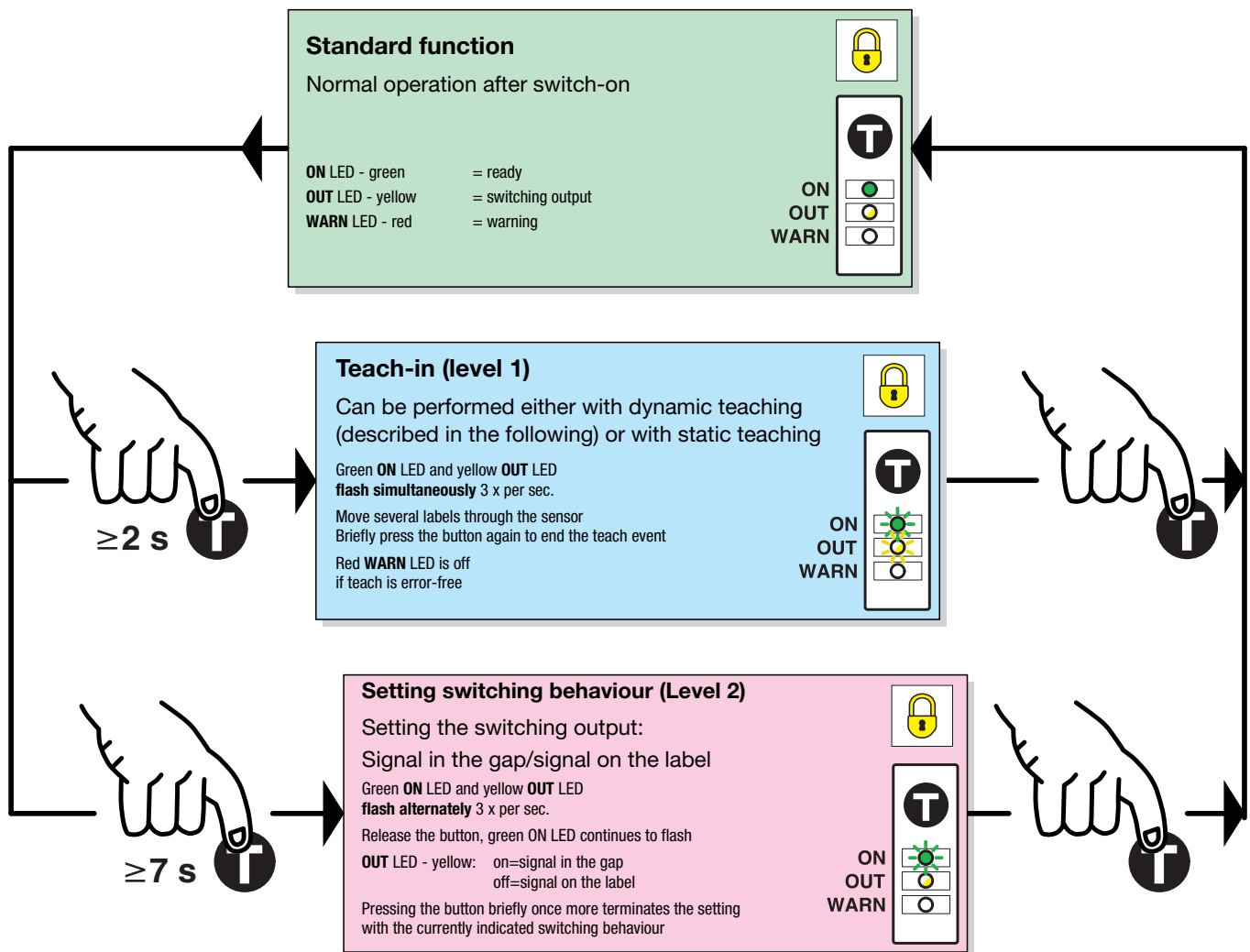

 = function lockable through constant application of U_B on the teach input (for devices with teach input only)

Standard function for GS 61/... (with Teach)

During operation the sensor is always in this function. The sensor detects label gaps with high precision and speed. This is indicated by the yellow LED and the switching output.

Indicators:

ON LED - green	Constantly ON when operating voltage is applied.
OUT LED - yellow	Indicates the switching signal. LED is ON if the sensor detects label gaps. The display is independent of the output setting.
WARN LED - red	Is OFF if operation is error-free. If the "Control limit reached" message appears or if the last teach event was faulty, the red LED illuminates.

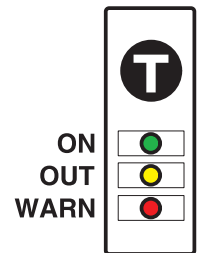

Operation

The teach button must be pressed for at least 2 seconds to operate the device. The button can be electrically disabled to prevent accidental operation.

Sensor adjustment (Teach-In) via teach button for GS 61/... (with Teach)

Manual teach while label tape is passing through (dynamic)

Preparation: Insert label tape into the sensor.

- Press the teach button until green and yellow LEDs flash simultaneously.
- Release teach button.
- During the teach event, the switching output is frozen in the most recently valid state prior to teaching.
- Advance the label tape at a maximum speed of 20m/min through the sensor so that at least 3 ... 7 labels pass through the sensor.
- Press the button briefly once more to terminate the teach event, the sensor goes into standard mode.

3 ... 7 label gaps should be advanced through the sensor in order to achieve stable switching points.

If the teach event is faulty (e.g. transmission with insufficiently thick base material), the red LED illuminates, the green and yellow LEDs flash rapidly. For error acknowledgment, briefly press the teach button and repeat the teach event. If the error cannot be rectified, the label material cannot be detected with the GS 61/... ..2...

Manual teach if the label tape cannot be advanced (static)

Preparation: Remove one or more labels from the base material and advance this blank area into the sensor.

- Press the teach button until green and yellow LEDs flash simultaneously.
- Release teach button.
- During the teach event, the switching output is frozen in the most recently valid state prior to teaching.
- Press the button briefly once more to terminate the teach event, the sensor goes into standard mode.

If the teach event is faulty (e.g. transmission with insufficiently thick base material), the red LED illuminates, the green and yellow LEDs flash rapidly. For error acknowledgment, briefly press the teach button and repeat the teach event. If the error cannot be rectified, the label material cannot be detected with the GS 61/... ..2...

Adjusting the switching behaviour of the switching output (signal in the label gap/on the label)

- Press the teach button until green and yellow LEDs flash alternately.
- Release the teach button - the green LED continues to flash, the yellow LED alternates slowly between ON and OFF.
- Yellow LED ON = output switches in the label gap
Yellow LED OFF = output switches on the label.
- If the button is pressed again while the LED is ON, the device switches in the label gap. For control purposes, the switching behaviour is displayed as long as the button is pressed. If the output is to switch on the label, the button must be pressed while the LED is OFF.
- Finished.

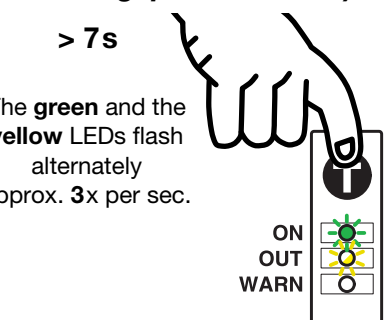
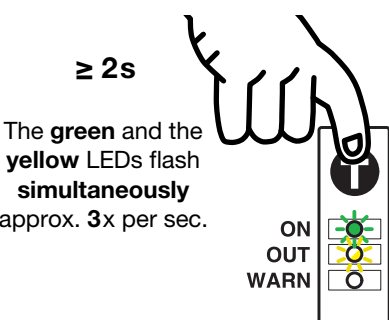
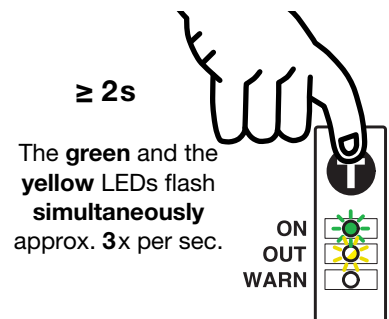

Sensor adjustment (Teach-In) via teach input for GS 61/... (with Teach)



The following description applies to PNP switching logic!

U_{Teach} not connected	Internal pull-down resistor pulls the input down to zero	Teach button can be operated; all functions adjustable
$U_{Teach\ low} \leq 2V$	Low level	Teach button can be operated; all functions adjustable
$U_{Teach\ high} \geq 8V$	High level	Teach button disabled; button has no function
$U_{Teach} > 2V \dots < 8V$	Not permitted	

The device setting is stored in a fail-safe way. A reconfiguration following voltage interruption or switch-off is thus not required.

Line teach while label tape is passing through

Preparation: Insert the label tape in the correct position in the sensor (align the middle of the tape to the sensor marking).

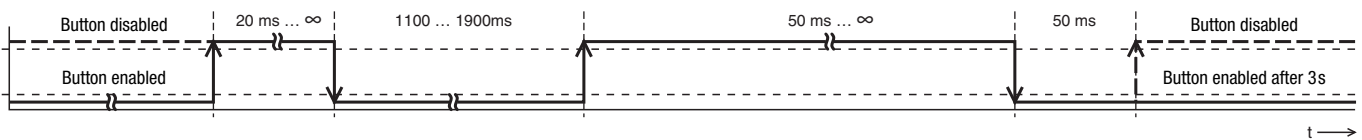

Pulse only necessary if a low-level was applied previously	Activation of the teach-in: Action starts with the falling edge: $t_{Teach} = 1100 \dots 1900ms$	The rising edge starts the teach event. The green and yellow LEDs flash alternately 3x per second as long as the signal is high. Advance the label tape so that several label gaps pass the sensor, thereby allowing the teach values to be determined.	The teach event is concluded with the falling edge. 50 ms after the falling edge, the sensor returns to normal operation. The teach button is enabled again after max. 3s.
--	--	--	--

The red LED lights if a teach error occurs (e.g. the label cannot be reliably detected due to insufficient signals).

Regardless of the state, the green LED is on when the teach event is terminated, the yellow LED indicates the current switching state.

Line teach if the label tape cannot be advanced (static teaching)

Preparation: Remove one or more labels from the base material and place this blank area in the sensor. The label tape must now not be advanced further.

The process is identical to the line teach with moving label tape.

Adjusting the switching behavior of the switching output – light/dark switching

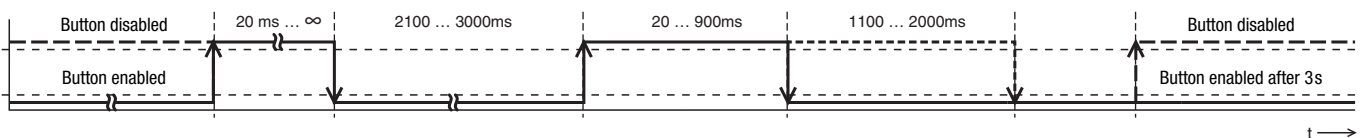

Pulse only necessary if a low-level was applied previously	Activation of the teach switching output: Action starts with the falling edge: $t_{Teach} = 2100 \dots 3000ms$	Switching output switches in the label gap (20 ... 900ms) Switching output switches on the label (1100 ... 2000ms)	The teach event is concluded with the falling edge. 50 ms after the falling edge, the sensor returns to normal operation. The teach button is enabled again after max. 3s.
--	--	---	--

Locking the teach button via the teach input



GS 61/... (with Teach)

A **static high signal** on the teach input locks the teach button on the device so that no manual operation is possible (e.g. protection against erroneous operation or manipulation).

If the teach input is not connected or if there is a static low signal, the button is enabled and can be operated freely.

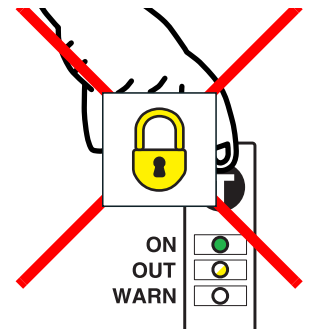

Notices for integrating the sensor in a control concept

If the sensor is taught externally via a control, it may be necessary to receive acknowledgment from the sensor with respect to its current teach state. Use the following chart for this purpose:

Operating mode	Reaction from sensor
Dispensing mode	Dynamic output signal: alternates between gap and label
Teach	Static output signal: the state prior to teaching is frozen
Teach OK	Output signal is dynamic again
Teach faulty	Output signal is dynamic again - repeat teach event if necessary

Mounting with mounting device BT-GS6X or BT-GS6X.L

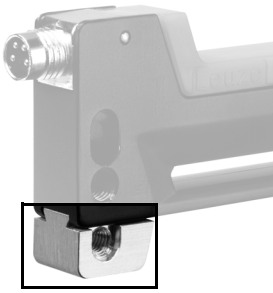

The BT-GS6X or BT-GS6X.L are necessary if mounting compatibility with the GS 06 forked photoelectric sensor is desired. When using, ensure secure seating (tighten set screw).

Maintenance information

The GS 61 forked photoelectric sensor is largely maintenance free. Depending on the environmental conditions and the used materials, it may be necessary from time to time to clean the transparent parts in the lower and upper fork of the forked photoelectric sensor. We recommend using a soft, moist cloth for this purpose. To protect the surface, cleaning agents containing solvents should not be used for transparent parts.

Environmental durability

The used materials feature very good resistance to weak acids and bases as well as to UV exposure. Contact with organic solvents is possible only to a limited extent and only for short times. Resistance to chemicals and oils must be determined on a case-by-case basis.