

**TURCK**

**Industrial  
Automation**

**ENCODERS**

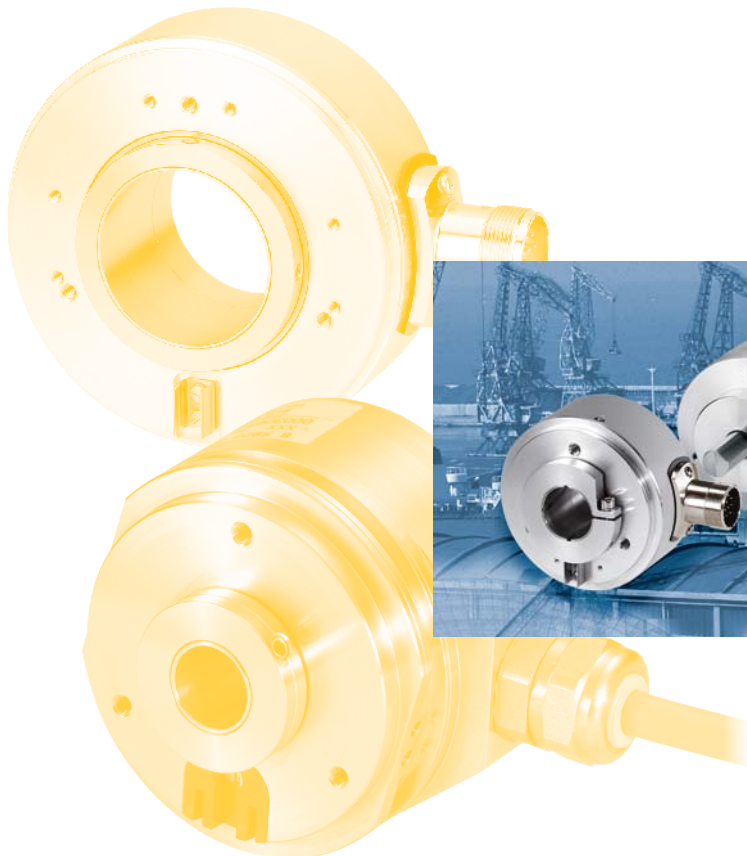

***Sense it! Connect it! Bus it! Solve it!***

# Incremental encoders



Incremental encoders use electrical pulses to measure rotation speed or position.

The dual-channel incremental encoders of the Ri series, detect positions bidirectionally as well as the rotation sense of the shaft.

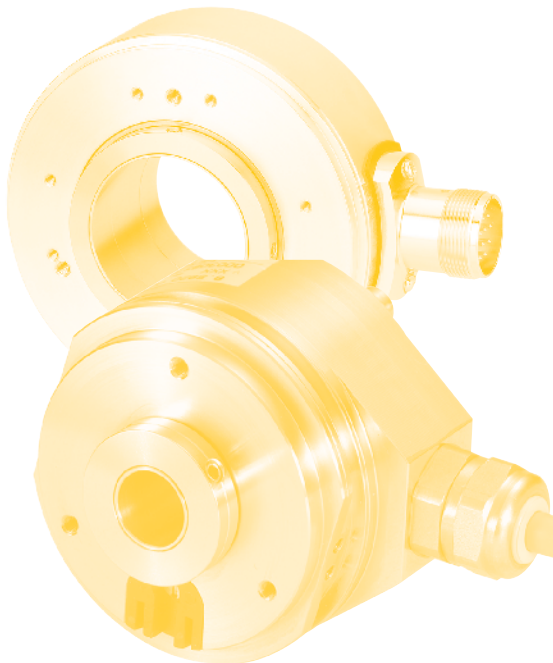

Design	Shaft diameter flange/ mounting	Electrical connection/ operating voltage	Resolution imp.	Type code	
<b>Compact</b> Ø 37 mm	<b>Solid shaft</b>				
	6 mm without flange	Cable connection $U_B = 5 \dots 30$ VDC	360 500 512 1000 1024	Ri-08S6S-2F360-C 1M Ri-08S6S-2F500-C 1M Ri-08S6S-2F512-C 1M Ri-08S6S-2F1000-C 1M Ri-08S6S-2F1024-C 1M	
	<b>Hollow shaft</b>				
	8 mm stator coupling	Cable connection $U_B = 5 \dots 30$ VDC	360	Ri-09H8E-2F360-C 1M	
<b>Standard</b> Ø 58 mm	<b>Solid shaft</b>				
	6 mm clamping flange	Cable connection $U_B = 10 \dots 30$ VDC	360 2048 2500 4096 5000	Ri-10S6C-2B360-H1181 Ri-10S6C-2B2048-H1181 Ri-10S6C-2B2500-H1181 Ri-10S6C-2B4096-H1181 Ri-10S6C-2B5000-H1181	
	10 mm clamping flange	Cable connection $U_B = 10 \dots 30$ VDC	360 2048 2500 4096 5000	Ri-10S10C-2B360-H1181 Ri-10S10C-2B2048-H1181 Ri-10S10C-2B2500-H1181 Ri-10S10C-2B4096-H1181 Ri-10S10C-2B5000-H1181	
	6 mm synchro flange	Cable connection $U_B = 10 \dots 30$ VDC	360 2048 2500 4096 5000	Ri-10S6S-2B360-H1181 Ri-10S6S-2B2048-H1181 Ri-10S6S-2B2500-H1181 Ri-10S6S-2B4096-H1181 Ri-10S6S-2B5000-H1181	
	10 mm synchro flange	Cable connection $U_B = 10 \dots 30$ VDC	360 2048 2500 4096 5000	Ri-10S10S-2B360-H1181 Ri-10S10S-2B2048-H1181 Ri-10S10S-2B2500-H1181 Ri-10S10S-2B4096-H1181 Ri-10S10S-2B5000-H1181	
	<b>Hollow shaft</b>				
	10 mm torque stop	M12 male $U_B = 10 \dots 30$ VDC	360 2048 2500 4096 5000	Ri-12H10T-2B360-H1181 Ri-12H10T-2B2048-H1181 Ri-12H10T-2B2500-H1181 Ri-12H10T-2B4096-H1181 Ri-12H10T-2B5000-H1181	
	15 mm torque stop	M12 male $U_B = 10 \dots 30$ VDC	360 2048 2500 4096 5000	Ri-12H15T-2B360-H1181 Ri-12H15T-2B2048-H1181 Ri-12H15T-2B2500-H1181 Ri-12H15T-2B4096-H1181 Ri-12H15T-2B5000-H1181	
	<b>Large hollow shaft</b> Ø 100 mm	25 mm spring element long	M23 male $U_B = 10 \dots 30$ VDC	1024 2048 5000	Ri-42H25S4-2B1024-12M23 Ri-42H25S4-2B2048-12M23 Ri-42H25S4-2B5000-12M23
		30 mm spring element long	M23 male $U_B = 10 \dots 30$ VDC	1024 2048 5000	Ri-42H30S4-2B1024-12M23 Ri-42H30S4-2B2048-12M23 Ri-42H30S4-2B5000-12M23

Incremental – push-pull with inversion

## High protection class

A protection rating of as high as IP69K can be achieved, even under the most adverse application conditions, thanks to the excellently protected shaft seal. The devices always work safely and reliably, even in the roughest environments.



## Short delivery terms

We deliver up to 5 encoders within 10 days from the standard product portfolio listed here, provided they are available on stock.

# Absolute singleturn encoders

**TURCK**

Industrial  
Automation



Absolute singleturn encoders detect any angle within a full revolution of 360°. With absolute encoders, each incremental angle is assigned a code pattern. This allows the position to be detected at any time, even after a power failure, without having to initialize a reference run. Absolute encoders detect angles, positions and inclinations precisely – tasks, that are typically found in robotics, positioning and process technology.

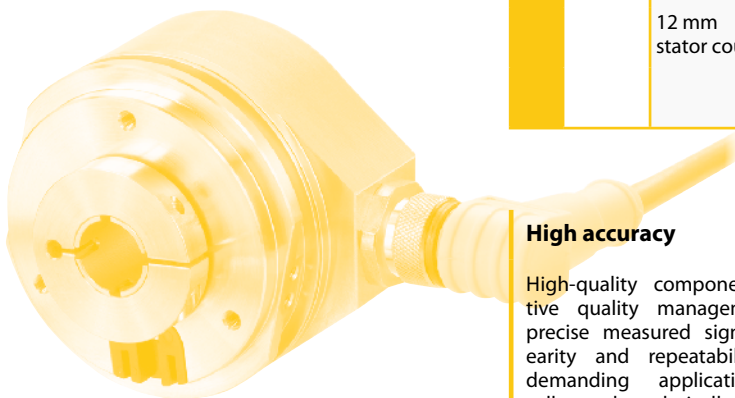

Design	Shaft diameter flange/ mounting	Electrical connection/ operating voltage	Output type/ resolution	Type code
<b>Compact Ø 36 mm</b>	<b>Solid shaft</b>			
	6 mm synchro flange	Cable connection $U_B = 15...30$ VDC	Analog, U, 0...10 V, 12 bit	RS-06S6S-8B12B-C 1M
		Cable connection $U_B = 10...30$ VDC	Analog, I, 4...20 mA, 12 bit	RS-06S6S-7A12B-C 1M
		Cable connection $U_B = 5...30$ VDC	SSI, binary 9 bit	RS-54S6S-5B9B-C 1M
	<b>Hollow shaft</b>			
	6 mm stator coupling	Cable connection $U_B = 15...30$ VDC	Analog, U, 0...10 V, 12 bit	RS-07H6E-8B12B-C 1M
Cable connection $U_B = 10...30$ VDC		Analog, I, 4...20 mA, 12 bit	RS-07H6E-7A12B-C1M	
Cable connection $U_B = 5...30$ VDC		SSI, binary 9 bit	RS-55H6E-5B9B-C 1M	
<b>Singleturn</b>	<b>Solid shaft</b>			
	6 mm clamping flange	M12 male $U_B = 10...30$ VDC	SSI Gray 13 bit	RS-24S6C-3C13B-H1181
		M12 male $U_B = 10...30$ VDC	PROFIBUS 16 bit	RS-25S6C-9A16B-R3M12
	10 mm clamping flange	M12 male $U_B = 10...30$ VDC	SSI, Gray 13 bit	RS-24S10C-3C13B-H1181
		M12 male $U_B = 10...30$ VDC	PROFIBUS 16 bit	RS-25S10C-9A16B-R3M12
	6 mm synchro flange	M12 male $U_B = 10...30$ VDC	SSI, Gray 13 bit	RS-24S6S-3C13B-H1181
		M12 male $U_B = 10...30$ VDC	PROFIBUS 16 bit	RS-25S6S-9A16B-R3M12
	10 mm synchro flange	M12 male $U_B = 10...30$ VDC	SSI, Gray 13 bit	RS-24S10S-3C13B-H1181
		M12 male $U_B = 10...30$ VDC	PROFIBUS 16 bit	RS-25S10S-9A16B-R3M12
	<b>Hollow shaft</b>			
	12 mm stator coupling	M12 male $U_B = 10...30$ VDC	SSI, Gray 13 bit	RS-31H12E-3C13B-H1181
		M12 male $U_B = 10...30$ VDC	PROFIBUS 16 bit	RS-33B12E-9A16B-R3M12

## High accuracy

High-quality components and an innovative quality management provide highly precise measured signals for excellent linearity and repeatability. Even the most demanding applications are economically and technically viable with TURCK encoders.



# Absolute multiturn encoders

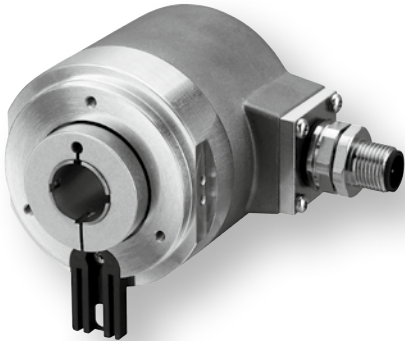

Absolute multiturn encoders detect any angle within a full revolution of 360° and also the number of revolutions. With absolute encoders, each incremental angle is assigned a code pattern. This allows the position to be detected at any time, even after a power failure, without having to initialize a reference run. Absolute encoders detect angles, positions and inclinations precisely – tasks, that are typically found in robotics, positioning and process technology.

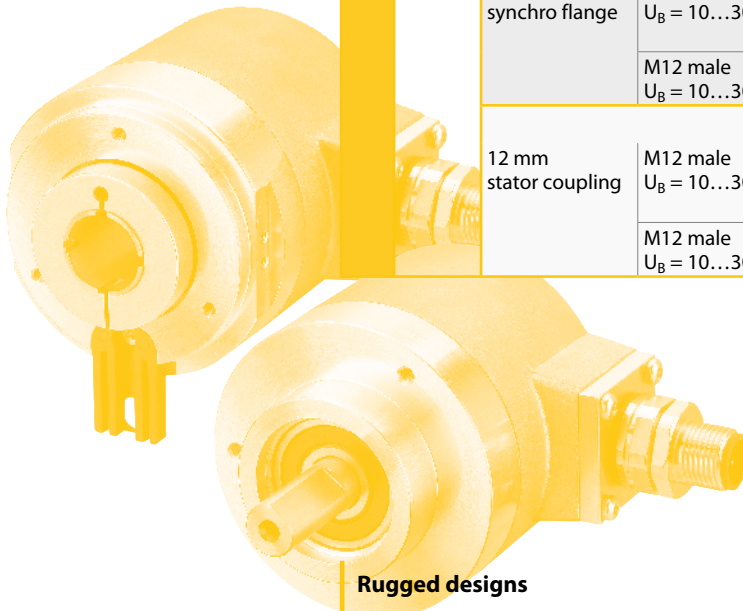

## Rugged designs

Balanced stainless steel clamp rings and highly rugged bearing-shaft constructions improve the stability and reliability of the devices, making them resistant to extremely heavy mechanical impacts. Thanks to the new design, the encoders are made for heavy duty applications and highest revolution speeds.



Design	Shaft diameter flange/ mounting	Electrical connection/ operating voltage	Output type/ resolution	Type code	
Compact Ø 36 mm	<b>Solid shaft</b>				
	8 mm synchro flange	Cable connection U <sub>B</sub> = 10...30 VDC	SSI, Gray 12/12 bit	RM-46S8S-3C24B-CT 1M	
	<b>Hollow shaft</b>				
	10 mm stator coupling	Cable connection U <sub>B</sub> = 10...30 VDC	SSI, Gray 12/12 bit	RM-50H10E-3C24B-CT 1M	
Multiturn	<b>Solid shaft</b>				
	6 mm clamping flange	M12 male U <sub>B</sub> = 10...30 VDC	SSI, Gray 13/12 bit	RM-28S6C-3C25B-H1181	
		M12 male U <sub>B</sub> = 10...30 VDC	PROFIBUS 16/12 bit	RM-29S6C-9A28B-R3M12	
	10 mm clamping flange	M12 male U <sub>B</sub> = 10...30 VDC	SSI, Gray 13/12 bit	RM-28S10C-3C25B-H1181	
		M12 male U <sub>B</sub> = 10...30 VDC	PROFIBUS 16/12 bit	RM-29S10C-9A28B-R3M12	
	6 mm synchro flange	M12 male U <sub>B</sub> = 10...30 VDC	SSI, Gray 13/12 bit	RM-28S6S-3C25B-H1181	
		M12 male U <sub>B</sub> = 10...30 VDC	PROFIBUS 16/12 bit	RM-29S6S-9A28B-R3M12	
	10 mm synchro flange	M12 male U <sub>B</sub> = 10...30 VDC	SSI, Gray 13/12 bit	RM-28S10S-3C25B-H1181	
		M12 male U <sub>B</sub> = 10...30 VDC	PROFIBUS 16/12 bit	RM-29S10S-9A28B-R3M12	
		<b>Hollow shaft</b>			
		12 mm stator coupling	M12 male U <sub>B</sub> = 10...30 VDC	SSI, Gray 13/12 bit	RM-35H12E-3C25B-H1181
			M12 male U <sub>B</sub> = 10...30 VDC	PROFIBUS 16/12 bit	RM-36B12E-9A28B-R3M12



Encoders with a prefixed draw-wire sensor (0.25 to 40 m long) are the best choice for direct length measurements. Thanks to the excellent repeatability rating of 0.05 mm, they solve position control tasks with the utmost precision in applications which, up to now, could only be handled by complex equipment.

Whether used for positioning of pumps in tanks, for alignment of elevating platforms or orientation of cranes: Just select a draw-wire sensor of the right size and with the appropriate output configuration for your system.

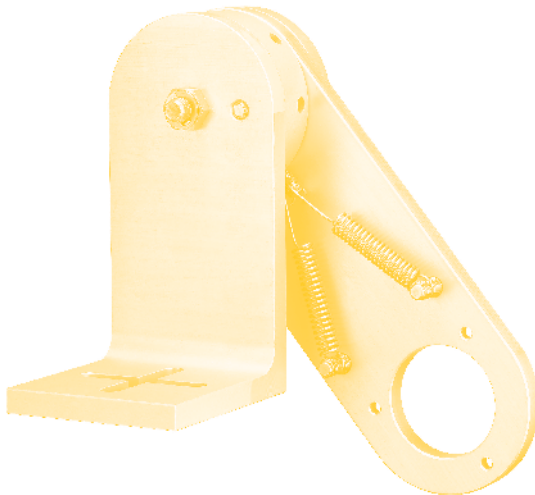

Draw-wire sensors	Technical data	Measuring range	Type code	
	Analog current output, 4...20 mA, 2-wire, $U_B = 12...30$ VDC, M12-male		250 mm	DW250-70-7E-H1141
		500 mm	DW500-70-7E-H1141	
		1000 mm	DW1000-110-7E-H1141	
		2000 mm	DW2000-110-7E-H1141	
		3000 mm	DW3000-110-7E-H1141	
		6000 mm	DW6000-155-7E-H1141	
		10000 mm	DW10000-135-7E-H1141	
		15000 mm	DW15000-135-7E-H1141	
		20000 mm	DW20000-135-7E-H1141	
		30000 mm	DW30000-135-7E-H1141	
		40000 mm	DW40000-135-7E-H1141	
Potentiometer output, 1 k $\Omega$ , $U_B = \text{max. } 30$ VDC, M12 male			250 mm	DW250-70-PA-H1141
			500 mm	DW500-70-PA-H1141
			1000 mm	DW1000-110-PA-H1141
		2000 mm	DW2000-110-PA-H1141	
		3000 mm	DW3000-110-PA-H1141	
		6000 mm	DW6000-155-PA-H1141	
		10000 mm	DW10000-135-PA-H1141	
		15000 mm	DW15000-135-PA-H1141	
		20000 mm	DW20000-135-PA-H1141	
		30000 mm	DW30000-135-PA-H1141	
	40000 mm	DW40000-135-PA-H1141		

### High interference immunity

Frequency converters, large motors, ferritic metals or permanent magnets are no problem at all: The optically operating encoders are insensitive to magnetic fields of all kinds and feature excellent EMC properties.



# Measuring wheels



If simple length measurements are required, such as cutting paper or fabrics to length, encoders with a prefixed measuring wheel are the inexpensive but very precisely operating alternative.

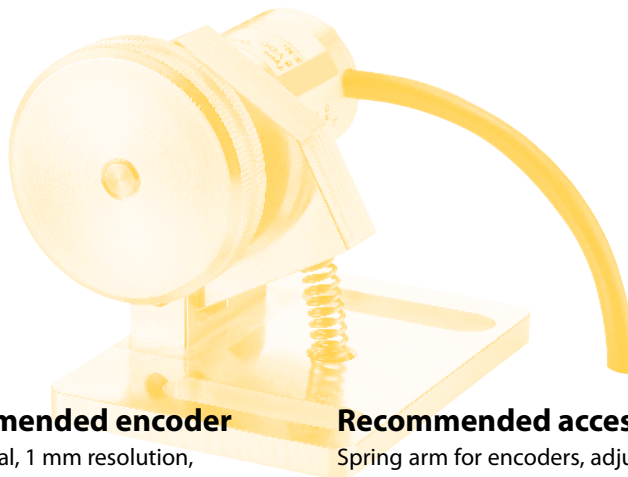

## Recommended encoder

Incremental, 1 mm resolution,  
Type: RI-10S10C-2B500-H1181

## Recommended accessory

Spring arm for encoders, adjustable contact pressure, multiple mounting possibilities. Type: RMW-1

	Material surface	Perimeter/width	Material	Coating	Operating temperature	Bore for encoder shaft	Type code
<b>Measuring wheel</b>	Cardboard Wood Fabric	0.5 m/25 mm	Aluminium	Cross-knurl	–	10 mm	RMW-5
	Cardboard Wood Fabric Paper		Plastic	Hytrel (smooth)	-10...+50 °C		RMW-6
	Cardboard Wood Fabric Paper Wire		Aluminium	Vulkollan (smooth)	-30...+80 °C		RMW-7
	Fabric Metal Coated surface		Aluminium	Burled rubber	-30...+80 °C		RMW-8
	Fabric		Plastic	Hytrel (grooved)	-30...+80 °C		RMW-9

## Shock and vibration proof

The extremely rugged bearing assembly guarantees high stability of the shaft in case of vibration and other mechanical loads. Blocked bearings, enough spacing between the bearings and extra strong outer bearings prevent interferences and machine downtimes emerging from intense load. These are strains which mechanically complex applications are often exposed to.



Accessories for solid shaft encoders	Accessories	Max. revolution [Ncm]	Max. axial offset [mm]	Max. angular error [°]	Bore Ø/mm (for shaft Ø) 10/10	Type code	
	Bellows coupling Ø 19 mm	150	± 0.7	± 1.5			RCS-1
	Spring coupling Ø 30 mm	80	± 0.4	± 3			RCS-11
	PAGUFLEX® coupling	3	15	15			RCS-7

Accessories for hollow shaft encoders	Accessories	Conditions	For encoders	Reference diameter	Type code	
	Mounting plate, short	Axial/radial play low dynamics	Ri-12 RS-31 RS-33 RM-35 RM-36	64.5 mm		RME-9
	Mounting plate, long	Axial/radial play low dynamics	Ri-12 RS-31 RS-33 RM-35 RM-36	80...170 mm		RME-4
	Stator coupling	Axial/radial play high dynamics	Ri-12 RS-31 RS-33 RM-35 RM-36	65 mm		RME-7
	Spring element, long	High axial play	Ri-42	110 mm		RME-10
	Insulating inlay for shaft	Reduction/insulation of shaft diameter	Ri-12H15T	Internal diameter d1 = 6 mm		RSA-1 RSA-5
	Deflection roller					RDR-1

**TURCK**

**Industrial  
Automation**

**www.turck.com**



To get all product information, just scan the QR code with a smart-phone or webcam.

**Hans Turck GmbH & Co. KG**  
Witzlebenstraße 7  
45472 Mülheim an der Ruhr  
Germany  
Tel. +49 208 4952-0  
Fax +49 208 4952-264  
E-Mail [more@turck.com](mailto:more@turck.com)  
Internet [www.turck.com](http://www.turck.com)

D101885 2013/01

