

General Technical

T

Contents

S

Size

Overview.....	T4
Recommended Flow Diameter — In Inches	T5
Recommended Flow Diameter — In Millimeters	T6
Tube Fittings Pressure Drop	T7-T8

T

Temperature

Overview.....	T9
O-Ring Material Selection	T10

A

Application

Overview.....	T11
Tube/Hose End Summary.....	T12
Port End Summary	T13
Tube to Port Pairing	T14
Conformance to Application Specification and Approvals.....	T15

M

Media

Fluid Compatibility, Protective Coatings On Steel, Choosing Tube Material and Type.....	T16-T17
Corrosion of Base Metals In Contact.....	T18
O-Ring Material Selection	T19-T22
Tube and Fitting Material Compatibility	T23

P

Pressure

Fitting and Adapter Pressure Ratings	T24
Inch Tube Pressure Ratings	T25-T26
Metric Tube Pressure Ratings	T27
Tube Selection Example	T28

How To Order (TFD Standard Nomenclature Construction)

Seal-Lok, Triple-Lok, Ferulok, Intru-Lok, JIS and K4.....	T29
4-Bolt Hydraulic Flanges.....	T30
EO and EO-2 Fittings and Accessories	T31

Port Details

ISO 6149-1	T32
SAE J1926-1	T33
SAE Straight Thread Connector Use in MS33649	T34
ISO 6162	T35
ISO 1179-1	T36
ISO 9974-1	T37
NPTF and BSPT	T38-T39

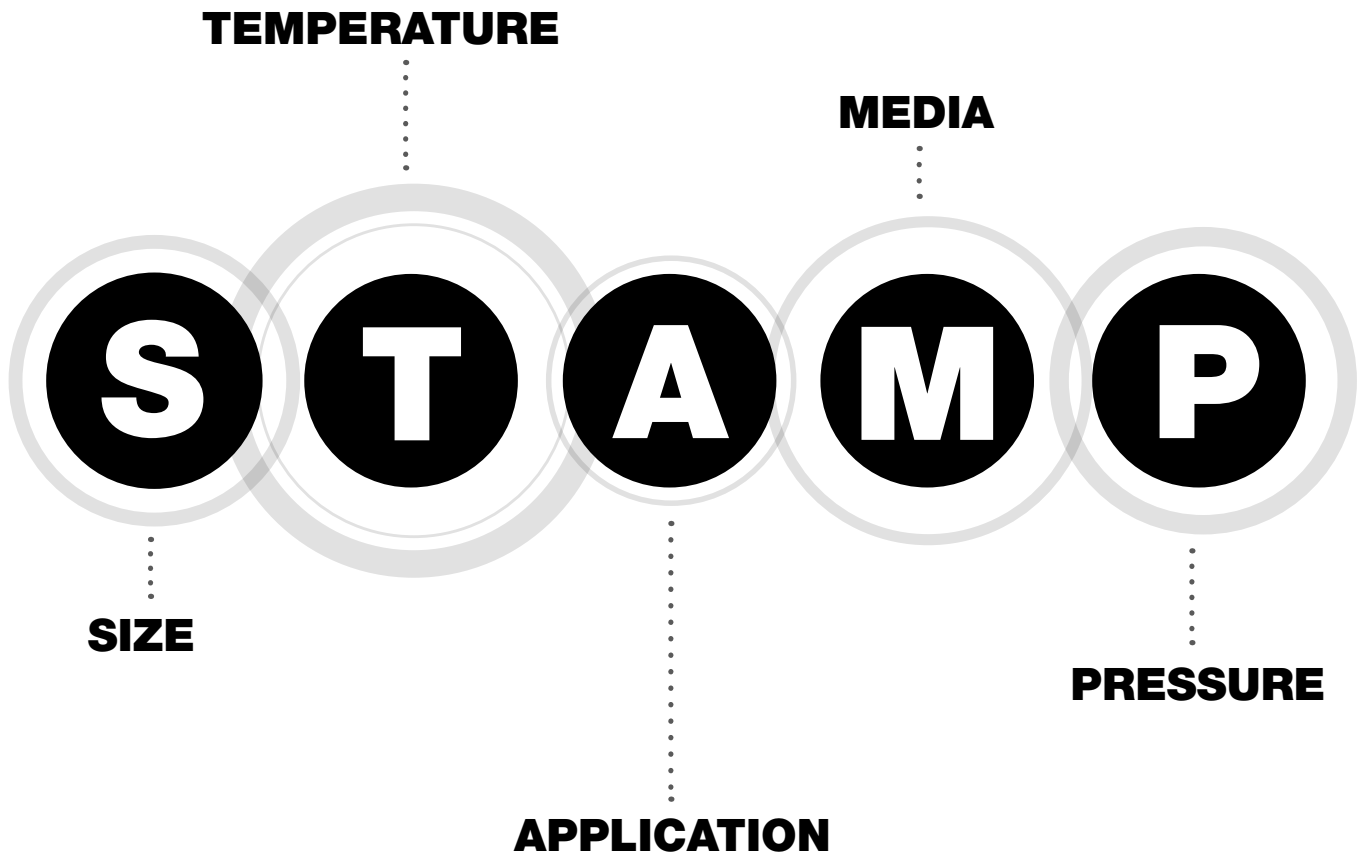

Before you spec it STAMP it.

When you order fittings and adapters from Parker, remember the word “STAMP.” That way you won’t forget important information! Size, Temperature, Application, Media and Pressure “STAMP” is the process for determining the proper fitting or adaptor selection. Selecting the proper fitting for a given application is an important part of system design.



Size



Proper material, type and size of tubing and fittings for a given application is critical for efficient and trouble free operation of the fluid system. Selection of proper tubing and fittings involves determining the correct flow diameter, then selecting the correct material and the optimum tube size (O.D. and wall thickness).

Proper sizing for various parts of a hydraulic system results in an optimum combination of efficient and cost effective performance. A tube or fitting that is too small causes high fluid velocity, which has many detrimental effects. In suction lines, it causes cavitation which starves and damages pumps. In pressure lines, it causes high friction losses and turbulence, both resulting in high pressure drops and heat generation. High heat accelerates wear in moving parts and rapid aging of seals and hoses, all resulting in reduced component life. High heat generation also means wasted energy, and hence, low efficiency.

Too large of a tube or fitting increases system cost. Thus, optimum sizing is very critical. The following is a simple procedure for sizing of tube and fittings.

Step 1: Determine Required Flow Diameter

Use Tables T1 and T2 to determine recommended flow diameter for the required flow rate and type of line.

The table is based on the following recommended flow velocities:

Pressure lines — 25 ft./sec. or 7.62 meters/sec.

Return lines — 10 ft./sec. or 3.05 meters/sec.

Suction lines — 4 ft./sec. or 1.22 meters/sec.

If you desire to use different velocities than the above, use one of the following formulae to determine the required flow diameter.

Tube I.D. (in.) = 0.64	$\frac{\text{Flow in GPM}}{\text{Velocity in ft./sec.}}$
OR	
Tube I.D. (in.) = 4.61	$\frac{\text{Flow in liters per minute}}{\text{Velocity in meters/sec.}}$

The flow diameter will be used in combination with the temperature, application, media and pressure data to determine the proper tube size (O.D. and wall thickness).

NOTE: The tube fitting dash (-) size will be dependent on the tube outside diameter selected based on the S.T.A.M.P. criteria.

Recommended Flow Diameter – In Inches 

Maximum Flow Rate GPM	Recommended Flow Diameter in Inches		
	Pressure Lines	Return Lines	Suction Lines
0.25	0.064	0.101	0.160
0.50	0.091	0.143	0.226
0.75	0.111	0.175	0.277
1.00	0.128	0.202	0.320
1.25	0.143	0.226	0.358
1.50	0.157	0.247	0.392
1.75	0.169	0.267	0.423
2.00	0.181	0.286	0.453
2.50	0.202	0.319	0.506
3.00	0.222	0.350	0.554
3.50	0.239	0.378	0.599
4.00	0.256	0.404	0.640
4.50	0.272	0.429	0.679
5.00	0.286	0.452	0.716
5.50	0.300	0.474	0.750
6.00	0.314	0.495	0.784
6.50	0.326	0.515	0.816
7.00	0.339	0.534	0.847
7.50	0.351	0.553	0.876
8.00	0.362	0.571	0.905
8.50	0.373	0.589	0.933
9.00	0.384	0.606	0.960
9.50	0.395	0.623	0.986
10.00	0.405	0.639	1.012
11.00	0.425	0.670	1.061
12.00	0.443	0.700	1.109
13.00	0.462	0.728	1.154
14.00	0.479	0.756	1.197
15.00	0.496	0.782	1.239
16.00	0.512	0.808	1.280
17.00	0.528	0.833	1.319
18.00	0.543	0.857	1.358
19.00	0.558	0.880	1.395
20.00	0.572	0.903	1.431
22.00	0.600	0.947	1.501
24.00	0.627	0.990	1.568
26.00	0.653	1.030	1.632
28.00	0.677	1.069	1.693
30.00	0.701	1.106	1.753
32.00	0.724	1.143	1.810
34.00	0.746	1.178	1.866
36.00	0.768	1.212	1.920
38.00	0.789	1.245	1.973
40.00	0.810	1.278	2.024
42.00	0.830	1.309	2.074
44.00	0.849	1.340	2.123
46.00	0.868	1.370	2.170
48.00	0.887	1.399	2.217
50.00	0.905	1.428	2.263
55.00	0.949	1.498	2.373
60.00	0.991	1.565	2.479

Maximum Flow Rate GPM	Recommended Flow Diameter in Inches		
	Pressure Lines	Return Lines	Suction Lines
65.00	1.032	1.629	2.580
70.00	1.071	1.690	2.677
75.00	1.109	1.749	2.771
80.00	1.145	1.807	2.862
85.00	1.180	1.862	2.950
90.00	1.214	1.916	3.036
95.00	1.248	1.969	3.119
100.00	1.280	2.020	3.200
110.00	1.342	2.119	3.356
120.00	1.402	2.213	3.505
130.00	1.459	2.303	3.649
140.00	1.515	2.390	3.786
150.00	1.568	2.474	3.919
160.00	1.619	2.555	4.048
170.00	1.669	2.634	4.172
180.00	1.717	2.710	4.293
190.00	1.764	2.784	4.411
200.00	1.810	2.857	4.525

Table T1 – Recommended Flow Diameters, in Inches

Dimensions and pressures for reference only, subject to change.



Recommended Flow Diameter – In Millimeters

Maximum Flow Rate LPM*	Recommended Flow Diameter in Millimeters		
	Pressure Lines	Return Lines	Suction Lines
1	1.670	2.640	4.180
2	2.362	3.734	5.911
3	2.893	4.573	7.240
4	3.340	5.280	8.360
5	3.734	5.903	9.347
6	4.091	6.467	10.239
7	4.418	6.985	11.059
8	4.723	7.467	11.823
9	5.010	7.920	12.540
10	5.281	8.348	13.218
12	5.785	9.145	14.480
14	6.249	9.878	15.640
16	6.680	10.560	16.720
18	7.085	11.201	17.734
20	7.468	11.806	18.694
22	7.833	12.383	19.606
24	8.181	12.933	20.478
26	8.515	13.461	21.314
28	8.837	13.970	22.118
30	9.147	14.460	22.895
32	9.447	14.934	23.646
34	9.738	15.394	24.373
36	10.020	15.840	25.080
38	10.295	16.274	25.767
40	10.562	16.697	26.437
45	11.203	17.710	28.040
50	11.809	18.668	29.557
55	12.385	19.579	31.000
60	12.936	20.449	32.378
65	13.464	21.284	33.700
70	13.972	22.088	34.972
75	14.463	22.863	36.200
80	14.937	23.613	37.387
85	15.397	24.340	38.538
90	15.843	25.045	39.655
95	16.277	25.732	40.742
100	16.700	26.400	41.800
110	17.515	27.689	43.840
120	18.294	28.920	45.790
130	19.041	30.101	47.659
140	19.760	31.237	49.458
150	20.453	32.333	51.194
160	21.124	33.394	52.873
170	21.774	34.421	54.501
180	22.405	35.419	56.081
190	23.019	36.390	57.617
200	23.617	37.335	59.114
220	24.770	39.158	61.999
240	25.872	40.899	64.756
260	26.928	42.569	67.400
280	27.944	44.176	69.945

Maximum Flow Rate LPM*	Recommended Flow Diameter in Millimeters		
	Pressure Lines	Return Lines	Suction Lines
300	28.925	45.726	72.400
320	29.874	47.226	74.774
340	30.793	48.679	77.075
360	31.686	50.090	79.310
380	32.554	51.463	81.483
400	33.400	52.800	83.600
450	35.426	56.003	88.671
500	37.342	59.032	93.468
550	39.165	61.913	98.030
600	40.906	64.667	102.389
650	42.577	67.307	106.570
700	44.184	69.848	110.592
750	45.735	72.299	114.474
800	47.235	74.670	118.228

Table T2 – Recommended Flow Diameters, in Millimeters

*LPM = Liters Per Minute

Dimensions and pressures for reference only, subject to change.



Tube Fittings Pressure Drop..... **S**

In hydraulic systems, pressure drop represents loss of energy and therefore should be kept to a minimum. Pressure loss in straight tubing and hose is mainly caused by the frictional resistance of the walls, while in fittings it is mainly caused by changes in the magnitude or direction of the fluid velocity. Mathematical analysis of pressure drop, even though possible, may not be exact because of the interrelationship of factors such as fluid density, velocity, flow area and frictional coefficients.

The following pressure drop charts were derived from actual test data and may be used as a guide for determining pressure

drops at various flow rates through fittings for fluid indicated. To determine pressure drop for a given flow, trace a vertical line up from the flow axis to the desired size line then trace a horizontal line from this intersection over to the pressure drop axis.

Example: A size 8 CTX, with oil, similar to the test fluid, flowing through it at 4 gallons per minute, would cause a pressure drop of approximately 2.3 psi. Conversions will have to be made for fluids which are not similar to test fluid.

The Tube Fittings part numbers are listed below the Pressure Drop Chart to which they apply.

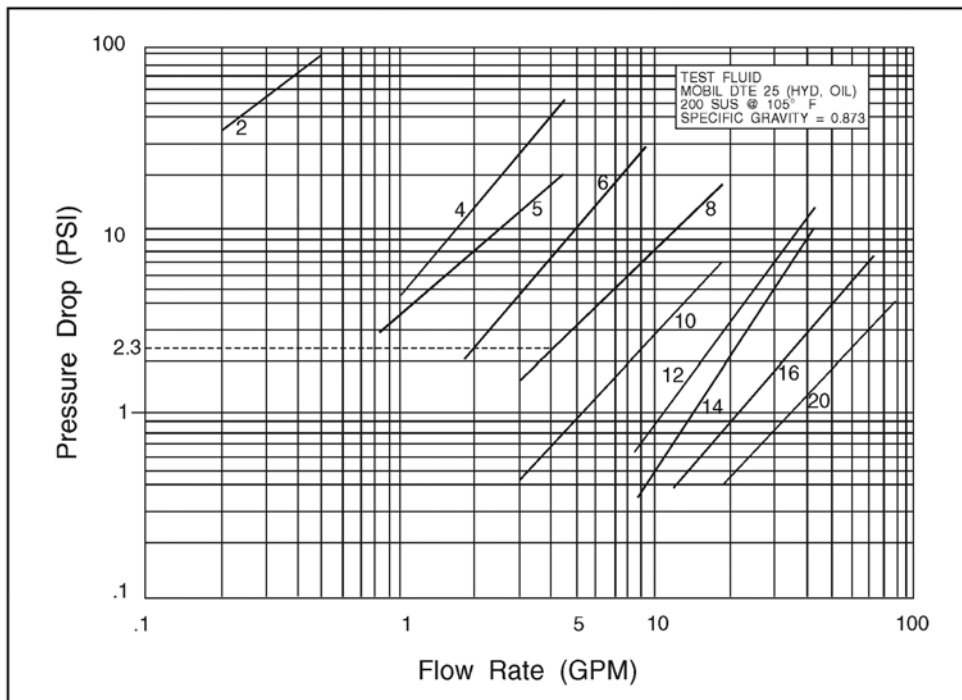

Examples:

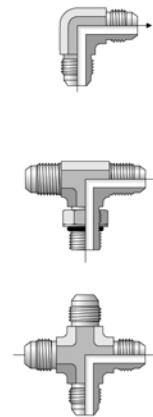

Fig. T3 – Pressure Drop Chart for 90° Fittings or Branch Path Through a Tee or Cross Fitting (Triple-Lok)

Pressure Drops for Other Fitting:

*These pressure drop curves were established with Triple-Lok fittings. The pressure drop values can be adjusted for other fittings of the same size by multiplying the value from the chart by the ratio of Triple-Lok flow diameter to that of the other fitting, raised to the 4th power.

Example: Find pressure drop for 6 C5L at 5 gallons per minute flow rate:

From the chart, the pressure drop for 6 C5X is 10 psi.
 Also, the ratio of 6 C5X to 6 C5L flow diameters is 0.297/0.264, or 1.125.
 Therefore, the pressure drop for Seal-Lok = 10 x (1.125)⁴ = 16 psi.

Pressure Drops for Other Fluids:

Pressure drop through a fitting is mainly caused by change in direction and velocity of the fluid. Therefore, it is directly proportional to the specific gravity of the fluid. The drop due to friction, which is dependent on the viscosity of the fluid, is so small in this case that it can be ignored. Thus, the pressure drop with a different fluid can be calculated by multiplying the value from the graph above by the ratio of specific gravity of the two fluids, or:

$$\text{New Drop} = \text{Value from the graph} \times \frac{\text{Specific Gravity of New Fluid}}{\text{Specific Gravity of Test Fluid (0.873)}}$$

Dimensions and pressures for reference only, subject to change.

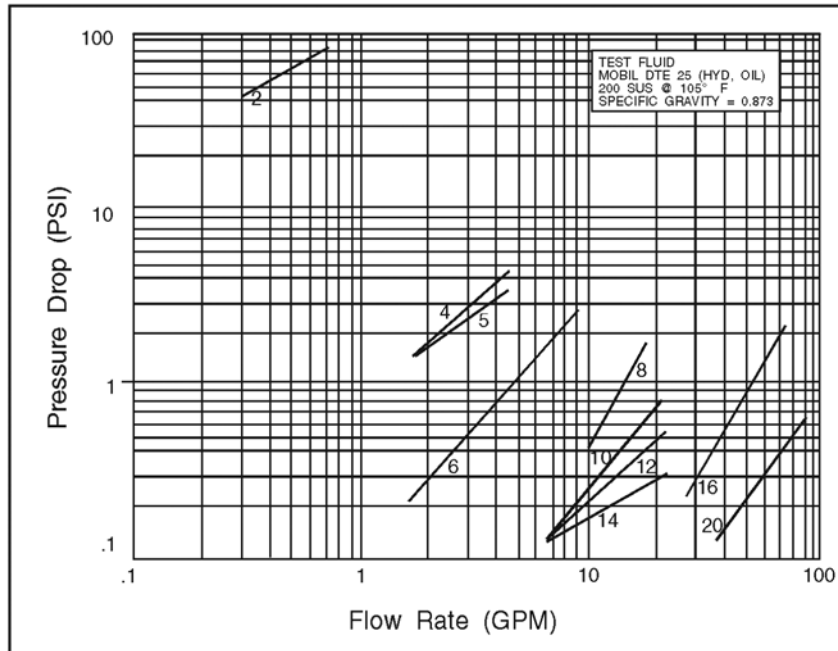

Examples:

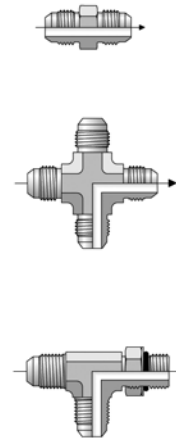
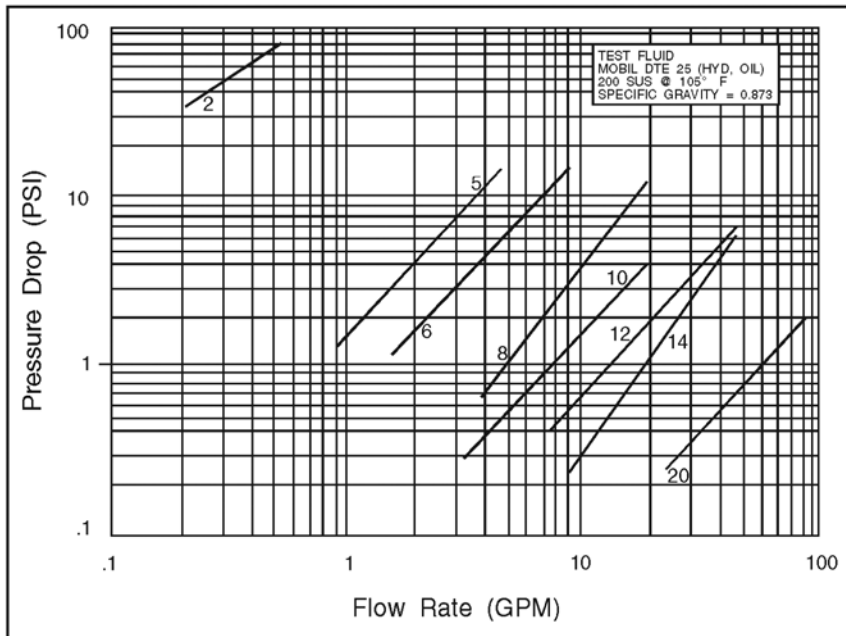

Fig. T4 – Pressure Drop Chart for Straight Fittings and Run Legs of Tees and Crosses (Triple-Lok)



Example:



Fig. T5 – Pressure Drop Chart for 45° Elbow Fittings (Triple-Lok)

Dimensions and pressures for reference only, subject to change.

Temperature..... T

Temperature Ratings For Common Tube Materials

Tube Material	Specification	Construction	Condition	Max. Hardness	Temperature Range (7)
Carbon Steel C-1010	SAE J524 (ASTM A179) (8)	Seamless	Fully Annealed	HRB 72	-65° to 500°F -55° to 260°C
	SAE J525 (ASTM A178) (8)	Welded & Drawn			
	SAE J356	Welded & Flash Controlled			
Carbon Steel C-1021	SAE J2467	Welded & Flash Controlled	Fully Annealed	HRB 75	-65° to 500°F -55° to 260°C
	SAE J2435	Welded & Drawn			
Carbon Steel High Strength Low Alloy (HSLA)	SAE 2613	Welded & Flash Controlled	Sub-critically annealed	HRB 90	-65° to 500°F -55° to 260°C
	SAE J2614	Welded & Drawn			
Alloy Steel 4130	ASTM A519	Seamless			-65° to 500°F -55° to 260°C
St 37.4 (Carbon Steel)	DIN 2391 Part 2 (Metric)	Seamless	Fully Annealed	HRB 72	-65° to 500°F -55° to 260°C
Stainless Steel 304 & 316	ASTM A213 ASTM A269	Seamless	Fully Annealed	HRB 90	-425° to 1200° -255° to 650°C (3)
	ASTM A249 ASTM A269	Welded & Drawn			
1.4571 1.4541 Stainless Steel	DIN 17458 Tab 8 (Metric)	Seamless	Fully Annealed	HRB 90	-425° to 1200° -255° to 650°C (3)
Copper	SAE J528 (ASTM B-75) (8)	Seamless	Soft Annealed Temper 0	60 Max. Rockwell 15T	-325° to 400°F -200° to 205°C
Aluminum 6061	ASTM-B210	Seamless	T6 Temper	HRB 56	-325° to 400°F -200° to 205°C
			0 & T4 Temper	HRB 30	
Monel 400	ASTM-B165	Seamless	Fully Annealed	HRB 70	-400° to 800°F -240° to 425°C
Nylon		Extruded	Flexible & Semi-Rigid		-60° to 200°F -50° to 95°C
Polyethylene	ASTM D-1248	Extruded	Instrument Grade		-80° to 150°F -60° to 65°C
PVC		Extruded	Instrument & Laboratory Grade		0° to 140°F -20° to 60°C
PFTE		Extruded & Cinkered			-65° to 400°F -55° to 205°C

Table T6 – Temperature Ratios for Common Tube Materials

Tube Derating Factors for Temperature

Besides severity of service, high operating temperature also reduces allowable working pressure of the tubing. Temperature derating factors for various tube materials are given in Table T7. Where applicable, derating factors for severity of service and temperature should be applied to the design pressure values in Tables T17 and T18 to arrive at the maximum recommended working pressure.

Example: Combined derating factor for 316SS tubing for B (severe) service and 500°F. operation is .67 x .9 = .603

Tube Selection Example:

*The derating factors are based on allowable design stress values at various temperatures per ASME B31.1 code for pressure piping (1986).

Maximum Operating Temperature	Steel C-1010 and C-4130	Stainless Steel		Copper	Aluminum 6061-T6	Monel Type 4000
		304	316			
100	1.00	1.00	1.00	1.00	1.00	1.00
150	1.00	0.91	1.00	0.85	1.00	0.97
200	1.00	0.84	1.00	0.80	1.00	0.94
250	1.00	0.79	1.00	0.80	0.94	0.91
300	1.00	0.75	1.00	0.78	0.80	0.88
350	0.99	0.72	0.99	0.67	0.60	0.86
400	0.98	0.69	0.97	0.50	0.43	0.85
500	0.96	0.65	0.90			0.84
600		0.61	0.85			0.84
700		0.59	0.82			0.84
800		0.57	0.80			0.83
900		0.54	0.78			
1000		0.52	0.77			
1100		0.47	0.62			
1200		0.32	0.37			

Table T7 – Temperature Derating Factors* for Tubes

O-Ring Material Selection.....



Standard O-Rings supplied with Parker tube fittings and adapters are 90 durometer hard nitrile (Buna-N) Parker compound #N0552 or similar. These O-Rings are well suited for most industrial hydraulic and pneumatic systems. They have high extrusion resistance making them suitable for very high pressure static applications. Optional high temperature fluorocarbon, Parker compound #V0894, is also available for higher temperature specifications.

O-Rings for other than normal hydraulic media or higher temperature applications can be selected from the following chart. The chart should be used only as a general guide. Before making final selection for a given application, it is recommended that appropriate tests be conducted to assure compatibility with the fluid, temperature, pressure and other environmental conditions.

For fluids not shown in the chart, please contact the Tube Fittings Division.

Polymer	Abbreviated Name	Parker Compound No.	Color	SAE j515 Type	Hardness Shore "A" ⁷⁾	Temperature Range (°F)	Recommended For	Not Recommended For
Nitrile-Butadiene	NBR	N0552	Black	CH ²⁾	90 ⁶⁾	-30° to 250°	Petroleum base oils and fluids, mineral oils, ethylene glycol base fluids, silicone and di-ester base lubricants, air, water under 150°F, and natural gas.	Phosphate ester base hydraulic fluids, automotive brake fluids, strong acids, ozone, freons, ketones, halogenated hydrocarbons, and methanol.
Nitrile-Butadiene	NBR	N0674	Black	—	70	-30° to 250°		
Nitrile-Butadiene	NBR	N0103	Black	—	70	-65° to 225°		
Nitrile-Butadiene (Low compression set)	NBR	N1059	Black	CH ²⁾	90	-30° to 275°	Hydrogen fuel cells. Hydrogen fuel cells. Meets FDA requirements for food products. CNG Applications	
Nitrile-Butadiene	NBR	N0507	Black	—	90	-65° to 180°		
Nitrile-Butadiene	NBR	N0304	Black	—	75	-65° to 225°		
Nitrile-Butadiene	NBR	N0508	Black	—	—	-35° to 250°		
Nitrile-Butadiene	NBR	N0756	Black	—	75 ⁶⁾	-65° to 275°	Phosphate ester base hydraulic fluids, hot water, steam to 400°F, silicone oils and greases, dilute acids and alkalis, ketones, alcohols and automotive brake fluids.	Petroleum base oils and di-ester base lubricants.
Ethylene-Propylene	EPDM	E0540	Black	CA ³⁾	80	-65° to 275°		
Ethylene-Propylene	EPDM	E0893	Purple ¹⁾	CA ³⁾	80	-65° to 275°	CO2 climate control systems.	
Ethylene-Propylene	EPDM	E0962	Black	—	90	-65° to 275°		
Neoprene	CR	C0873	Black	—	70	-45° to 250°	Refrigerants (freons, ammonia), high aniline point petroleum oils, mild acids, and silicate ester lubricants.	Phosphate ester fluids and ketones.
Neoprene	CR	C0944	Red ¹⁾	—	70	-45° to 250°		
Fluorocarbon	FKM ⁵⁾ or FPM	V0747 V0884 V0894	Black Brown ¹⁾ Brown ^{1), 5)}	— — HK ⁴⁾	75 75 90 ⁶⁾	-15° to 400° -15° to 400° -15° to 400°	Petroleum base oils and fluids, some phosphate ester base fluids, silicone and silicate ester base lubricants, di-ester base lubricants, acids and halogenated hydrocarbons.	Ketones, skydrol fluids, amines (VDMH), anhydrous ammonia, low molecular weight esters and ethers, and hot hydrofluoric or chlorosulfonic acids.
Silicone	Si	S0604	Rust ¹⁾	—	70	-65° to 450°	Dry heat (air to 400°F) and high aniline point oils.	Most petroleum fluids, ketones, water and steam.

Table T8 – O-Ring Selection

- 1) These Parker "Chromasure" color assurance O-Rings are available from the Parker Hannifin O-Ring Division. They help eliminate assembly errors, reduce warranty costs and liability risks, and assure safety in aftermarket business.
- 2) Formerly SAE Type I.
- 3) Formerly SAE Type II.
- 4) Formerly SAE Type III.
- 5) "FKM" is the ASTM designation for fluorocarbon. Its ISO designation is "FPM". For "DIN" Fittings, color is green.
- 6) Standard compounds available from stock.
- 7) Use 90 durometer hard O-Rings for applications with 1500 psi or higher pressures.

Dimensions and pressures for reference only, subject to change.



Application A

Connector Proliferation

Today many different types of connectors are being used around the world. Most of these have come about through historical use and local preference for a certain design concept. Some connections of the North American origin such as four bolt flange, SAE straight thread and 37° Flare have found some degree of acceptance and use in Europe and Japan as a result of the exports of U.S. machinery to the regions after World War II. But, large majority of usage is made up of a variety of indigenous port and tube connections. A quick review of the commonly used connections around the world reveals that there are eight different port connections and eleven different tube/hose connections.

Port Connections

NPTF	ISO 6149 (Metric Straight Thread O-Ring Port)
SAE Straight Thread (UN/UNF)	JIS-PT (BSPT)
4-Bolt Flange	JIS-B2351 (BSPP similar to SAE)
ISO 1179 (BSPP)	
ISO 9974 (Metric)	

Tube/Hose Connections:

37° Flare (SAE)	30° Flare, BSPP (JIS)
24° Flareless, Inch Threads (SAE)	24° Flareless, Metric (JIS)
60° Cone Swivel, NPSM (SAE)	60° Cone, BSPP (JIS)
O-Ring Face Seal (SAE)	60° Cone, Metric (JIS)
24° Cone, Metric (DIN)	37° Flare, Metric (Russia)
60° Cone, BSPP (BSi)	

The Challenge

Leakage is no longer acceptable in world class products. Above proliferation, besides limiting availability and increasing cost, increases leakage potential through misapplications. Therefore, the challenge facing the fluid power industry is two fold — eliminate leakage and minimize proliferation.

Meeting The Challenge

This challenge has been met through a very intensive and cooperative effort by the member nations of

sub-committee 4 of the ISO Technical Committee 131 (ISO/TC131) The sub-committee started this effort in 1989 and has completed development of performance based standards for the most widely used ports and tube/hose connections to limit proliferation, and strongly endorsing those with elastomeric seals to eliminate leakage in hydraulic systems.

Ten ports, eight threaded and two four bolt flange, and four tube/hose connections as shown on page T12 have been standardized. The threaded ports and tube/hose connections are paired in the ISO 8434 series of fitting standards as defined in the table below.

To minimize proliferation in port usage and promote leak free connections, the sub-committee strongly endorses use of ISO 6149 port for all new designs by including the following statement in all port standards:

“For threaded ports and stud ends specified in new designs in hydraulic fluid power applications, only ISO 6149 shall be used. Threaded ports and stud ends in accordance with ISO 1179, ISO 9974 and ISO 11926 shall not be used for new designs in hydraulic fluid power applications.”

On the tube/hose connection side, only ISO 8434-3 (O-Ring Face Seal) and ISO 8434-4 (24° cone with weld nipple) feature elastomeric seal for zero leak performance. Combining these with the ISO 6149 for the port connection leads to two (2) combinations (complete fittings) for use in leak-free world class products. They are:

ISO 8434-3	O-Ring Face Seal and ISO 6149 Port
ISO 8434-4	24° Cone With Soft Seal and ISO 6149 Port

For large port connections, the four bolt flange connection per ISO 6162 (SAE J518 is included in ISO 6162) remains widely used and the recommended connection.

Application	Port	Tube/Hose Connection			
		24° Cone Flareless (DIN) (Bite Type)	37° Flare (Inch Threads)	ORFS	24° Cone Weld Nipple
For All Designs	Metric ISO 6149 (SAE J2244)	ISO 8434-1	ISO 8434-2	ISO 8434-3	ISO 8434-4*
Not for New Designs in Hydraulic Fluid Power	Metric ISO 1179 (DIN 3852-2)	ISO 8434-1	ISO 8434-2	--	ISO 8434-4*
	Metric ISO 9974 (DIN 3852-1)	ISO 8434-1	--	--	ISO 8434-4*
	UN/UNF ISO 11926 (SAE J1926)	--	ISO 8434-2	--	--

Table T9 – ISO Standard Port and Tube/Hose Connection Combinations

*Will be included in ISO 8434-1 at the next revision.

Dimensions and pressures for reference only, subject to change.



Tube/Hose End Summary.....





Tube/Hose End Type	Illustration	Pressure – Dynamic	Pressure – Static	Seal Reliability	Vibration Resistance (in Rigid Systems)	Ease of Installation	Ease of Maintenance	Reusability	Temperature
Seal-Lok O-Ring Face Seal		Excellent	Excellent	Excellent	Very Good	Excellent	Excellent	Excellent	Limited by Seal
Triple-Lok 37° Flare		Very Good	Very Good	Good	Good	Good	Very Good	Good	Excellent
Ferulok Inch Bite Type		Very Good	Very Good	Very Good	Very Good	Good	Good	Very Good	Excellent
EO Metric Bite Type		Excellent	Excellent	Very Good	Very Good	Good	Good	Very Good	Excellent
EO-2 Soft Seal Metric Bite Type		Excellent	Excellent	Excellent	Very Good	Very Good	Good	Excellent	Limited by Seal
Intru-Lok Brass Flareless		Fair (Low)	Fair (Low)	Very Good	Good	Good	Good	Good	Excellent
JIS 30° Flare		Good	Good	Very Good	Not Applicable	Very Good	Very Good	Very Good	Limited by Seal
JIS 60° Cone B8363		Good	Good	Very Good	Not Applicable	Very Good	Very Good	Very Good	Limited by Seal
Komatsu 30° Flare		Good	Good	Very Good	Not Applicable	Very Good	Very Good	Very Good	Limited by Seal
K4 BSP Adapters		Good	Good	Very Good	Not Applicable	Very Good	Very Good	Very Good	Limited by Seal
NPSM (Swivel)		Good	Good	Very Good	Not Applicable	Good	Good	Very Good	Limited by Seal

Dimensions and pressures for reference only, subject to change.



Port End Summary.....



Port End Type and Seal Style	Illustration	Pressure – Dynamic	Pressure – Static	Temperature	Positioning	Contamination	Seal Reliability	Reusability	Fluid Compatibility
Tapered (NPT, NPTF, BSPT and Metric Taper)		Poor	Good	Excellent	Poor	Poor	Poor	Poor	Excellent
O-Ring in Chamfer (SAE J1926, ISO 6149 and JIS B2351)		Excellent	Excellent	Limited by Seal	Excellent	Very Good	Excellent	Excellent	Limited by Seal
Spot Face with ED Seal (ISO 1179-2 and ISO 9974-2)		Excellent	Excellent	Limited by Seal	Not Applicable	Very Good	Excellent	Excellent	Limited by Seal
Spot Face with Bonded Seal (ISO 1179 and ISO 9974)		Good	Good	Good	Not Applicable	Very Good	Good	Excellent	Limited by Seal
Spot Face with Cutting Face (ISO 1179-4 and ISO 9974-3)		Poor	Fair	Excellent	Not Applicable	Fair	Poor	Poor	Excellent
Spot Face with O-Ring and Retaining Ring (ISO 1179-3)		Good	Good	Good	Excellent	Very Good	Good	Excellent	Limited by Seal
Spot Face with Hard Metal Seal (ISO 1179 and ISO 9974)		Poor	Fair	Excellent	Not Applicable	Fair	Poor	Poor	Excellent
Spot Face with Soft Metal Seal (ISO 1179 and ISO 9974 with copper gasket)		Poor	Fair	Good	Not Applicable	Very Good	Poor	Fair	Excellent
4 Bolt Flange (SAE J518 and ISO 6162)		Excellent	Excellent	Good	Good	Very Good	Good	Excellent	Limited by Seal
4 Bolt Flange (ISO 6164)		Excellent	Excellent	Good	Good	Good	Good	Excellent	Limited by Seal

Dimensions and pressures for reference only, subject to change.



Tube to Port¹⁾ Pairing for Medium Pressure²⁾ Applications



Tube O.D.			Port Thread			
Inch (Dash Size)		Metric (mm.)	SAE	ISO	NPTF	BSPP
1/8	(-2)	4	5/16-24	M8 x 1	1/16-27	G 1/8-28
3/16	(-3)	5	3/8-24	M10 x 1	1/8-27	G 1/8-28
1/4	(-4)	6	7/16-20	M10 x 1	1/8-27	G 1/8-28
5/16	(-5)	8	1/2-20	M12 x 1.5	1/8-27	G 1/4-19
3/8	(-6)	10	9/16-20	M14 x 1.5	1/4-18	G 1/4-19
1/2	(-8)	12	3/4-16	M16 x 1.5	3/8-18	G 3/8-19
—		15	3/4-16	M18 x 1.5	1/2-14	G 1/2-14
5/8	(-10)	16, 18	7/8-14	M22 x 1.5	1/2-14	G 1/2-14
3/4	(-12)	20	1 1/16-12	M27 x 2	3/4-14	G 3/4-14
7/8	(-14)	22	1 3/16-12	M27 x 2	3/4-14	G 3/4-14
1	(-16)	25, 28	1 5/16-12	M33 x 2	1-11 1/2	G 1-11
1 1/4	(-20)	30, 35	1 5/8-12	M42 x 2	1 1/4-11 1/2	G 1 1/4-11
1 1/2	(-24)	38, 42	1 7/8-12	M48 x 2	1 1/2-11 1/2	G 1 1/2-11
2	(-32)	50	2 1/2-12	M60 x 2	2-11 1/2	G 2-11

Table T10 – Tube to Port Pairing for Medium Pressure Applications

- 1) Ports are in accordance with the standards listed below:
SAE J1926-1, ISO 6149-1, NPTF-SAE J476 and BSPP-ISO 1179-1
- 2) The pressure range covering all the sizes shown is 1000 to 5000 PSI.

Tube to Port¹⁾ Pairing for High Pressure²⁾ Applications

Tube O.D.			Port Thread			
Inch (Dash Size)		Metric (mm.)	SAE	ISO	NPTF	BSPP
1/8	(-2)	4	5/16-24	M8 x 1	1/16-27	G 1/8-28
3/16	(-3)	5	3/8-24	M10 x 1	1/8-27	G 1/8-28
1/4	(-4)	6	7/16-20	M12 x 1.5	1/8-27	G 1/8-28
5/16	(-5)	8	1/2-20	M14 x 1.5	1/8-27	G 1/4-19
3/8	(-6)	10	9/16-20	M16 x 1.5	1/4-18	G 1/4-19
1/2	(-8)	12	3/4-16	M18 x 1.5	3/8-18	G 3/8-19
5/8	(-10)	14, 16	7/8-14	M22 x 1.5	1/2-14	G 1/2-14
3/4	(-12)	20	1 1/16-12	M27 x 2	3/4-14	G 3/4-14
7/8	(-14)	—	1 3/16-12	M30 x 2	3/4-14	G 3/4-14
1	(-16)	25	1 5/16-12	M33 x 2	1-11 1/2	G 1-11
1 1/4	(-20)	30	1 5/8-12	M42 x 2	1 1/4-11 1/2	G 1 1/4-11
1 1/2	(-24)	38	1 7/8-12	M48 x 2	1 1/2-11 1/2	G 1 1/2-11
2	(-32)	50	2 1/2-12	M60 x 2	2-11 1/2	—

Table T11 – Tube to Port Pairing for High Pressure Applications

- 1) Ports are in accordance with the standards listed below:
SAE J1926-1, ISO 6149-1, NPTF-SAE J476 and BSPP-ISO 1179-1
- 2) The pressure range covering all the sizes shown is 2500 to 9000 PSI.

Dimensions and pressures for reference only, subject to change.



Conformance to Applicable Specifications and Approvals for TFD Products by Product Type or Subject

Fittings	Specifications
Seal-Lok	SAE J1453
Metric Seal-Lok	ISO 8434-3
Triple-Lok	SAE J514
	MIL-F-18866, MS Sheets*
	MS51500 - MS51534*
	BS43687, part 4
Ferulok	ISO 8434-2
	SAE J514
	MIL-F-18866 MS Sheets* MS51811 - MS51843*
EO/EO-2	U.S. Coast Guard - meet applicable requirements of ASTM F1387
	DIN 3861
	ISO 8434-1-4, ISO 8434-4 (former DIN 2353)
	DIN 3865
Flange Adapters	DIN 3859
	SAE J518
	ISO 6162-1
	ISO 6162-2
JIS Adapters*	ISO 6164
K4 Adapters	JIS B8363 (with some exceptions)
Pipe Fittings	BS 5200, ISO 8434-6*
Pipe Plugs	SAE J514
Straight Thread Plugs	SAE J531
Pipe Swivel Adapters	SAE J514
All catalog products	SAE J514
	Canadian Registration

Approvals:

Parker tube fittings are recognized by various acceptance organizations, among which are:

- Germanischer Lloyd (GL)
- Lloyds Register of Shipping (LR)
- Det Norske Veritas (DNV)
- American Bureau of Shipping (ABS)
- Russian Maritime Register of Shipping (RMS)
- China Classification Society (CCS)
- Deutscher Verein des Gas- und Wasserfaches (DVGW)
- Canadian Technical Standards and Safety Registration (CRN)

For other applications, Parker tube fittings also approved by diverse national authorities.

Numerous original equipment manufacturers and end-users of various industries have approved Parker tube fittings.

Attention:

Type Approvals usually are limited to certain products, applications, working conditions, validity time or other restrictions. We will gladly inform you on your individual application and send out the required documentation.

Plating	Specification
Carbon Steel – Chromium 6 Free Zinc	ASTM B633 Type II FE/ZN8** **Clear/Silver Color
	MIL-STD-171E
	JIS 8610 Class 1 Grade 3
Stainless Steel Passivation	QQ-P35 Type VI
	ASTM A380
Carbon Steel – Zinc Phosphate	DOD-P-16232, Class 1

Plating	Specification	Comment
Products	ASME / ANSI B31.1	All products meet the design factor requirements of this specification.

Test Methods	Specification
Leak, Burst, Impulse, Over-Torque and Repeated Assembly	SAE J1644 (cancelled)
	ISO 19879
Vibration	NFPA T3.8.3, ISO 7257

Table T12 – Conformance Standards

*Some parts do not meet dimensional requirements.

Dimensions and pressures for reference only, subject to change.



Media



Fluid Compatibility

The fluid compatibility chart on the following page is intended as a guide only and is not to be considered as a sole selection criteria to use Parker Tube Fittings in a specific application or with a specific fluid. Other factors that must be considered include, but are not limited to: Fluid temperature, ambient temperature, system pressure (both operating and peak) and applicable standards or regulations. For media not listed, please contact your Parker representative or the Tube Fittings Division.

Protective Coatings on Steel

Protective coatings such as electroplated zinc and cadmium¹⁾ and zinc phosphate are usually applied to steel fittings for extending their useful service life in corrosive environments. Cadmium and zinc corrode sacrificially, protecting the steel substrate from normal atmospheric rusting due to the common presence of oxygen, moisture and acidic gases. They are, however, rapidly attacked by many fluids including those containing acidic hydrogen and reactive fluorine, chlorine, bromine, iodine, and nitrogen. **Zinc plating will further be attacked by strong bases or water with pH > 12. Zinc reacts with glycol based fire resistant fluids and forms a gelatinous compound that can plug up filters and be harmful otherwise, in a system with many zinc plated tube and hose fittings.** Steel fittings with zinc phosphate coating or stainless steel fittings, along with brass fittings in low pressure applications, are viable options.

The other option is to run the fluid through the system, without components with moving parts in it, with an auxiliary power source, to generate and flush the gelatinous compound. Then re-connect all components, change filters and charge the system with new fluid.

The corrosion resistance of the Chromium-6 Free standard surface treatment is a minimum of 25% improved over traditional zinc gold (hexavalent) chromate surface. Additionally, the Chromium-6 Free surface meets the EU end of life vehicle directive and ROHS compliance.

Zinc-Nickel (Parker XTR) plating offers enhanced performance over both Chromium-6 Free (standard treatment) and traditional zincgold hexavalent chromate surfaces. Parker XTR plating increases protection in salt spray (ASTM B117) testing and in fertilizer (urea) applications.

Caution: Where low toxicity and low corrosion are required, as in food or beverage applications, steel coated with any form of zinc or other protective coatings is not recommended.

Notes:

- 1) Caution: Where low toxicity and low corrosion are required as in food or beverage applications, steel coated with any form of zinc or other protective coatings is not recommended.

Choosing the Tube Material and Type

Selection of tube material depends on the fluid, corrosive nature of the service environment, the operating temperature range and the maximum operating pressure. The tube O.D. and wall thickness selection depends on these four parameters.

A simple method of selecting the proper tube type and material is described below.

Table T16 lists several common tube types with their recommended operating temperature ranges, general application, and fitting compatibility. Based on the fluid system parameters and media, select the appropriate tube type and material.

If media and/or service environment is different from the commonly used ones listed in the general application column, please consult the Fluid Compatibility chart on the following page or contact the Tube Fittings Division.

For selecting proper tube O.D. and wall thickness use the procedure given on pages T4 and T28.

Caution: When working with highly corrosive media, always consult the Tube Fittings Division.



Media	Fitting Material			Seal Material			
	Brass	Steel	316 SS	BUNA-N	Ethylene Propylene	Fluorocarbon	Neoprene
Acetylene	NR	F	S	S	S	S	F
Air (oil free) @ 190°F	S	F	S	S	S	S	S
Air (oil free) @ 300°F	S	F	S	F	F	S	F
Air (oil free) @ 400°F	S	F	S	NR	NR	S	NR
Alcohol, Ethyl	S	NR	NR	NR	S	NR	S
Animal Oils (Lard Oil)	F	F	F	S	F	S	F
Aromatic Fuel - 50%	ID	ID	ID	F	NR	S	NR
Aromatic Solvents	ID	ID	F	F	ID	S	NR
Asphalt	NR	NR	S	F	NR	S	F
ASTM Oil #1	S	S	S	S	NR	S	S
ASTM Oil #2	S	S	S	S	NR	S	F
ASTM Oil #3	S	S	S	S	NR	S	NR
ASTM Oil #4	S	S	S	F	NR	S	NR
ATF Oil	S	S	S	S	NR	S	F
Automotive Brake Fluid	ID	ID	ID	NR	S	NR	F
Benzene	NR	F	NR	NR	NR	S	NR
Brine (Sodium Chloride)	NR	NR	S	S	S	S	S
Butane	NR	S	S	S	NR	S	S
Carbon Dioxide	S	F	S	S	S	S	S
Carbon Monoxide	S	S	S	S	S	S	F
Chlorine (Dry)	F	F	NR	NR	ID	F	F
Compressed Air	S	F	S	S	S	S	S
Crude Oil	NR	F	S	F	NR	S	NR
Cutting Oil	ID	S	S	S	NR	S	F
Diesel Fuel	S	S	S	S	NR	S	NR
Ethanol	S	NR	NR	NR	S	NR	S
Ethers	S	S	S	NR	F	F	NR
Freon 11	S	ID	ID	F	NR	F	NR
Freon 12	S	S	NR	F	NR	S	S
Freon 22	S	NR	S	NR	NR	NR	S
Fuel Oil	NR	S	S	S	NR	S	F
Gasoline	S	F	S	S	NR	S	NR
Gas, Liquid Propane (LPG)	S	S	S	S	NR	S	F
Gas, Natural	F	S	S	S	NR	S	S
Helium	S	S	S	S	S	S	S
Hydraulic Oil, Petroleum Base	S	S	S	S	NR	S	S
Hydraulic Oil, Water Base	ID	S	S	F	S	NR	F
Hydrogen Gas	S	S	S	S	S	S	S
Jet Fuel	S	S	S	S	NR	S	NR
Kerosene	S	S	S	S	NR	S	F
Lubricating Oil SAE 10, 20, 30, 40, 50	S	S	S	S	NR	S	F
Methanol	S	S	S	S	S	NR	S
MIL-F-8192 (JP-9)	S	S	S	NR	NR	S	NR
MIL-H-5606	S	S	S	S	NR	S	F
MIL-H-6083	S	S	S	S	NR	S	S
MIL-H-7083	S	S	S	S	S	F	F
MIL-H-8446 (MLO-8515)	F	S	S	F	NR	S	S
Mil-L-2104 & 2104B	S	S	S	S	NRX	S	F
MIL-L-7808	NR	F	S	S	NR	S	NR
Mineral Oil	S	S	S	F	NR	S	F
Nitrogen	S	S	S	F	S	S	S
Petrolatum	S	S	S	S	NR	S	F
Petroleum Oil (<250°F)	S	S	S	S	NR	S	F
Propane	S	S	S	S	NR	S	F
R134A	S	S	S	NR	S	NR	NR
Sea Water	F	NR	S	S	S	S	F
Skydrol 500, Type 2	NR	S	S	NR	S	NR	NR
Skydrol 7000, Type 2	NR	S	S	NR	S	F	NR
Soap Solutions	NR	NR	S	S	S	S	F
Steam (<400°F)	F	S	S	NR	S	NR	NR
Stoddard Solvent	F	S	S	S	NR	S	F
Transmission Fluid (Type A)	S	S	S	S	NR	S	F
Trichloroethane	ID	F	S	NR	NR	S	NR
Water	S	F	S	S	S	F	F

Table T13 – Fluid Compatibility Chart Codes: S = Satisfactory F = Fair NR = Not recommended ID = Insufficient Data
Dimensions and pressures for reference only, subject to change.



Corrosion of Base Metals in Contact **M**

The susceptibility of different base metals to corrosion while incontact, depends upon the difference between the contact potentials, or the electromotive voltages of the metals involved. The greater the potential difference is, the greater is the tendency for corrosion. The metal with the higher potential forms the anode and is corroded. In other words, the larger the separation distance in the electromotive chart between the two metals in contact, the higher the contact potential and chances for corrosion. For example, zinc and aluminum are very short distance apart in the chart;

therefore potential for corrosion when these two metals are in contact is very low. On the other hand, aluminum and passivated 316 stainless steel are far apart; hence, when in contact, the potential for corrosion is very high. Aluminum, being more anodic metal, will corrode in this combination.

As a general guideline, if the metals are half the length of the chart or more apart, the combination should be avoided. Also, it is not a good idea to combine an anodic metal part with thin cross section, such as thin wall tubing, with a cathodic or less anodic metal part of a heavy cross section, such as a fitting.

Example: A thin wall brass tube with steel fitting is a better, although not ideal, combination than a thin wall steel tube with brass fitting.

Electromotive or Galvanic Series for Metals	
+ Anodic (least noble) corroded ↑ ↓ - Cathodic (most noble) protected Electric current flows from plus to minus Direction of attack	Magnesium
	Magnesium Alloys
	Zinc (Parker steel fittings are zinc plated)
	Zinc-Nickel (Parker XTR Plating)
	Beryllium
	Aluminum 5052, 3004, 3003, 1100, 6053
	Cadmium
	Aluminum 2117, 2017, 2024 T4
	Mild steel (1018), wrought iron, free machining steel (12L14)
	Low alloy high strength steel, cast iron
	Chrome iron (active)
	430 Stainless (active)
	302, 303, 321, 347, 410, 416, stainless steel (active)
	Ni-resist
	316, 317 stainless steel (active)
	Carpenter 20Cb-3 stainless (active)
	Aluminum bronze (CA 687)
	Hastelloy C (active) Inconel 625 (active) Titanium (active)
	Lead/Tin solder
	Lead
	Tin
	Inconel 600 (active)
	Nickel (active)
	60 Ni-15 Cr (active)
	80 Ni-20 Cr (active)
	Hastelloy B (active)
	Naval brass (CA 464), Yellow brass (CA 268), Brass (CA360)
	Red brass (CA 230), Admiralty brass (CA 443)
	Copper (CA 102)
	Maganese bronze (CA 675), Tin bronze (CA 903, 905)
	410, 416 Stainless (passive) Phosphor bronze (CA 521, 524)
	Silicon bronze (CA 651, 655)
	Nickel silver (CA 732, 735, 745, 752, 754, 757, 764, 770, 794)
	Cupro Ni 90-10
	Cupro Ni 80-20
	430 Stainless steel (passive)
	Cupro Ni 70-30
	Nickel aluminum bronze (CA 630, 632)
	Monel 400, K500
	Silver solder
Nickel (passive)	
60 Ni 15 Cr (passive)	
Inconel 600 (passive)	
80 Ni 20 Cr (passive)	
Chrome iron (passive)	
302, 303, 304, 321, 347 stainless steel (passive)	
316, 317 stainless steel (passive) (Parker stainless steel fittings are passivated)	
Carpenter 20 Cb-3 stainless (passive), Incoloy 825	
Silver	
Titanium (passive), Hastelloy C & C276 (passive), Inconel 625 (passive)	
Graphic	
Zirconium	
Gold	
Platinum	

Table T14 – Electromotive or Galvanic Series for Metals

O-Ring Material Selection.....

Standard O-Rings supplied with Parker tube fittings and adapters are 90 durometer hard nitrile (Buna-N) Parker compound #N0552 or similar. These O-Rings are well suited for most industrial hydraulic and pneumatic systems. They have high extrusion resistance making them suitable for very high pressure static applications. Optional high temperature fluorocarbon, Parker compound #V0894, is also available for higher temperature specifications.

O-Rings for other than normal hydraulic media or higher temperature applications can be selected from the following chart. The chart should be used only as a general guide. Before making final selection for a given application, it is recommended that appropriate tests be conducted to assure compatibility with the fluid, temperature, pressure and other environmental conditions.

For fluids not shown in the chart, please contact the Tube Fittings Division or Parker Seal Group.

Recommended for	Temperature Range	Not Recommended For	Polymer	Abbreviated Name	Parker Compound	No. Color	SAE J515 Type	Shore Hardness
Acids	-15° to 400°F	Ketones, skydrol fluids, amines (VDMH), anhydrous ammonia, low molecular weight esters and ethers, hot hydrofluoric or chlorosulfuric acids	Fluorocarbon	FKM [®] or FPM	V0747	Black	—	75
Acids	-15° to 400°F	Ketones, skydrol fluids, amines (VDMH), anhydrous ammonia, low molecular weight esters and ethers, hot hydrofluoric or chlorosulfuric acids	Fluorocarbon	FKM [®] or FPM	V0884	Brown ¹⁾	—	75
Acids	-15° to 400°F	Ketones, skydrol fluids, amines (VDMH), anhydrous ammonia, low molecular weight esters and ethers, hot hydrofluoric or chlorosulfuric acids	Fluorocarbon	FKM [®] or FPM	V0894	Brown ^{1),5)}	HK ⁴⁾	90 ⁶⁾
Air	-30° to 250°	Phosphate ester base hydraulic fluids, automotive brake fluids, strong acids, ozone, freons, ketones, halogenated hydrocarbons and methanol	Nitrile-Butadiene	NBR	N0674	Black	—	70
Air	-30° to 250°F	Phosphate ester base hydraulic fluids, automotive brake fluids, strong acids, ozone, freons, ketones, halogenated hydrocarbons and methanol	Nitrile-Butadiene	NBR	N0552	Black	CH ²⁾	90 ⁶⁾
Air	-30° to 275°F	Phosphate ester base hydraulic fluids, automotive brake fluids, strong acids, ozone, freons, ketones, halogenated hydrocarbons and methanol	Nitrile-Butadiene	NBR	N1059	Black	CH ²⁾	90
Air	-65° to 225°	Phosphate ester base hydraulic fluids, automotive brake fluids, strong acids, ozone, freons, ketones, halogenated hydrocarbons and methanol	Nitrile-Butadiene	NBR	N0103	Black	—	70
Alcohols	-65° to 225°F	Petroleum based oils and di-ester base lubricants	Ethylene-Propylene	EPDM	E0540	Black	CA ³⁾	80
Alcohols	-65° to 225°F	Petroleum based oils and di-ester base lubricants	Ethylene-Propylene	EPDM	E0893	Purple ¹⁾	CA ³⁾	80
Automotive brake fluids	-65° to 225°F	Petroleum based oils and di-ester base lubricants	Ethylene-Propylene	EPDM	E0540	Black	CA ³⁾	80
Automotive brake fluids	-65° to 225°F	Petroleum based oils and di-ester base lubricants	Ethylene-Propylene	EPDM	E0893	Purple ¹⁾	CA ³⁾	80
CO2 Climate control systems	-65° to 225°F	Petroleum based oils and di-ester base lubricants	Ethylene-Propylene	EPDM	E0962	Black	—	90
CNG Applications	-65° to 225°F	Phosphate ester base hydraulic fluids, automotive brake fluids, strong acids, ozone, freons, ketones, halogenated hydrocarbons and methanol	Nitrile-Butadiene	NBR	N0756	Black	—	75 ⁶⁾
Di-ester base lubricants	-15° to 400°F	Ketones, skydrol fluids, amines (VDMH), anhydrous ammonia, low molecular weight esters and ethers, hot hydrofluoric or chlorosulfuric acids	Fluorocarbon	FKM [®] or FPM	V0747	Black	—	75
Di-ester base lubricants	-15° to 400°F	Ketones, skydrol fluids, amines (VDMH), anhydrous ammonia, low molecular weight esters and ethers, hot hydrofluoric or chlorosulfuric acids	Fluorocarbon	FKM [®] or FPM	V0884	Brown ¹⁾	—	75
Di-ester base lubricants	-15° to 400°F	Ketones, skydrol fluids, amines (VDMH), anhydrous ammonia, low molecular weight esters and ethers, hot hydrofluoric or chlorosulfuric acids	Fluorocarbon	FKM [®] or FPM	V0894	Brown ^{1),5)}	HK ⁴⁾	90 ⁶⁾
Dilute acids and alkalis	-65° to 275°F	Petroleum based oils and di-ester base lubricants	Ethylene-Propylene	EPDM	E0540	Black	CA ³⁾	80
Dilute acids and alkalis	-65° to 275°F	Petroleum based oils and di-ester base lubricants	Ethylene-Propylene	EPDM	E0893	Purple ¹⁾	CA ³⁾	80
Dry heat (air to 400°F)	-65° to 450°F	Most petroleum fluids, ketones, water and steam	Silicone	Si	S0604	Rust ¹⁾	—	70
Ethylene glycol base fluids	-30° to 250°	Phosphate ester base hydraulic fluids, automotive brake fluids, strong acids, ozone, freons, ketones, halogenated hydrocarbons and methanol	Nitrile-Butadiene	NBR	N0674	Black	—	70

Dimensions and pressures for reference only, subject to change.





Recommended for	Temperature Range	Not Recommended For	Polymer	Abbreviated Name	Parker Compound	No. Color	SAE J515 Type	Shore Hardness
Ethylene glycol base fluids	-30° to 250°F	Phosphate ester base hydraulic fluids, automotive brake fluids, strong acids, ozone, freons, ketones, halogenerated hydrocarbons and methonal	Nitrile-Butadiene	NBR	N0552	Black	CH ²⁾	90 ⁶⁾
Ethylene glycol base fluids	-30° to 275°F	Phosphate ester base hydraulic fluids, automotive brake fluids, strong acids, ozone, freons, ketones, halogenerated hydrocarbons and methonal	Nitrile-Butadiene	NBR	N1059	Black	CH ²⁾	90
Ethylene glycol base fluids	-65° to 225°	Phosphate ester base hydraulic fluids, automotive brake fluids, strong acids, ozone, freons, ketones, halogenerated hydrocarbons and methonal	Nitrile-Butadiene	NBR	N0103	Black	—	70
Food product applications (meets FDA requirements)	-35° to 250°	Phosphate ester base hydraulic fluids, automotive brake fluids, strong acids, ozone, freons, ketones, halogenerated hydrocarbons and methonal	Nitrile-Butadiene	NBR	N0508	Black	—	75
Halogenated hydrocarbons	-15° to 400°F	Phosphate ester base hydraulic fluids, automotive brake fluids, strong acids, ozone, freons, ketones, halogenerated hydrocarbons and methonal	Fluorocarbon	FKM ⁵⁾ or FPM	V0747	Black	—	75
Halogenated hydrocarbons	-15° to 400°F	Ketones, skydrol fluids, amines (VDMH), anhydrous ammonia, low molecular weight esters and ethers, hot hydrofluoric or chlorosulfuric acids	Fluorocarbon	FKM ⁵⁾ or FPM	V0884	Brown ¹⁾	—	75
Halogenated hydrocarbons	-15° to 400°F	Ketones, skydrol fluids, amines (VDMH), anhydrous ammonia, low molecular weight esters and ethers, hot hydrofluoric or chlorosulfuric acids	Fluorocarbon	FKM ⁵⁾ or FPM	V0894	Brown ^{1),5)}	HK ⁴⁾	90 ⁶⁾
High aniline point oils	-65° to 450°F	Most petroleum fluids, ketones, water and steam	Silicone	Si	S0604	Rust ¹⁾	—	70
High aniline point petroleum oils	-45° to 250°F	Phosphate ester fluids and ketones	Neoprene	CR	C0873	Black	—	70
High aniline point petroleum oils	-45° to 250°F	Phosphate ester fluids and ketones	Neoprene	CR	C0944	Red ¹⁾	—	70
Hot water	-65° to 275°F	Petroleum based oils and di-ester base lubricants	Ethylene-Propylene	EPDM	E0540	Black	CA ³⁾	80
Hot water	-65° to 275°F	Petroleum based oils and di-ester base lubricants	Ethylene-Propylene	EPDM	E0893	Purple ¹⁾	CA ³⁾	80
Hydrogen Fuel Cells	-65° to 180°F	Phosphate ester base hydraulic fluids, automotive brake fluids, strong acids, ozone, freons, ketones, halogenerated hydrocarbons and methonal	Nitrile-Butadiene	NBR	N0507	Black	—	90
Hydrogen Fuel Cells	-65° to 225°F	Phosphate ester base hydraulic fluids, automotive brake fluids, strong acids, ozone, freons, ketones, halogenerated hydrocarbons and methonal	Nitrile-Butadiene	NBR	N0304	Black	—	75
Ketones	-65° to 275°F	Petroleum based oils and di-ester base lubricants	Ethylene-Propylene	EPDM	E0540	Black	CA ³⁾	80
Ketones	-65° to 275°F	Petroleum based oils and di-ester base lubricants	Ethylene-Propylene	EPDM	E0893	Purple ¹⁾	CA ³⁾	80
Mild Acids	-45° to 250°F	Phosphate ester fluids and ketones	Neoprene	CR	C0873	Black	—	70
Mild Acids	-45° to 250°F	Phosphate ester fluids and ketones	Neoprene	CR	C0944	Red ¹⁾	—	70
Mineral Oils	-30° to 250°	Phosphate ester base hydraulic fluids, automotive brake fluids, strong acids, ozone, freons, ketones, halogenerated hydrocarbons and methonal	Nitrile-Butadiene	NBR	N0674	Black	—	70
Mineral Oils	-30° to 250°F	Phosphate ester base hydraulic fluids, automotive brake fluids, strong acids, ozone, freons, ketones, halogenerated hydrocarbons and methonal	Nitrile-Butadiene	NBR	N0552	Black	CH ²⁾	90 ⁶⁾
Mineral Oils	-30° to 275°F	Phosphate ester base hydraulic fluids, automotive brake fluids, strong acids, ozone, freons, ketones, halogenerated hydrocarbons and methonal	Nitrile-Butadiene	NBR	N1059	Black	CH ²⁾	90
Mineral Oils	-65° to 225°	Phosphate ester base hydraulic fluids, automotive brake fluids, strong acids, ozone, freons, ketones, halogenerated hydrocarbons and methonal	Nitrile-Butadiene	NBR	N0103	Black	—	70
Natural Gas	-30° to 250°	Phosphate ester base hydraulic fluids, automotive brake fluids, strong acids, ozone, freons, ketones, halogenerated hydrocarbons and methonal	Nitrile-Butadiene	NBR	N0674	Black	—	70
Natural Gas	-30° to 250°F	Phosphate ester base hydraulic fluids, automotive brake fluids, strong acids, ozone, freons, ketones, halogenerated hydrocarbons and methonal	Nitrile-Butadiene	NBR	N0552	Black	CH ²⁾	90 ⁶⁾

Dimensions and pressures for reference only, subject to change.



Recommended for	Temperature Range	Not Recommended For	Polymer	Abbreviated Name	Parker Compound	No. Color	SAE J515 Type	Shore Hardness
Natural Gas	-30° to 275°F	Phosphate ester base hydraulic fluids, automotive brake fluids, strong acids, ozone, freons, ketones, halogenated hydrocarbons and methonal	Nitrile-Butadiene	NBR	N1059	Black	CH ²⁾	90
Natural Gas	-65° to 225°	Phosphate ester base hydraulic fluids, automotive brake fluids, strong acids, ozone, freons, ketones, halogenated hydrocarbons and methonal	Nitrile-Butadiene	NBR	N0103	Black	—	70
Petroleum based oils and fluids	-30° to 250°	Phosphate ester base hydraulic fluids, automotive brake fluids, strong acids, ozone, freons, ketones, halogenated hydrocarbons and methonal	Nitrile-Butadiene	NBR	N0674	Black	—	70
Petroleum based oils and fluids	-15° to 400°F	Ketones, skydrol fluids, amines (VDMH), anhydrous ammonia, low molecular weight esters and ethers, hot hydrofluoric or chlorosulfuric acids	Fluorocarbon	FKM ⁵⁾ or FPM	V0747	Black	—	75
Petroleum based oils and fluids	-15° to 400°F	Ketones, skydrol fluids, amines (VDMH), anhydrous ammonia, low molecular weight esters and ethers, hot hydrofluoric or chlorosulfuric acids	Fluorocarbon	FKM ⁵⁾ or FPM	V0884	Brown ¹⁾	—	75
Petroleum based oils and fluids	-15° to 400°F	Ketones, skydrol fluids, amines (VDMH), anhydrous ammonia, low molecular weight esters and ethers, hot hydrofluoric or chlorosulfuric acids	Fluorocarbon	FKM ⁵⁾ or FPM	V0894	Brown ^{1),5)}	HK ⁴⁾	90 ⁶⁾
Petroleum based oils and fluids	-30° to 250°F	Phosphate ester base hydraulic fluids, automotive brake fluids, strong acids, ozone, freons, ketones, halogenated hydrocarbons and methonal	Nitrile-Butadiene	NBR	N0552	Black	CH ²⁾	90 ⁶⁾
Petroleum based oils and fluids	-30° to 275°F	Phosphate ester base hydraulic fluids, automotive brake fluids, strong acids, ozone, freons, ketones, halogenated hydrocarbons and methonal	Nitrile-Butadiene	NBR	N1059	Black	CH ²⁾	90
Petroleum based oils and fluids	-65° to 225°	Phosphate ester base hydraulic fluids, automotive brake fluids, strong acids, ozone, freons, ketones, halogenated hydrocarbons and methonal	Nitrile-Butadiene	NBR	N0103	Black	—	70
Phosphate ester base hydraulic fluids	-65° to 275°F	Petroleum based oils and di-ester base lubricants	Ethylene-Propylene	EPDM	E0540	Black	CA ³⁾	80
Phosphate ester base hydraulic fluids	-65° to 275°F	Petroleum based oils and di-ester base lubricants	Ethylene-Propylene	EPDM	E0893	Purple ¹⁾	CA ³⁾	80
Phosphate ester base hydraulic fluids (some)	-15° to 400°F	Ketones, skydrol fluids, amines (VDMH), anhydrous ammonia, low molecular weight esters and ethers, hot hydrofluoric or chlorosulfuric acids	Fluorocarbon	FKM ⁵⁾ or FPM	V0747	Black	—	75
Phosphate ester base hydraulic fluids (some)	-15° to 400°F	Ketones, skydrol fluids, amines (VDMH), anhydrous ammonia, low molecular weight esters and ethers, hot hydrofluoric or chlorosulfuric acids	Fluorocarbon	FKM ⁵⁾ or FPM	V0884	Brown ¹⁾	—	75
Phosphate ester base hydraulic fluids (some)	-15° to 400°F	Ketones, skydrol fluids, amines (VDMH), anhydrous ammonia, low molecular weight esters and ethers, hot hydrofluoric or chlorosulfuric acids	Fluorocarbon	FKM ⁵⁾ or FPM	V0894	Brown ^{1),5)}	HK ⁴⁾	90 ⁶⁾
Refrigerants (freons, ammonia)	-45° to 250°F	Phosphate ester fluids and ketones	Neoprene	CR	C0873	Black	—	70
Refrigerants (freons, ammonia)	-45° to 250°F	Phosphate ester fluids and ketones	Neoprene	CR	C0944	Red ¹⁾	—	70
Silicate ester lubricants	-45° to 250°F	Phosphate ester fluids and ketones	Neoprene	CR	C0873	Black	—	70
Silicate ester lubricants	-45° to 250°F	Phosphate ester fluids and ketones	Neoprene	CR	C0944	Red ¹⁾	—	70
Silicone and di-ester base lubricants	-30° to 250°	Phosphate ester base hydraulic fluids, automotive brake fluids, strong acids, ozone, freons, ketones, halogenated hydrocarbons and methonal	Nitrile-Butadiene	NBR	N0674	Black	—	70
Silicone and di-ester base lubricants	-30° to 250°F	Phosphate ester base hydraulic fluids, automotive brake fluids, strong acids, ozone, freons, ketones, halogenated hydrocarbons and methonal	Nitrile-Butadiene	NBR	N0552	Black	CH ²⁾	90 ⁶⁾
Silicone and di-ester base lubricants	-30° to 275°F	Phosphate ester base hydraulic fluids, automotive brake fluids, strong acids, ozone, freons, ketones, halogenated hydrocarbons and methonal	Nitrile-Butadiene	NBR	N1059	Black	CH ²⁾	90
Silicone and di-ester base lubricants	-65° to 225°	Phosphate ester base hydraulic fluids, automotive brake fluids, strong acids, ozone, freons, ketones, halogenated hydrocarbons and methonal	Nitrile-Butadiene	NBR	N0103	Black	—	70

Dimensions and pressures for reference only, subject to change.



Recommended for	Temperature Range	Not Recommended For	Polymer	Abbreviated Name	Parker Compound	No. Color	SAE J515 Type	Shore Hardness
Silicone and silicate ester based lubricants	-15° to 400°F	Ketones, skydrol fluids, amines (VDMH), anhydrous ammonia, low molecular weight esters and ethers, hot hydrofluoric or chlorosulfuric acids	Fluorocarbon	FKM ⁵⁾ or FPM	V0747	Black	—	75
Silicone and silicate ester based lubricants	-15° to 400°F	Ketones, skydrol fluids, amines (VDMH), anhydrous ammonia, low molecular weight esters and ethers, hot hydrofluoric or chlorosulfuric acids	Fluorocarbon	FKM ⁵⁾ or FPM	V0884	Brown ¹⁾	—	75
Silicone and silicate ester based lubricants	-15° to 400°F	Ketones, skydrol fluids, amines (VDMH), anhydrous ammonia, low molecular weight esters and ethers, hot hydrofluoric or chlorosulfuric acids	Fluorocarbon	FKM ⁵⁾ or FPM	V0894	Brown ^{1),5)}	HK ⁴⁾	90 ⁶⁾
Silicone oils and greases	-65° to 275°F	Petroleum based oils and di-ester base lubricants	Ethylene-Propylene	EPDM	E0540	Black	CA ³⁾	80
Silicone oils and greases	-65° to 275°F	Petroleum based oils and di-ester base lubricants	Ethylene-Propylene	EPDM	E0893	Purple ¹⁾	CA ³⁾	80
Steam to 400°F	-65° to 275°F	Petroleum based oils and di-ester base lubricants	Ethylene-Propylene	EPDM	E0540	Black	CA ³⁾	80
Steam to 400°F	-65° to 275°F	Petroleum based oils and di-ester base lubricants	Ethylene-Propylene	EPDM	E0893	Purple ¹⁾	CA ³⁾	80
Water under 150°F	-30° to 250°	Phosphate ester base hydraulic fluids, automotive brake fluids, strong acids, ozone, freons, ketones, halogenated hydrocarbons and methonal	Nitrile-Butadiene	NBR	N0674	Black	—	70
Water under 150°F	-30° to 250°F	Phosphate ester base hydraulic fluids, automotive brake fluids, strong acids, ozone, freons, ketones, halogenated hydrocarbons and methonal	Nitrile-Butadiene	NBR	N0552	Black	CH ²⁾	90 ⁶⁾
Water under 150°F	-30° to 275°F	Phosphate ester base hydraulic fluids, automotive brake fluids, strong acids, ozone, freons, ketones, halogenated hydrocarbons and methonal	Nitrile-Butadiene	NBR	N1059	Black	CH ²⁾	90
Water under 150°F	-65° to 225°	Phosphate ester base hydraulic fluids, automotive brake fluids, strong acids, ozone, freons, ketones, halogenated hydrocarbons and methonal	Nitrile-Butadiene	NBR	N0103	Black	—	70

Table T15 – O-Ring Selection

- 1) These Parker “Chromasure” color assurance O-Rings are available from the Parker Hannifin O-Ring Division. They help eliminate assembly errors, reduce warranty costs and liability risks, and assure safety in aftermarket business.
- 2) Formerly SAE Type I.
- 3) Formerly SAE Type II.
- 4) Formerly SAE Type III.
- 5) “FKM” is the ASTM designation for fluorocarbon. Its ISO designation is “FPM”. For “DIN” Fittings, color is green.
- 6) Standard compounds available from stock.
- 7) Use 90 durometer hard O-Rings for applications with 1500 psi or higher pressures.

Dimensions and pressures for reference only, subject to change.

Tube and Fitting Material Compatibility.....

As a general rule, tube and fitting materials should be the same. If different materials must be considered, the following chart can be used as a general guide. Since operating conditions differ with applications, this chart should be used only as a guide and not a firm recommendation.

Before making a final decision on material combination, it should be sufficiently tested under appropriate conditions to assure suitability for the intended application. For additional material combinations, contact the Tube Fittings Division.

Tube Material	Specification	Construction	Condition	Max. Hardness	Temperature Range (7)	Application	Tube Material to Fitting & Material Compatibility															
							Seal-Lok ORFS (SAE J1453)			Triple-Lok 37° Flare (SAE J514)			Ferulok Flareless (SAE J514)			Intru-Lok Flareless	EO/EO-2 Flareless (ISO 8434-1)					
							S	SS	B	S	SS	B	M	S	SS	M	B	S, SS, B				
Carbon Steel C-1010	SAE J524 (ASTM A179) (8)	Seamless	Fully Annealed	HRB 72	-65° to 500°F -55° to 260°C	High pressure hydraulic, air, & some specialty chemicals	E	NR	(6)	G	NR	(6)	NR	E	NR	NR	NR	NR	NR			
	SAE J525 (ASTM A178) (8)	Welded & Drawn					E	NR	(6)	E	NR	(6)	NR	E	NR	NR	NR	NR	NR			
	SAE J356	Welded & Flash Controlled					G	NR	(6)	NR	NR	(6)	NR	G	NR	NR	NR	NR	NR			
Carbon Steel C-1021	SAE J2467	Welded & Flash Controlled	Fully Annealed	HRB 75	-65° to 500°F -55° to 260°C	High pressure hydraulic	E	NR	(6)	NR	NR	(6)	NR	E	NR	NR	NR	NR				
	SAE J2435	Welded & Drawn					E	NR	(6)	E	NR	(6)	NR	E	NR	NR	NR	NR				
Carbon Steel High Strength Low Alloy (HSLA)	SAE 2613	Welded & Flash Controlled	Sub-critically annealed	HRB 90	-65° to 500°F -55° to 260°C	High pressure hydraulic	E	NR	(6)	NR	NR	(6)	NR	NR	NR	NR	NR	NR				
	SAE J2614	Welded & Drawn					E	NR	(6)	NR	NR	(6)	NR	NR	NR	NR	NR	NR				
Alloy Steel 4130	ASTM A519	Seamless			-65° to 500°F -55° to 260°C	High pressure hydraulics	E	NR	NR	NR	NR	NR	NR	NR	NR	NR	NR	NR				
St 37.4 (Carbon Steel)	DIN 2391 Part 2 (Metric)	Seamless	Fully Annealed	HRB 72	-65° to 500°F -55° to 260°C	High pressure hydraulic, air, & some specialty chemicals	E	NR	NR	G	NR	NR	NR	NR	NR	NR	NR	E				
Stainless Steel 304 & 316	ASTM A213 ASTM A269	Seamless	Fully Annealed	HRB 90	-425° to 1200° -255° to 650°C (3)	High pressure, high temperature, or generally corrosive media (1)	(6)	E	(6)	(6)	G	(6)	NR	(6)	E	NR	NR	NR				
	ASTM A249 ASTM A269	Welded & Drawn					(6)	E	(6)	(6)	E	(6)	NR	(6)	E	NR	NR	NR				
1.4571 1.4541 Stainless Steel	DIN 17458 Tab 8 (Metric)	Seamless	Fully Annealed	HRB 90	-425° to 1200° -255° to 650°C (3)	High pressure, high temperature, or generally corrosive media (1)	(6)	E	NR	(6)	G	NR	NR	NR	E	NR	NR	E				
Copper	SAE J528 (ASTM B-75) (8)	Seamless	Soft Annealed Temper 0	60 Max. Rockwell 15T	-325° to 400°F -200° to 205°C	Low pressure, low temperature, water, oil & air	E	(6)	E	G	(6)	E	NR	G	(2)	NR	NR	E				
Aluminum 6061	ASTM-B210	Seamless	T6 Temper	HRB 56	-325° to 400°F -200° to 205°C	Low pressure, low temperature, water, oil, air & some specialty chemicals	NR	NR	NR	G	NR	NR	NR	E	(2)	NR	NR	(6)	NR			
			0 & T4 Temper	HRB 30			E	(5)	NR	NR	G	NR	NR	NR	E	(2)	NR	NR	(6)	NR		
Monel 400	ASTM-B165	Seamless	Fully Annealed	HRB 70	-400° to 800°F -240° to 425°C	Sour gas, marine & general chemical processing media	NR	(6)	NR	NR	(6)	NR	E	NR	(6)	E	NR	NR				
Nylon		Extruded	Flexible & Semi-Rigid		-60° to 200°F -50° to 95°C	Lube lines, chemical process controls & air	NR	NR	NR	NR	NR	NR	NR	G	(2)	G	(2)	G	(2)	E	G	(2), (9)
Polyethylene	ASTM D-1248	Extruded	Instrument Grade		-80° to 150°F -60° to 65°C	Instrumentation lines	NR	NR	NR	NR	NR	NR	NR	G	(2)	G	(2)	G	(2)	E	G	(2), (9)
PVC		Extruded	Instrument & Laboratory Grade		0° to 140°F -20° to 60°C	General purpose laboratory use	NR	NR	NR	NR	NR	NR	NR	NR	NR	NR	NR	NR	G	NR	NR	
PTFE		Extruded & Cintered			-65° to 400°F -55° to 205°C	Very low pressure, high temperature, fuel, lube, chemical & air applications	NR	NR	NR	NR	NR	NR	NR	G	(2)	G	(2)	G	(2)	G	G	(2), (9)

Table T16 – Tube and Fitting Material Compatibility

Ratings Key:
 NR Not Recommended
 F Fair
 G Good
 E Excellent

Fitting Materials Code:
 S Steel
 SS Stainless Steel
 B Brass
 M Monel

Notes:

- 1) For highly corrosive media or service environment, contact the Tube Fittings Division.
- 2) Requires different assembly procedure. Contact the Tube Fittings Division.
- 3) Low temperature limit for stainless steel Ferulok fittings is -20°F (-30°C).
- 4) For brazing only. Grade 4130 not recommended with Parflange process.
- 5) For use with Parflange process only. Not recommended with brazing.
- 6) Use depends on specific application. Contact the Tube Fittings Division.
- 7) Applies to tube material.
- 8) Comparable specifications to SAE.
- 9) With metric version of tubing.
- 10) Not tested with Parflange. Contact the Tube Fittings Division.

Dimensions and pressures for reference only, subject to change.



Pressure



Fitting and Adapter Pressure Ratings

Fitting Pressure Ratings

Pressure ratings shown on the product pages of this catalog are for dynamic systems. A vast majority of systems where our fittings are used fall in this category. However, there are applications, such as hydraulic jacks, where the system pressure is essentially static once it is pressurized. For this type of an application the fittings can be used at higher pressures.

The dynamic and static systems can be defined as follows:

Dynamic: A system in which the operating pressure fluctuates, in accordance with load, up to a maximum pressure limited by the relief valve. In addition, the system may also experience shocks, vibration and temperature excursions. Example: A backhoe.

Static: A system, once pressurized, is essentially free of pressure fluctuations, shock, vibration and temperature excursions, with such pressurizations not exceeding 30,000 in the life of the system. Example: A hydraulic jack.

The dynamic pressure ratings are based on a minimum design factor of 4. In other words, the fitting is capable of holding a pressure equal to 4 times the rated pressure before leakage or failure. For static applications, the design factor can be 3. Hence, the static rating can be determined by multiplying the dynamic rating by 1.33.

Static pressure rating = 1.33 x Dynamic pressure rating

Example: Static pressure rating for a fitting rated at 6000 psi = 1.33 x 6000 = 8000 psi

Higher (dynamic) Ratings

Some parts are capable of performing at higher pressures than those shown on the product pages. For information on higher ratings, contact Tube Fittings Division.

tubing Pressure Ratings

Using Tables T20 and T21, determine the tube O.D. and wall thickness combination that satisfies the following two conditions:

- A. Has recommended design pressure equal to or higher than maximum operating pressure.
- B. Provides tube I.D. equal to or greater than required flow diameter determined earlier.

Design pressure values in Tables T20 and T21 are based on the severity of service rating "A" (design factor of 4) in Table T19, and temperature derating factor of 1 in Table T7 on page T9.

If more severe operating conditions are involved, the values in Tables T20 and T21 should be multiplied by appropriate derating factors from Tables T19 and T7 before determining the tube O.D. and wall thickness combination. Contact the Tube Fittings Division when in doubt.

Material and Type	Allowable Design Stress for Factor of 4 at 72°F	Tube Specification
Steel C1010	11,250 PSI	SAE J356, J524, J525
Steel C1021	15,000 PSI	SAE J2435, L2467
Steel, High Strength Low Alloy (HSLA)	18,000 PSI	SAE J2613, J2614
Stainless Steel 304 & 316	18,800 PSI	ASTM A213, A249, A269
Alloy Steel C4130	18,800 PSI	ASTM A519
Copper, K or Y	6,000 PSI	SAE J528, ASTM B75
Aluminum 6061-T6	10,500 PSI	ASTM B210
Monel, 400	17,500 PSI	ASTM B165

Table T17 – Design Stress Values

Design Pressure Formula (LAME'S)

$$P = S \left(\frac{d_2 - d_1}{D_2 + d_1} \right) \text{ where:}$$

D = Outside diameter of tube, in.
 d = Inside diameter of tube (D-2T), in.
 P = Recommended design pressure, psi
 S = Allowable stress for design factor of 4, psi
 T = Tube wall thickness, in.

Table T18 – Design Pressure Formula

*For thin wall tubes (D/T ≥ 10) the following formula may be Used: **P = 2ST/D**

Severity of Service	Description	Design Factor	Derating Factor
A (Normal)	Moderate mechanical and hydraulic shocks.	4.00	1.00
B (Severe)	Severe hydraulic shocks and mechanical strain.	6.00	0.67
C (Hazardous)	Hazardous application with severe service conditions.	8.00	0.50

Table T19 – Severity of Service Design and Derating Factors

Allowable design stress levels and formula used to arrive at the design pressure values are given in the following chart. Values in Table T7 are for fully annealed tubing.

The design factor is generally applied to ultimate strength of material (or burst pressure of tubing) to provide a measure of safety against the unknowns in material and operating conditions. The derating factors listed here should be applied directly to the design pressure values in Tables T20 and T21 to arrive at maximum recommended working pressures (i.e., multiply values in Tables T20 and T21 by these derating factors).

Dimensions and pressures for reference only, subject to change.

Inch Tube Pressure Ratings P

Inch Tubes*							Inch Tubes*						
Tube O.D. (in.)	Wall Thick. (in.)	Tube I.D. (in.)	Design Pressure				Tube O.D. (in.)	Wall Thick. (in.)	Tube I.D. (in.)	Design Pressure			
			Pressure C-1010	Steel C-1021	Stainless Steel 304 & 316, 4130 HSLA	Copper K or Y				Pressure C-1010	Steel C-1021	Stainless Steel 304 & 316, 4130 HSLA	Copper K or Y
0.125	0.010	0.105	1,900	2,550	3,200	1,000	0.625	0.058	0.509	2,250	3,000	3,750	1,200
0.125	0.020	0.085	4,100	5,500	6,850	2,200	0.625	0.065	0.495	2,550	3,400	4,250	1,350
0.125	0.028	0.069	5,950	7,950	9,950	3,150	0.625	0.083	0.459	3,350	4,450	5,600	1,750
0.125	0.035	0.055	7,550	10,100	12,650	4,050	0.625	0.095	0.435	3,900	5,200	6,500	2,050
0.188	0.010	0.168	1,250	1,650	2,100	650	0.625	0.109	0.407	4,500	6,050	7,550	2,400
0.188	0.020	0.148	2,600	3,500	4,400	1,400	0.625	0.120	0.385	5,050	6,700	8,400	2,700
0.188	0.028	0.132	3,800	5,050	6,350	2,000	0.625	0.134	0.357	5,700	7,600	9,500	3,000
0.188	0.035	0.118	4,850	6,500	8,150	2,600	0.750	0.035	0.680	1,050	1,450	1,800	550
0.188	0.049	0.090	7,000	9,400	11,750	3,750	0.750	0.049	0.652	1,550	2,050	2,600	800
0.250	0.020	0.210	1,900	2,550	3,200	1,000	0.750	0.058	0.634	1,850	2,450	3,100	1,000
0.250	0.028	0.194	2,750	3,700	4,650	1,450	0.750	0.065	0.620	2,100	2,800	3,500	1,100
0.250	0.035	0.180	3,350	4,750	5,900	1,900	0.750	0.083	0.584	2,750	3,650	4,550	1,450
0.250	0.049	0.152	5,150	6,900	8,600	2,750	0.750	0.095	0.560	3,150	4,250	5,300	1,700
0.250	0.058	0.134	6,200	8,300	10,350	3,300	0.750	0.109	0.532	3,700	4,950	6,150	1,950
0.250	0.065	0.120	7,000	9,350	11,700	3,750	0.750	0.120	0.510	4,100	5,500	6,850	2,200
0.250	0.083	0.084	8,950	11,950	14,900	4,750	0.750	0.134	0.482	4,650	6,200	7,750	2,450
0.313	0.020	0.273	1,500	2,000	2,500	800	0.750	0.148	0.454	5,200	6,950	8,650	2,750
0.313	0.028	0.257	2,150	2,900	3,600	1,150	0.750	0.188	0.374	6,750	9,000	11,250	3,600
0.313	0.035	0.243	2,750	3,700	4,600	1,450	0.875	0.035	0.805	900	1,200	1,550	500
0.313	0.049	0.215	4,000	5,350	6,700	2,150	0.875	0.049	0.777	1,300	1,750	2,200	700
0.313	0.058	0.197	4,850	6,450	8,100	2,550	0.875	0.058	0.759	1,550	2,100	2,600	800
0.313	0.065	0.183	5,500	7,350	9,150	2,900	0.875	0.065	0.745	1,750	2,350	2,950	950
0.313	0.083	0.147	7,150	9,550	11,950	3,800	0.875	0.083	0.709	2,300	3,100	3,850	1,200
0.313	0.095	0.123	8,200	10,950	13,700	4,350	0.875	0.095	0.685	2,650	3,600	4,500	1,400
0.375	0.020	0.335	1,250	1,650	2,100	650	0.875	0.109	0.657	3,100	4,150	5,200	1,650
0.375	0.028	0.319	1,800	2,400	3,000	950	0.875	0.120	0.635	3,450	4,650	5,800	1,850
0.375	0.035	0.305	2,250	3,050	3,800	1,200	0.875	0.134	0.607	3,900	5,250	6,550	2,100
0.375	0.049	0.277	3,300	4,400	5,500	1,750	0.875	0.148	0.579	4,350	5,850	7,300	2,300
0.375	0.058	0.259	3,950	5,300	6,600	2,100	1.000	0.035	0.930	800	1,050	1,350	400
0.375	0.065	0.245	4,500	6,000	7,500	2,400	1.000	0.049	0.902	1,150	1,500	1,900	600
0.375	0.083	0.209	5,900	7,850	9,850	3,150	1.000	0.058	0.884	1,350	1,800	2,300	700
0.375	0.095	0.185	6,800	9,100	11,400	3,650	1.000	0.065	0.870	1,550	2,050	2,550	800
0.375	0.109	0.157	7,850	10,500	13,150	4,200	1.000	0.083	0.834	2,000	2,650	3,350	1,050
0.500	0.028	0.444	1,300	1,750	2,200	700	1.000	0.095	0.810	2,300	3,100	3,850	1,200
0.500	0.035	0.430	1,650	2,200	2,800	850	1.000	0.109	0.782	2,700	3,600	4,500	1,400
0.500	0.049	0.402	2,400	3,200	4,000	1,250	1.000	0.120	0.760	3,000	4,000	5,000	1,600
0.500	0.058	0.384	2,900	3,850	4,800	1,500	1.000	0.134	0.732	3,350	4,500	5,650	1,800
0.500	0.065	0.370	3,250	4,350	5,450	1,750	1.000	0.148	0.704	3,750	5,050	6,300	2,000
0.500	0.083	0.334	4,300	5,700	7,150	2,250	1.000	0.156	0.688	4,000	5,350	6,700	2,100
0.500	0.095	0.310	4,950	6,650	8,300	2,650	1.000	0.188	0.624	4,900	6,550	8,200	2,600
0.500	0.109	0.282	5,800	7,750	9,700	3,100	1.000	0.220	0.560	5,850	7,800	9,750	3,100
0.500	0.120	0.260	6,450	8,600	10,750	3,400	1.250	0.049	1.152	900	1,200	1,500	450
0.500	0.134	0.232	7,250	9,650	12,100	3,850	1.250	0.058	1.134	1,050	1,450	1,800	550
0.500	0.148	0.204	8,000	10,700	13,350	4,250	1.250	0.065	1.120	1,200	1,600	2,050	650
0.500	0.188	0.124	9,900	13,250	16,550	5,300	1.250	0.083	1.084	1,550	2,100	2,650	800
0.625	0.028	0.569	1,050	1,400	1,750	550	1.250	0.095	1.060	1,800	2,450	3,050	950
0.625	0.035	0.555	1,300	1,750	2,200	700	1.250	0.109	1.032	2,100	2,800	3,550	1,100
0.625	0.049	0.527	1,900	1,900	1,900	1,900	1.250	0.120	1.010	2,350	3,150	3,900	1,250

Table T20 – Inch Tube Pressure Ratings
 *See Table T8 for tube specifications.

Dimensions and pressures for reference only, subject to change.



Inch Tube Pressure Ratings (cont'd.) **P**

Inch Tubes*						
Tube O.D. (in.)	Wall Thick. (in.)	Tube I.D. (in.)	Design Pressure			
			Pressure C-1010	Steel C-1021	Stainless Steel 304 & 316, 4130 HSLA	Copper K or Y
1.250	0.134	0.982	2,650	3,550	4,400	1,400
1.250	0.148	0.954	2,950	3,950	4,900	1,550
1.250	0.156	0.938	3,100	4,150	5,200	1,650
1.250	0.188	0.874	3,850	5,100	6,400	2,050
1.250	0.220	0.810	4,550	6,100	7,650	2,450
1.500	0.065	1.370	1,000	1,350	1,650	500
1.500	0.083	1.334	1,300	1,750	2,150	700
1.500	0.095	1.310	1,500	2,000	2,500	800
1.500	0.109	1.282	1,750	2,300	2,900	900
1.500	0.120	1.260	1,900	2,550	3,200	1,000
1.500	0.134	1.232	2,150	2,900	3,600	1,150
1.500	0.148	1.204	2,400	3,200	4,050	1,250
1.500	0.156	1.188	2,550	3,400	4,250	1,350
1.500	0.188	1.124	3,150	4,200	5,250	1,650
1.500	0.220	1.060	3,750	5,000	6,250	2,000
1.500	0.250	1.000	4,300	5,750	7,200	2,300
2.000	0.065	1.870	750	1,000	1,250	400
2.000	0.083	1.834	950	1,250	1,600	500
2.000	0.095	1.810	1,100	1,450	1,850	550
2.000	0.109	1.782	1,250	1,700	2,150	650
2.000	0.120	1.760	1,400	1,900	2,350	750
2.000	0.134	1.732	1,600	2,100	2,650	850
2.000	0.148	1.704	1,750	2,350	2,950	950
2.000	0.156	1.688	1,850	2,500	3,150	1,000
2.000	0.188	1.624	2,300	3,050	3,800	1,200
2.000	0.220	1.560	2,700	3,650	4,550	1,450
2.000	0.250	1.500	3,100	4,200	5,250	1,650
2.000	0.281	1.438	3,550	4,750	5,950	1,900

Table T20 – Inch Tube Pressure Ratings (cont'd.)

*See Table T6 for tube specifications.

Dimensions and pressures for reference only, subject to change.



Metric Tube Pressure Ratings..... **P**

Metric Tubes				
Tube O.D. (mm.)	Wall Thick. (mm.)	Tube I.D. (mm.)	Static Design Pressure (Bar)	
			Steel Low-Carbon St. 37-4	Stainless Steel 1.4571
4	0.5	3.0	313	
4	0.75	2.5	409	
4	1.0	2.0	522	600
5	1.0	3.0	432	
6	0.75	4.5	333	
6	1.0	4.0	389	426
6	1.5	3.0	549	600
6	2.0	2.0	692	
6	2.25	1.5	757	
8	1.0	6.0	333	368
8	1.5	5.0	431	472
8	2.0	4.0	549	
8	2.5	3.0	658	
10	1.0	8.0	282	294
10	1.5	7.0	373	389
10	2.0	6.0	478	498
10	2.5	5.0	576	
10	3.0	4.0	666	
12	1.0	10.0	235	245
12	1.5	9.0	353	368
12	2.0	8.0	409	426
12	2.5	7.0	495	
12	3.0	6.0	576	
12	3.5	5.0	651	
14	1.5	11.0	302	315
14	2.0	10.0	357	420
14	2.5	9.0	434	452
14	3.0	8.0	507	
14	3.5	7.0	576	
14	4.0	6.0	641	
15	1.0	13.0	188	196
15	1.5	12.0	282	294
15	2.0	11.0	336	392
15	3.0	9.0	478	
16	1.5	13.0	264	276
16	2.0	12.0	353	368
16	2.5	11.0	386	403
16	3.0	10.0	452	472
18	1.0	16.0	157	
18	1.5	15.0	235	245
18	2.0	14.0	313	327
18	2.5	13.0	392	
18	3.0	12.0	409	
20	1.5	17.0	212	
20	2.0	16.0	282	294
20	2.5	15.0	353	368
20	3.0	14.0	373	389
20	3.5	13.0	426	
20	4.0	12.0	478	
22	1.5	19.0	192	200
22	2.0	18.0	256	267
22	2.5	17.0	320	
22	3.0	16.0	343	
25	2.0	21.0	226	
25	2.5	20.0	282	294
25	3.0	19.0	338	353

Metric Tubes				
Tube O.D. (mm.)	Wall Thick. (mm.)	Tube I.D. (mm.)	Static Design Pressure (Bar)	
			Steel Low-Carbon St. 37-4	Stainless Steel 1.4571
25	4.0	17.0	394	
25	4.5	16.0	437	
25	5.0	15.0	478	
28	1.5	25.0	151	158
28	2.0	24.0	201	210
28	2.5	23.0	252	
28	3.0	22.0	302	
30	2.0	26.0	188	
30	2.5	25.0	235	245
30	3.0	24.0	282	294
30	4.0	22.0	336	392
30	5.0	20.0	409	
35	2.0	31.0	161	168
35	2.5	30.0	201	
35	3.0	29.0	242	
35	4.0	27.0	322	
38	2.5	33.0	186	
38	3.0	32.0	223	
38	4.0	30.0	297	309
38	5.0	28.0	332	
38	6.0	26.0	390	
38	7.0	24.0	446	
42	2.0	38.0	134	140
42	3.0	36.0	201	210
42	4.0	34.0	269	
50	6.0	38.0	338	
50	9.0	32.0	437	
65	8.0	49.0	347	

Table T21 – Metric Tube Pressure Ratings

Dimensions and pressures for reference only, subject to change.





Tube Selection Example

To select tube material and tube sizes for pressure, return and suction lines for a hydraulic power unit with the following operating parameters known:

Type of fluid: Petroleum base hydraulic fluid

Operating temperature range: -20°F to +140°F.

Maximum operating pressure: 3500 psi

Maximum flow rate through each line: 10 GPM

Severity of service: A (normal)

1. Selecting Tube Material: Table T6 indicates that carbon steel, C-1010, tubing would meet the media, operating temperature range, and maximum operating pressure (high) requirements.

2. Sizing the Tube: From Table T1, the recommended flow diameters for various lines for 10 GPM flow rate are: 0.405 for pressure line, 0.639 for return line, and 1.012 for suction line.

Now, using Tables T20 and T21, we need to find tubes with inside diameters (I.D.) equal to or larger than the above flow diameters, and wall thicknesses appropriate for design pressures of 3500 psi minimum for the pressure line and about 500 psi for return and suction lines. Since derating factors for Severity of Service (Table T19) and Max. Operating Temperature (Table T7) are both 1, design pressure values in Tables T20 and T21 do not need to be reduced. Matching tube I.D.s and design pressures in Tables T15 and T16 for above conditions, we find:

- A) For the pressure line, we would choose 5/8" O.D. x .083" wall tubing. The .095" and .109" wall tubes would also be satisfactory if .083" wall is not readily available.
- B) For the return line, either 3/4" x .035" or 3/4" x .049" would meet the requirements. If Ferulok fittings are being used, we will need to go to 3/4" x .065" because .065" is the smallest wall thickness recommended for 3/4" O.D. tubing used with Ferulok fittings in Table T22. This reduces the flow diameter about 3% below the recommended value, but is still in the acceptable range. The alternative is to go to 7/8" O.D. x .072" wall tubing, which is way too large.
- C) For the suction line, we can use any one of the following tubes: 1-1/4" O.D. x .049" to .083" wall tube for Triple-Lok or Seal-Lok fittings and 1-1/4" O.D. x .095" wall tube for Ferulok fittings.

One final consideration in choosing the right wall thickness for tubing is bending. If bending without the use of a mandrel is desired, then wall thickness of less than 7% of tube O.D. should not be used.

Tube Material			Steel St. Steel Copper Aluminum	Steel St. Steel Monel	Steel Alloy Steel St. Steel Copper Monel	Copper Aluminum Plastics	Steel St. Steel
Size			SAE 37° Flare Triple-Lok	SAE Flareless Ferulok	SAE O-Ring Face Seal Seal-Lok	Intru-Lok	Metric Flareless
O.D. (in.)	O.D. (mm)	Dash #					
1/8	4	-2	.010 - .035	.010 - .035	—	.012 - .028	0.5 - 1
3/16	6	-3	.010 - .035	.020 - .049	—	.012 - .035	1 - 2
1/4	8	-4	.020 - .065	.028 - .065	.020 - .083	.020 - .049	1 - 2.5
5/16	10	-5	.020 - .065	.028 - .065	.020 - .095	.020 - .065	1 - 3
3/8	12	-6	.020 - .065	.035 - .095	.020 - .109	.028 - .065	1.5 - 3.5
1/2	14	-8	.028 - .083	.049 - .120	.028 - .148	.035 - .083	1.5 - 4
5/8	15	-10	.035 - .095	.058 - .120	.035 - .134	.035 - .083	1.5 - 4
3/4	16	-12	.035 - .109	.065 - .120	.035 - .148	.035 - .095	2 - 4
7/8	18	-14	.035 - .109	.072 - .120	—	.049 - .095	2 - 4
1	20	-16	.035 - .120	.083 - .148	.035 - .188	.049 - .120	2.5 - 4
1 1/4	22	-20	.049 - .120	.095 - .188	.049 - .220		2.5 - 4
1 1/2	25	-24	.049 - .120	.095 - .220	.049 - .250		2.5 - 4.5
2	28	-32	.058 - .134	.095 - .220	.065 - .220		2.5 - 4.5
	30						2.5 - 5
	35						3 - 5
	38						3 - 6
	42						3.5 - 7

1) Brazing to attach sleeve can be used for all wall thicknesses. For flanging tool availability, see page R24.

Table T22 – Recommended “Min./Max” Tube Wall Thickness for Common Fittings

Dimensions and pressures for reference only, subject to change.



How to Order Seal-Lok, Triple-Lok, Ferulok, Intru-Lok, JIS and K4

TFD Standard Nomenclature Construction

Box 1	Box 2	Box 3	Box 4	Box 5	Box 6
Size	Shape or Style	Sub-Style	Type	Material	Plating Options
1 to 4 sets of numbers from Box 1	Letter code from Box 2	Number/Letter code from Box 3	Number/Letter code from Box 4	Letter code from Box 5	Letter code from Box 6

Example: Steel Seal-Lok Adjustable Elbow Connector — 3/8" O.D. (-6) Tube to 7/16-20 UNF (-4) ORB = 6-4 C5L-S

(See the shading in the boxes below for the construction of this example)

Tube End		Port End		Port End	
Dash Size	Tube O.D.	Dash Size	SAE Straight Thread	Dash Size	NPTF Pipe Thread
-2	1/8	-2	5/16-24	-2	1/8
-3	3/16	-3	3/8-24	-2	1/8
-4	1/4	-4	7/16-20	-2	1/8
-5	5/16	-5	1/2-20	-2	1/8
-6	3/8	-6	9/16-18	-4	1/4
-8	1/2	-8	3/4-16	-6	3/8
-10	5/8	-10	7/8-14	-8	1/2
-12	3/4	-12	1 1/16-12	-12	3/4
-14	7/8	-14	1 3/16-12	-12	3/4
-16	1	-16	1 5/16-12	-16	1
-20	1 1/4	-20	1 5/8-12	-20	1 1/4
-24	1 1/2	-24	1 7/8-12	-24	1 1/2
-32	2	-32	2 1/2-12	-32	2

Straights		90° Elbows	
B	Nut	C*	Male Elbow Connector
F*	Male Connector	CC*	Long Male Elbow
FF*	Long Male Connector or Pipe Nipple	CCC*	Extra Long Male Elbow
FFF*	Extra Long Male Connector or Pipe Nipple	D	Female Elbow
FN	Cap	E	Union Elbow
G*	Female Connector	WE	Bulkhead Union Elbow
H	Union	45° Elbows	
HH	Long Union	N	Union Elbow
HPN*	Plug, Straight Thread, Hollow Hex	V*	Male Elbow Connector
LH	Large Hex Union	WN	Bulkhead Union Elbow
PN*	Plug, Straight Thread, Hex Head	Tees	
T	Sleeve or Ferrule	J	Union Tee
TP	Sleeve, Parflange	M	Female Run Tee
TR	Tube Reducer	O	Female Branch Tee
T22	Mountie	R*	Male Run Tee
W	Bulkhead Union	S*	Male Branch Tee
WF	Bulkhead Male	WJ	Bulkhead Branch Tee
WG	Bulkhead Female	WJJ	Bulkhead Run Tee
WLN	Bulkhead Locknut for Triple-Lok, Ferulok, and Intru-Lok	Cross	
WLNL	Bulkhead Locknut for Seal-Lok	K	Union Cross

Connectors (a)	
3	BSPT Port End
4**	BSPP Port End, O-Ring & RR
5**	SAE Straight Thread Port End
8**	Metric Port End, O-Ring & RR
9	SAE-ORB with Metal Seal
42	BSPP Port End, "ED" Seal
47**	BSPP O-Ring Port, B2351
82	Metric Port End, "ED" Seal
87**	ISO 6149 Port End
J4 (e)	Banjo Connection, BSPP, Soft Seal
J8 (e)	Banjo Connection, Metric, Soft Seal
Swivel Unions (b)	
6	Female Swivel
Swivel Connectors (c)	
63	BSPT Port, Swivel Connector
64**	BSPP Port, Swivel Connector
642	BSPP, "ED" Seal, Swivel Connector
65**	SAE-ORB, Swivel Connector
68**	Metric Port, Swivel Connector
682	Metric Port, Swivel Connector
687**	ISO 6149, Swivel Connector
Straight Thread Plugs (d) (Modifiers for P)	
4, 5, 8, 9 and 87 as in Connectors above.	
Notes	
a. Modifiers for Connectors as noted with asterisk in Box 2.	
b. Modifier for C, V, R, S, H, E and J in Box 2.	
c. Modifiers for F only in Box 2.	
d. Modifiers for P only in PN and HPN in Box 2.	
e. Applies to 90° elbows and tees only.	

I	Intru-Lok
K4	60° Cone BSPP
L**	Seal-Lok
P4	JIS 60° Cone
T4	JIS 30° Flare
U	Ferulok
X	Triple-Lok

B	Brass
CUNI	Cupro-Nickel (ex. CUNI 70/30)
D	Dural (Aluminum)
M	Monel
S	Steel w/ zinc plating
SS	Stainless Steel. 316/316L passivated

ZJ	Parker XTR Plating
----	--------------------

**Placing the letter "O" after these sub-style modifiers and fitting types will indicate that you would like an O-Ring on that corresponding end.

Dimensions and pressures for reference only, subject to change.



How to Order 4-Bolt Hydraulic Flanges

TFD Standard Nomenclature Construction

Box 1	Box 2	Box 3	Box 4	Box 5	Box 6	Box 7
Flange Size	Connection Description	Shape	Flange Connection Type	Mounting Style	Material	Kit Designation

Box 1 – Port/Tube/Pipe Flange Size

Symbol	Description
One-to-two digit codes	Size in inches x 16

One code is required if end connections are the same size. Two codes are required if they are different sizes (e.g., 16-12).

Box 2 – Port/Tube/Pipe Connection Description

Symbol	Description
B3	Braze Socket – silver braze
CP1	Connector Plate – Code 61
CP2	Connector Plate – Code 62
FCC1	Flange Clamp, Captive – Code 61
FCC2	Flange Clamp, Captive – Code 62
FCCT1	Flange Clamp, Captive with Tapped Holes – Code 61
FCCT2	Flange Clamp, Captive with Tapped Holes – Code 62
FCS1	Flange Clamp, Split – Code 61
FCS2	Flange Clamp, Split – Code 62
G	NPTF Port
G3	BSPT Port
G4	BSPP Port
G5	SAE Port
P	Plug (blanking end)
SP	Spacer w/o Gage Ports
SPG	Spacer w/ 1/4-18 NPTF Gage Port
SPG5	Spacer w/ 7/16-20 UNF Gage Port
SPGG5	Spacer w/ 1/4-18 NPTF & 7/16-20 UNF Ports
WSD1	Weld Saddle – Pipe
WSD2	Weld Saddle – Tube
W4	Flat Weld Socket – Tube
W4S	Flat Weld Socket – Tube (shallow)
W5	Flat Weld Socket – Pipe
W5S	Flat Weld Socket – Pipe (shallow)
W6	Extended Weld Socket – Tube
W6S	Extended Weld Socket – Tube (shallow)
W7	Extended Weld Socket – Pipe
W7S	Extended Weld Socket – Pipe (shallow)
WB1	Weld Butt – Schedule 40
WB3	Weld Butt – Schedule 80
WB5	Weld Butt – Schedule 160
WB7	Weld Butt – Schedule XXS
WBT	Weld Butt – Tank Pilot
WPL	Weld Plate
W	Weld Socket
W2	Weld Nipple
W3 or WB	Weld Nipple – Weld Butt, Tube

Box 3 – Shape Description

Symbol	Description
None	Block and Pad, Straight*
E	Elbow 90°
H	Barstock, Straight
J	Tee

*The “Block” has O-Ring and drilled mounting holes, while the “Pad” has no O-Ring groove and tapped mounting holes.

Box 4 – Flange Connection Type

Symbol	Description
Q1	Code 61 Flange Head w/ O-Ring Groove
Q1N	Code 61 Flange Head w/o O-Ring Groove
Q2	Code 62 Flange Head w/ O-Ring Groove
Q2N	Code 62 Flange Head w/o O-Ring Groove
Q1B	Code 61 Flange Block w/ O-Ring Groove and Drilled Mounting Holes
Q1P	Code 61 Flange Block w/o O-Ring Groove and Drilled Mounting Holes
Q2B	Code 62 Flange Block w/ O-Ring Groove and Drilled Mounting Holes
Q2P	Code 62 Flange Pad w/o O-Ring Groove and Tapped Mounting Holes
QSB	Square Flange Block w/ O-Ring Groove and Drilled Mounting Holes
QSP	Square Flange Pad w/o O-Ring Groove and Tapped Mounting Holes

Box 5 – Mounting Style

Symbol	Description
Omit	Inch Mounting Bolts (screws)
M	Metric Mounting Bolts (screws)

Box 6 – Material

Symbol	Description
S	Steel, Zinc Plated (braze or weld parts may not be plated)
SX	Steel, Oil Dipped
SS	Stainless Steel

Box 7 – Kit Designation

Symbol	Description
Omit	Flange Only
M	Kit (O-Ring, 4 bolts and washers)

Dimensions and pressures for reference only, subject to change.

How to Order EO and EO-2 Fittings and Accessories

TFD Standard Nomenclature Construction

Box 1	Box 2	Box 3	Box 4	Box 5	Box 6	Box 7	Box 8	Box 9
Shape/Style	Tube Size (mm.)	EO-2 Designator	Pressure Series	Port Size/ Designator	Port Sealing Method Modifier	Modifier 1	Material	Modifier 2

Box 1 – Shape/Style Code			
Straights		Tees	
AS	Weld Connector	EL	Swivel Nut Run
AS_ /	Weld Flange	ET	Swivel Nut Branch
BFG	Square Flange Connector	GMA1/	Union w/ Test Point, Pin
DA	Distance Adapter	GMA3/	Union w/ Test Point, M16x2
DG101/	Rotary Union	LEE	Adjustable Run
DG102/	Rotary Connector	T	Union
DG107/	Rotary Bulkhead Union	TEE	Adjustable Branch
DVGE	Plain Bearing Rotary	TH	High Pressure Banjo
EGE	Swivel Nut Connector	TR	Reducer Union
EGEO	ISO 6149 Swivel Nut Connector	WV	Alternating Valve
ESV	Weld Bulkhead Union	Cross	
G	Union	K	Union
GAI	Female Connector	Accessories	
GE	Male Connector	D	Cutting Ring
GEO	ISO 6149 Connector	DKA	Metal Seal Ring
GFS_ /	Flange Connector	DKI	Pressure Gage Seal
GR	Reducer Union	DOZ	EO-2 Seal Ring
GZ	Swivel Union	DPR	Progressive Ring
GZR	Reducer Swivel Union	E	Insert
MAV	Gage Connector	ED	EOlastic Seal
MAVE	Swivel Nut Gage Connector	FM	EO-2 Functional Nut
RED	Tube End Reducer	GM	Bulkhead Locknut
SKA	Weld Adapter	KD	Plastic Seal
SV	Bulkhead Union	KDS	Elastomeric Seal
VKA1/	Test Point Connector, Pin	M	Tube Nut
VKA3/	Test Point Connector, M16x2	OR	O-Ring
90° Elbows		PSR	Progressive Ring (new)
BFW	Square Flange Connector	R	Tube
DG103/	Rotary Union	ROV	Plug
DG104/	Rotary Connector	VH	Insert
DG108/	Rotary Bulkhead Union	VKA	Cap
DVWE	Plain Bearing Rotary	VSTI	Hollow Hex Plug
EW	Swivel Nut	Valves	
SWVE	Banjo	RHD	Union Check
W	Union	RHV	Connector Check
WAS	Weld Connector	RHZ	Connector Check
WE	Male Connector	RHDI	Female Check
WEE	Adjustable	RVP	Cartridge Check
WFS_ /	Flange Connector	DV	Low Pressure Shut Off
WH	High Pressure Banjo	LD	Medium Pressure Shut Off
WSV	Bulkhead Union	VDHA	High Pressure Shut Off
Double 90° Elbows		VDHB	High Pressure Shut Off
DG105/	Rotary Union	KH	2-way Ball Valve
DG106/	Rotary Connector	KH3/2-	3-way Ball Valve
45° Elbows		WV	Alternating Union Tee
EV	Swivel Nut		
VEE	Adjustable		

Box 2 – Tube Size (mm.)
04
05
06
08
10
12
14
15
16
18
20
22
25
28
30
35
38
42

Box 3 – EO-2 Designator	
Z	EO-2 Assy.

Box 4 – Pressure Series	
LL	Very Light
L	Light
S	Heavy

Box 5 – Port Size/ Designator (optional)	
Metric	
M_	Metric Parallel
M_X_	Metric Parallel (Jump Size)
M_X_keg	Metric Taper
NPT – Inch	
1/8NPT	NPT Thread
1/4NPT	NPT Thread
3/8NPT	NPT Thread
1/2NPT	NPT Thread
3/4NPT	NPT Thread
1NPT	NPT Thread
1 1/3NPT	NPT Thread
1 1/2NPT	NPT Thread
SAE-ORB	
7/16UNF	Inch Parallel Thread
9/16UNF	Inch Parallel Thread
3/4UNF	Inch Parallel Thread
3/4UNF	Inch Parallel Thread
7/8UNF	Inch Parallel Thread
11/16UNF	Inch Parallel Thread
15/16UNF	Inch Parallel Thread
1 5/8UNF	Inch Parallel Thread
1 7/8UNF	
BSPP/BSPT	
R_	BSPP
R_/_keg	BSPT

Box 6 – Port Sealing Method Modifier (optional)	
ED	EOlastic Seal
OR	ISO 6149 O-Ring
Kds	Banjo Seal Ring

Box 7 – Modifier 1 (optional)	
OMD	Without Nut and Sleeve
VIT	FPM (omitted for Stainless)
NBR	Nitrile Seals (omitted for Steel and Brass)
_ _ B	Special Cracking Pressure (check valve)

Box 8 – Material	
CF	Chromium 6 Free
MS	Brass
71	Stainless Steel
VZ	Zinc Plated (tube only)

Box 9 – Modifier 2 (optional)	
X	Unassembled

Dimensions and pressures for reference only, subject to change.



ISO 6149-1 – Metric Straight Thread O-Ring Port

(SAE 2244-1/DIN 3852, Part 3) Metric ISO 261, “M” Thread

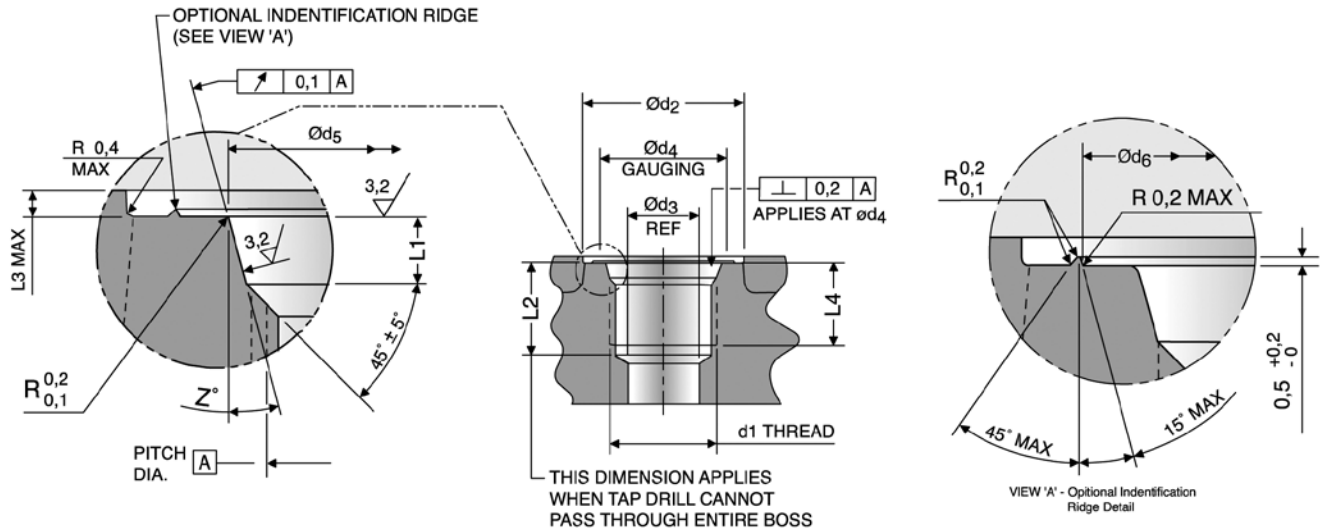

Thread Size	Large d2 ²⁾	Small d2 ³⁾	d3 ⁴⁾	d4	d5	d6	L1	L ²⁾	L3	L4	Z°	Parker O-Ring Size ⁶⁾
d1 ¹⁾	min	min.	ref.		+0.1 0	+0.5 0	+0.4 0	min.	max	min. full thread	±1°	
M8 X 1	17	14	3	12.5	9.1	14	1.6	11.5	1	10	12°	M8 ISO O-Ring
M10 X 1	20	16	4.5	14.5	11.1	16	1.6	11.5	1	10	12°	M10 ISO O-Ring
M12 X 1.5	23	19	6	17.5	13.8	19	2.4	14	1.5	11.5	15°	M12 ISO O-Ring
M14 X 1.56)	25	21	7.5	19.5	15.8	21	2.4	14	1.5	11.5	15°	M14 ISO O-Ring
M16 X 1.5	28	24	9	22.5	17.8	24	2.4	15.5	1.5	13	15°	M16 ISO O-Ring
M18 X 1.5	30	26	11	24.5	19.8	26	2.4	17	2	14.5	15°	M18 ISO O-Ring
M22 X 1.5	33	29	14	27.5	23.8	29	2.4	18	2	15.5	15°	M22 ISO O-Ring
M27 X 2	40	34	18	32.5	29.4	34	3.1	22	2	19	15°	M27 ISO O-Ring
M30 X 2	44	38	21	36.5	32.4	38	3.1	22	2	19	15°	M30 ISO O-Ring
M33 X 2	49	43	23	41.5	35.4	43	3.1	22	2.5	19	15°	M33 ISO O-Ring
M42 X 2	58	52	30	50.5	44.4	52	3.1	22.5	2.5	19.5	15°	M42 ISO O-Ring
M48 X 2	63	57	36	55.5	50.4	57	3.1	25	2.5	22	15°	M48 ISO O-Ring
M60 X 2	74	67	44	65.5	62.4	67	3.1	27.5	2.5	24.5	15°	M60 ISO O-Ring

FOR CARTRIDGE VALVE CAVITIES ONLY (SEE ISO 7789)

M20X1.5 ⁷⁾	32	27	--	25.5	21.8	27	2.4	--	2	14.5	15°	M20 ISO O-Ring
-----------------------	----	----	----	------	------	----	-----	----	---	------	-----	----------------

Table T23 – Port Detail – ISO 6149-1

- 1) Per ISO 261 tolerance class 6H. Tap drill per ISO 2306 class 6H.
- 2) Spotface diameter with the optional identification ridge.
- 3) Spotface diameter without identification ridge. Port to be identified by marking “metric” next to it or “ISO 6149-1 Metric” on component name plate.
- 4) Reference only. Connecting hole application may require a different size.
- 5) Tap drill depths given require use of a bottoming tap to produce the specified full thread lengths. Where standard taps are used, increase tap drill depths accordingly.
- 6) Preferred for diagnostic port applications.
- 7) For cartridge valve cavity applications only.
- 8) 90 durometer nitrile is standard for hydraulic applications.

NOTE: For port tapping tools, see pages R34 and R35. See page S6 for assembly torques.

Dimensions and pressures for reference only, subject to change.



SAE J1926-1 – SAE Straight Thread O-Ring Port (ISO 11926-1)

(Conforms to MS16142. Does NOT conform to MS33649⁽⁸⁾.)

UN/UNF Threads

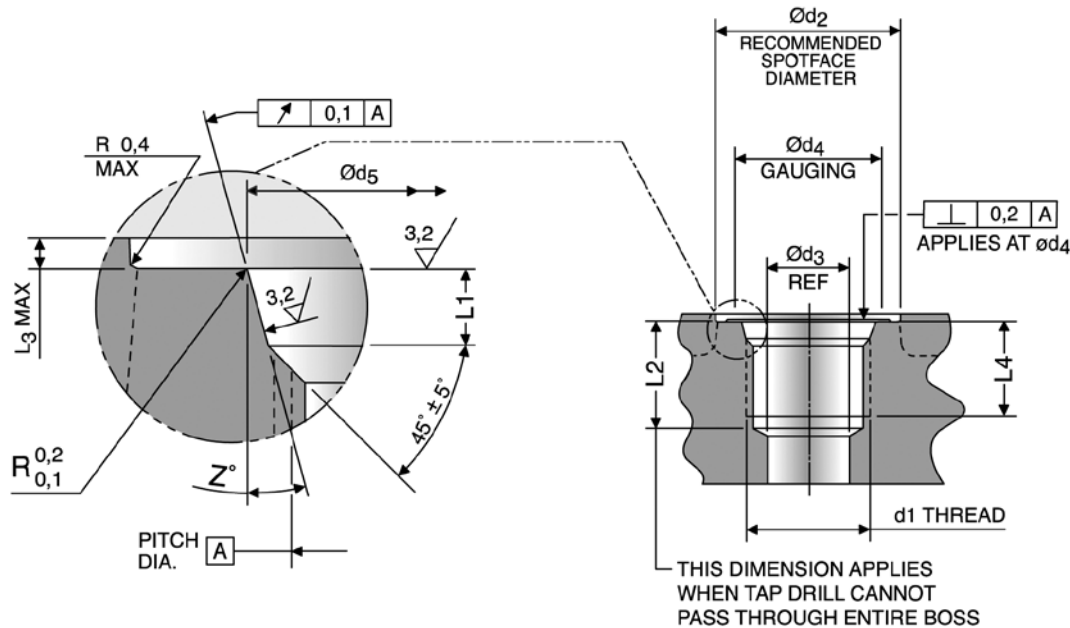

Nominal Tube OD ¹⁾			Thread Size ANSI B1.1 (ISO 263) (in.)	d2 dia. ³⁾ (mm.)	d3 dia. min. (mm.)	d4 dia. min. (mm.)	d5 dia. ⁴⁾ +0.13 -0.00 (mm.)	L1 +0.4 -0.00 (mm.)	L2 ⁵⁾ min. (mm.)	L3 ^{3), 6)} min. (mm.)	L4 Full Thread min. (mm.)	Z ±1° deg.	Parker O-Ring Size ⁷⁾
Nom ²⁾ SAE Dash Size	Inch (in.)	Metric (mm.)											
-2	1/8	---	5/16-24 UNF-2B	17	1.6	11	9.1	1.9	12.0	1.6	10.0	12°	3-902
-3	3/16	4	3/8-24 UNF-2B	19	3.2	13	10.7	1.9	12.0	1.6	10.0	12°	3-903
-4	1/4	6	7/16-20 UNF-2B	21	4.4	15	12.4	2.4	14.0	1.6	11.5	12°	3-904
-5	5/16	8	1/2-20 UNF-2B	23	6.0	16	14.0	2.4	14.0	1.6	11.5	12°	3-905
-6	3/8	10	9/16-18 UNF-2B	25	7.5	18	15.6	2.5	15.5	1.6	12.7	12°	3-906
-8	1/2	12	3/4-16 UNF-2B	30	10.0	22	20.6	2.5	17.5	2.4	14.3	15°	3-908
-10	5/8	14, 15, 16	7/8-14 UNF-2B	34	12.5	26	23.9	2.5	20.0	2.4	16.7	15°	3-910
-12	3/4	18, 20	1 1/16-12 UN-2B	41	16.0	32	29.2	3.3	23.0	2.4	19.0	15°	3-912
-14	7/8	22	1 3/16-12 UN-2B	45	18.0	35	32.3	3.3	23.0	2.4	19.0	15°	3-914
-16	1	25, 28	1 5/16-12 UN-2B	49	21.0	38	35.5	3.3	23.0	3.2	19.0	15°	3-916
-20	1 1/4	30, 32, 35	1 5/8-12 UN-2B	58	27.0	48	43.5	3.3	23.0	3.2	19.0	15°	3-920
-24	1 1/2	38, 42	1 7/8-12 UN-2B	65	33.0	54	49.8	3.3	23.0	3.2	19.0	15°	3-924
-32	2	50	2 1/2-12 UN-2B	88	45.0	70	65.7	3.3	23.0	3.2	19.0	15°	3-932

Table T24 – Port Detail – SAE J1926-1 (ISO 11926-1)

- Nominal tube OD is shown for the standard inch sizes and the conversion to equivalent millimeter sizes. Figures are for reference only, as any boss can be used for a tubing size depending upon other design criteria.
- See SAE J846 for more information.
- If face of boss is on a machined surface, dimensions d2 and L3 need not apply as long as corner radius R0.2 is maintained.
- Diameter d5 shall be concentric with thread pitch diameter within 0.004 in (0.1mm) FIM, and shall be free from longitudinal and spiral tool marks. Annular tool marks up to 100 µin (2.5µm) max. shall be permissible.
- Tap drill depths given require use of bottoming taps to produce the specified full thread lengths. Where standard taps are used, the tap drill depths must be increased accordingly.
- Maximum recommended spotface depth to permit sufficient wrench grip for proper tightening of the fitting or locknut.
- 90 durometer nitrile is standard for hydraulic applications.
- See page T34.

NOTE: For port tapping tools, see pages R32 and R33. For assembly torques see page S5.

Dimensions and pressures for reference only, subject to change.

SAE Straight Thread Connector Use in MS33649

SAE straight thread connectors, such as Parker F50X, need a special hex chamfer of 35° to a controlled diameter to function properly in MS33649 port. In the past, when MS33649 was more popular, Parker fittings were made with this chamfer. However, this port has been superseded by SAE J1926-1 in industrial applications for over 50 years.

Since J1926-1 is a superior design, Parker, along with other manufacturers, discourages the use of MS33649 port in non aircraft applications. In fact, a chamfer modification requirement for MS33649 will not be in the next printing of the SAE J514 specification, again to discourage the use of this port.

If you must use this port, you have to request fittings with this special chamfer requirement, which makes them special and more expensive.

ISO 6162 – Four-Bolt Flange Connection (Includes SAE J518)

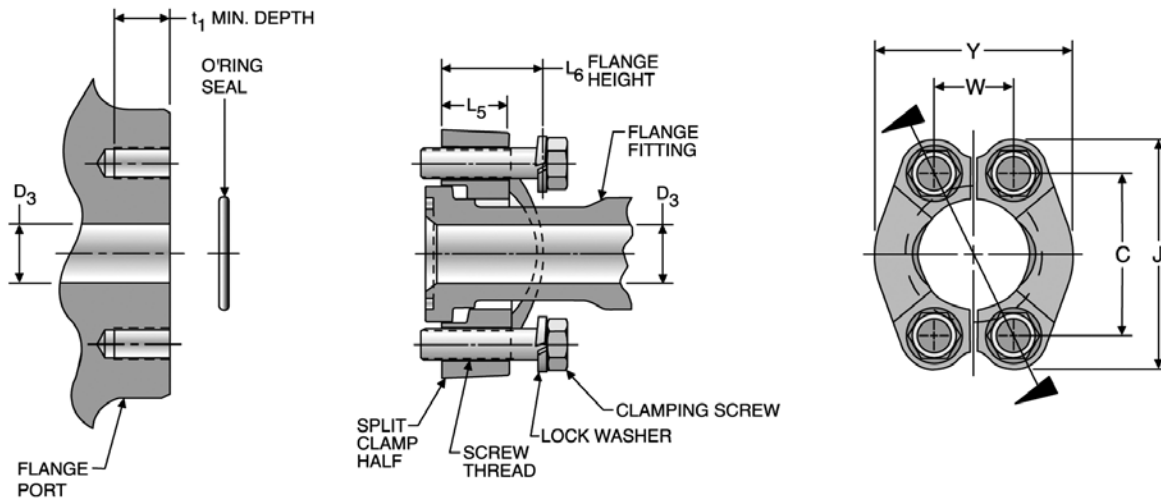

Nominal Flange Size D3		2.5 to 31.5 MPa Series ¹⁾ (SAE Code 61)											O-Rings ³⁾	
		Clamping Screws Screw Holes				Flange Half and Bolt Pattern							ISO 3601-1 ID x Section	Parker O-Ring Size
		Type I		Type II ²⁾ (SAE J518)		C ± 0.25	J		W ± 0.25	Y Ref.	L5	L6		
(in.)	(mm.)	Thread	t, Min. depth	Thread (UNC)	t, Min. depth		max.	min.						
1/2	13	M8 x 1.5	12.5	5/16 - 18	24	38.1	54.9	53.1	17.5	46	13	19	19 x 3.55	2-210
3/4	19	M10 x 1.5	16.5	3/8 - 16	22	47.6	65.8	64.3	22.3	52	14	22	25 x 3.55	2-214
1	25	M10 x 1.5	14.5	3/8 - 16	22	52.4	70.6	69.1	26.2	59	16	22	32.5 x 3.55	2-219
1 1/4	32	M10 x 1.5	16.5	7/16 - 14	28	58.7	80.3	78.5	30.2	73	14 ⁴⁾	24	37.5 x 3.55	2-222
1 1/2	38	M12 x 1.75	19.5	1/2 - 13	27	69.9	94.5	93.0	35.7	83	16	25	47.5 x 3.55	2-225
2	51	M12 x 1.75	19.5	1/2 - 13	27	77.8	103.1	100.1	42.9	97	16	26	56 x 3.55	2-228
2 1/2	64	M12 x 1.75	21.5	1/2 - 13	30	88.9	115.8	112.8	50.8	109	19	38	69 x 3.55	2-232
3	76	M16 x 2	28.5	5/8 - 11	30	106.4	136.7	133.4	61.9	131	22	41	85 x 3.55	2-237
3 1/2	89	M16 x 2	28.5	5/8 - 11	33	120.7	153.9	150.9	69.9	140	22	28	97.5 x 3.55	2-241
4	102	M16 x 2	25.5	5/8 - 11	30	130.2	163.6	160.3	77.8	152	25	35	112 x 3.55	2-245
5	127	M16 x 2	27.5	5/8 - 11	33	152.4	182.6	185.7	92.1	181	28	41	136 x 3.55	2-253

Nominal Flange Size D3		40 MPa Series ¹⁾ (SAE Code 62)											O-Rings ³⁾	
		Clamping Screws Screw Holes				Flange Half and Bolt Pattern							ISO 3601-1 ID x Section	Parker O-Ring Size
		Type I		Type II ²⁾ (SAE J518)		C ± 0.25	J		W ± 0.25	Y Ref.	L5	L6		
(in.)	(mm.)	Thread	t, Min. depth	Thread (UNC)	t, Min. depth		max.	min.						
1/2	13	M8 x 1.5	14.5	5/16 - 18	21	38.1	57.2	55.6	18.2	48	16	22	19 x 3.55	2-210
3/4	19	M10 x 1.5	16.5	3/8 - 16	24	47.6	72.1	70.6	23.8	60	19	28	25 x 3.55	2-214
1	25	M12 x 1.75	21.5	7/16 - 14	27	52.4	81.8	80.3	27.8	70	24	33	32.5 x 3.55	2-219
1 1/4	32	M12 x 1.75	18.5	1/2 - 13	25	58.7	96.0	94.5	31.8	78	27	38	37.5 x 3.55	2-222
1 1/2	38	M16 x 2	25.5	5/8 - 11	35	69.9	114.3	111.3	36.5	95	30	43	47.5 x 3.55	2-225
2	51	M20 x 2.5	33.5	3/4 - 10	38	77.8	134.9	131.8	44.5	114	37	52	56 x 3.55	2-228

Table T25 – Port Detail – ISO 6162

- 1) 1 MPa = 10 bar = 145 PSI.
- 2) Not for new design.
- 3) 90 durometer nitrile is standard for hydraulic applications.

NOTE: For port tapping tools, see pages R32 and R33. See page S8 for assembly torques.

Dimensions and pressures for reference only, subject to change.



ISO 1179-1¹⁾ — Flat Face Port with British Standard Pipe, Parallel (BSP) Threads

(DIN 3852, Part 2)

ISO 228-1, “G” Threads

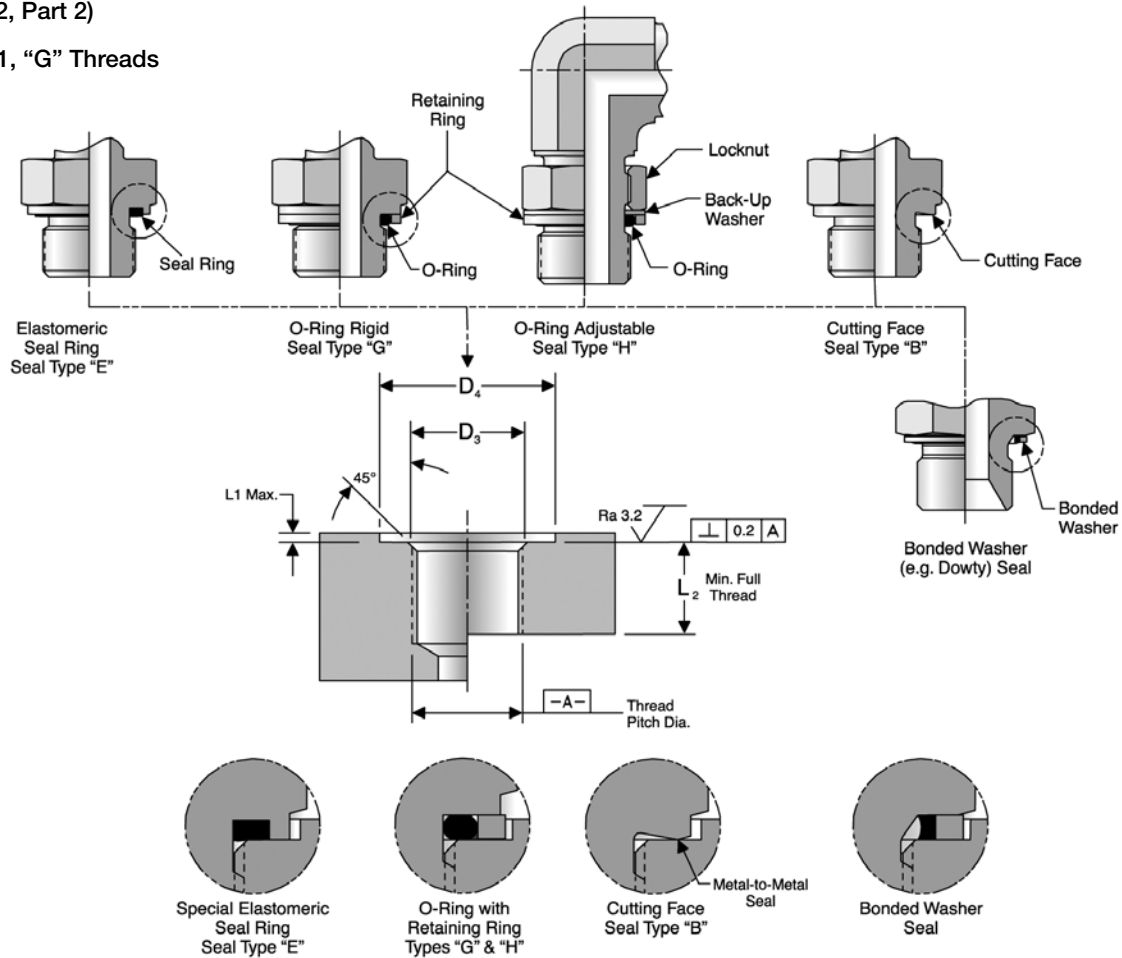

Port Sealing Methods

Thread Size (ISO 228-1)	D3 (mm.)	D4 (mm.)		L1 max. (mm.)	L2 min. (mm.)	Elastic Seal (Type E)		O-Ring and Retaining Ring ³⁾ (Types G & H)		Bonded Washer Part No. ⁴⁾
		Narrow Types B & E	Wide Types G & H			Part No.	O-Ring Size ²⁾	O-Ring ID x section (mm.)	Retaining Ring Part No.	
G 1/8-28	9.9	15	17.2	1.0	8.5	ED10X1X	5-585	7.98 x 1.88	1/8 RR	D9DT-2
G 1/4-19	13.3	20	20.7	1.5	12.5	ED14X1.5X	2-111	10.77 x 2.62	1/4 RR	D9DT-4
G 3/8-19	16.8	23	24.5	2.0	12.5	EDR3/8X	2-113	13.94 x 2.62	3/8 RR	D9DT-6
G 1/2-14	21.1	28	34.0	2.5	14.5	EDR1/2X	5-256	17.96 x 2.62	1/2 RR	D9DT-8
G 3/4-14	26.6	33	40.0	2.5	16.5	ED26X1.5X	2-119	23.47 x 2.62	3/4 RR	D9DT-12
G 1-11	33.5	41	46.1	2.5	18.5	ED33X2X	2-217	29.74 x 3.53	1 RR	D9DT-16
G 1 1/4-11	42.2	51	54.0	2.5	20.5	ED42X2X	2-222	37.69 x 3.53	1 1/4 RR	D9DT-20
G 1 1/2-11	48.1	56	60.5	2.5	22.5	ED48X2X	2-224	44.04 x 3.53	1 1/2 RR	D9DT-24
G 2-11	59.9	69	73.3	3.0	26.0	—	—	—	—	D9DT-32

Table T26 — Port Detail — ISO 1179-1

- 1) Conforms to proposed revision.
- 2) 90 durometer nitrile is standard for hydraulic applications.
- 3) See page N6 for O-ring and retaining ring ordering information.
- 4) See page N7 for details.

Dimensions and pressures for reference only, subject to change.

ISO 9974-1 – Flat Face Port with Metric Threads

(DIN 3852, Part 1)

Metric ISO261, “M” Thread

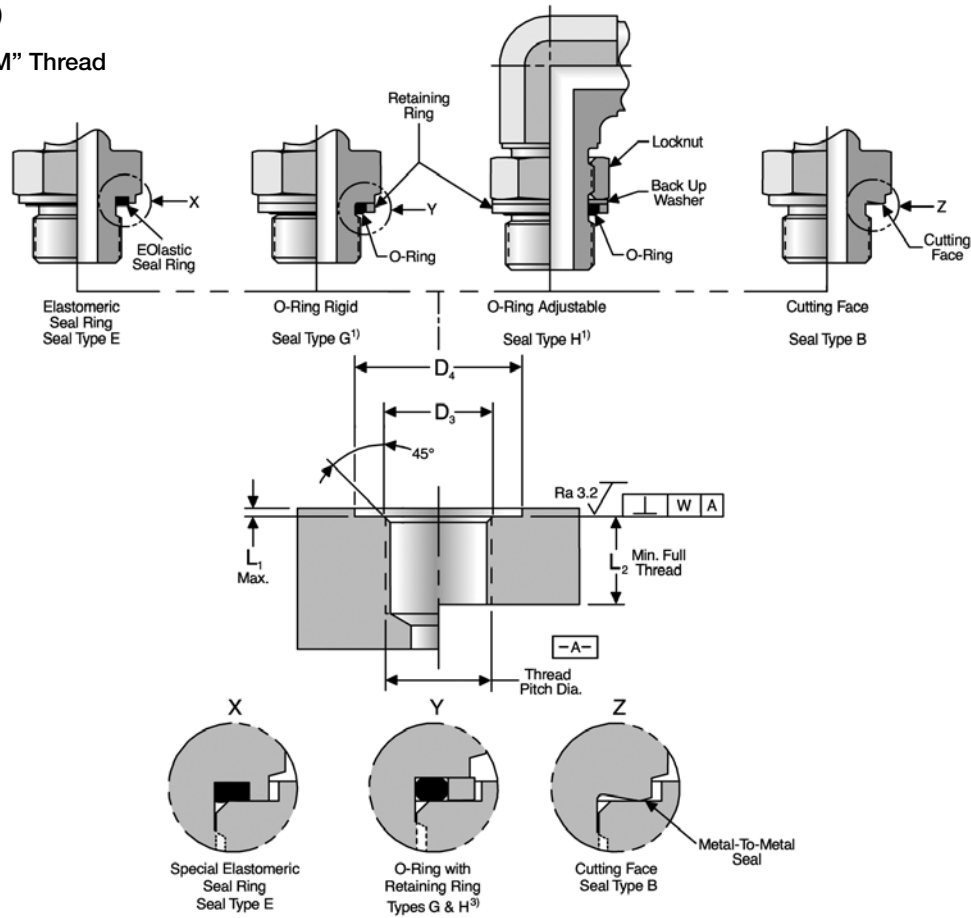

(See Note 1)

ISO 9974 Port seal types available from Parker

Thread Size (ISO 261)	D3 (mm.)	D4 (mm.)	L1 max. (mm.)	L2 min. (mm.)	W (mm.)	EOlastic Seal (Type E)		O-Ring and Retaining Ring¹)	
						Part No.	O-Ring Size²)	O-Ring ID x section (mm.)	Retaining Ring Part No.
M8 x 1	8 +0.2	13	1	8		ED8X1X	3-902	6.07 x 1.63	M8 RR
M10 x 1	10 +0.2	15	1	8		ED10X1X	6-074	8.00 x 1.50	M10 RR
M12 x 1.5	12 +0.2	18	1.5	12		ED12X1.5X	2-012	9.25 x 1.78	M12 RR
M14 x 1.5	14 +0.2	20	1.5	12	0.1	ED14X1.5X	2-013	10.82 x 1.78	M14 RR
M16 x 1.5	16 +0.2	23	1.5	12		ED16X1.5X	3-907	13.46 x 2.08	M16 RR
M18 x 1.5	18 +0.2	25	2	12		ED18X1.5XX	2-114	15.54 x 2.62	M18 RR
M20 x 1.5³)	20 +0.2	27	2	14		ED20X1.5X	2-017	17.17 x 1.78	M20 RR
M22 x 1.5	22 +0.2	28	2.5	14		ED22X1.5X	2-018	18.77 x 1.78	M22 RR
M24 x 1.5⁴)	26 +0.2	30	2.5	14		—	2-019	20.35 x 1.78	M24 RR
M26 x 1.5	26 +0.2	33	2.5	16		ED26X1.5X	2-118	21.89 x 2.62	M26 RR
M27 x 2	27 +0.2	33	2.5	16		ED26X1.5X	2-119	23.47 x 2.62	M27 RR
M33 x 2	33 +0.3	41	2.5	18	0.2	ED33X2X	2-122	28.24 x 2.62	M33 RR
M36 x 2⁴)	36 +0.3	43	2.5	18		—	2-124	31.42 x 2.62	M36 RR
M42 x 2	42 +0.3	51	2.5	20		ED42X2X	2-128	37.77 x 2.62	M42 RR
M45 x 2⁴)	45 +0.3	50	2.5	20		—	2-130	40.94 x 2.62	M45 RR
M48 x 2	48 +0.3	56	2.5	22		ED48X2X	2-132	44.12 x 2.62	M48 RR

Table T27 – Port Detail – ISO 9974-1

- 1) Seal types G and H are not covered in ISO 9974-1. See page N6 for retaining ring and O-Ring ordering information.
- 2) 90 durometer nitrile is standard for hydraulic applications.
- 3) For diagnostic applications.
- 4) These sizes are not covered in ISO 9974-1.

Dimensions and pressures for reference only, subject to change.



NPTF and BSPT Dimensions

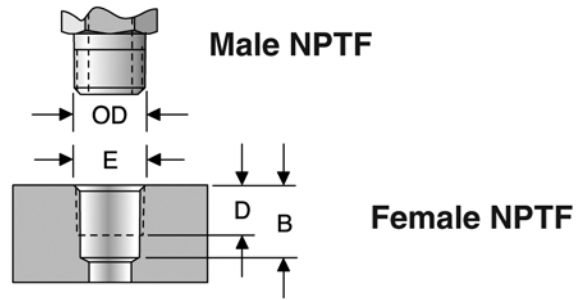

Thread Size NPTF	O.D. Male Thread Large Dia.	D Min.. Thread Length	B Min.. Tap Drill Depth ¹⁾	E Chmf. Dia.
1/8-27	0.41	0.31	0.38	0.42
1/4-18	0.55	0.44	0.47	0.55
3/8-18	0.68	0.47	0.53	0.69
1/2-14	0.85	0.59	0.69	0.85
3/4-14	1.06	0.63	0.75	1.06
1-11 1/2	1.33	0.75	0.84	1.34
1 1/4-11 1/2	1.67	0.78	0.84	1.68
1 1/2-11 1/2	1.91	0.81	0.88	1.92
2-11 1/2	2.39	0.81	0.91	2.39

Table T28 – NPTF Dimensions

1) For bottoming taps only.

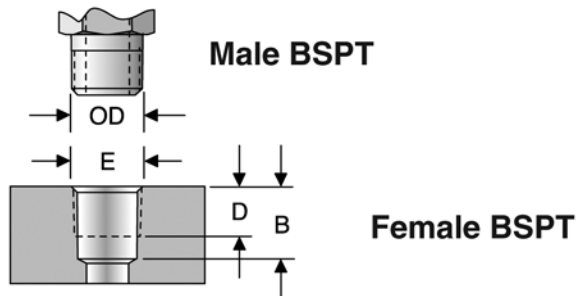

Thread Size BSPT	O.D. Male Thread Large Dia.	D Min.. Thread Length	B Min.. Tap Drill Depth ¹⁾	E Chmf. Dia.
1/8-28	0.39	0.31	0.38	0.42
1/4-19	0.53	0.44	0.47	0.55
3/8-19	0.67	0.47	0.53	0.69
1/2-14	0.84	0.59	0.69	0.85
3/4-14	1.06	0.63	0.75	1.06
1-11	1.33	0.75	0.84	1.34
1 1/4-11	1.67	0.78	0.84	1.68
1 1/2-11	1.90	0.81	0.88	1.92
2-11	2.37	0.81	0.91	2.39

Table T29 – BSPT Dimensions

1) For bottoming taps only.

Dimensions and pressures for reference only, subject to change.

Thread Guide



Dash Size	Tube Size	Triple-Lok SAE 37° Flare	Ferulok SAE Flareless	SAE Straight Thread
2	1/8	5/16-24	5/16-24	5/16-24
3	3/16	3/8-24	3/8-24	3/8-24
4	1/4	7/16-20	7/16-20	7/16-20
5	5/16	1/2-20	1/2-20	1/2-20
6	3/8	9/16-18	9/16-18	9/16-18
8	1/2	3/4-16	3/4-16	3/4-16
10	5/8	7/8-14	7/8-14	7/8-14
12	3/4	1 1/16-12	1 1/16-12	1 1/16-12
16	1	1 5/16-12	1 5/16-12	1 5/16-12
20	1 1/4	1 5/8-12	1 5/8-12	1 5/8-12
24	1 1/2	1 7/8-12	1 7/8-12	1 7/8-12
32	2	2 1/8-12	2 1/8-12	2 1/8-12



Dash Size	Tube Size	Seal-Lok O-Ring Face Seal	SAE 45° Flare	N.P.T.
2	1/8	—	5/16-24	1/8-27
3	3/16	—	3/8-24	—
4	1/4	9/16-18	9/16-18	1/4-18
5	5/16	—	1/2-20	—
6	3/8	11/16-16	5/8-18	3/8-18
8	1/2	13/16-16	3/4-16	1/2-14
10	5/8	1-14	7/8-14	—
12	3/4	1 3/16-12	1 1/16-14	3/4-14
16	1	1 7/16-12	1 3/8-12	1-11 1/2
20	1 1/4	1 11/8-12	—	1 1/4-11 1/2
24	1 1/2	2-12	—	1 1/2-11 1/2
32	2	—	—	2-11 1/2

Dimensions and pressures for reference only, subject to change.

