

R55FPWQ

Photoelectric Sensor – Photoelectric Sensor for Plastic Fibers

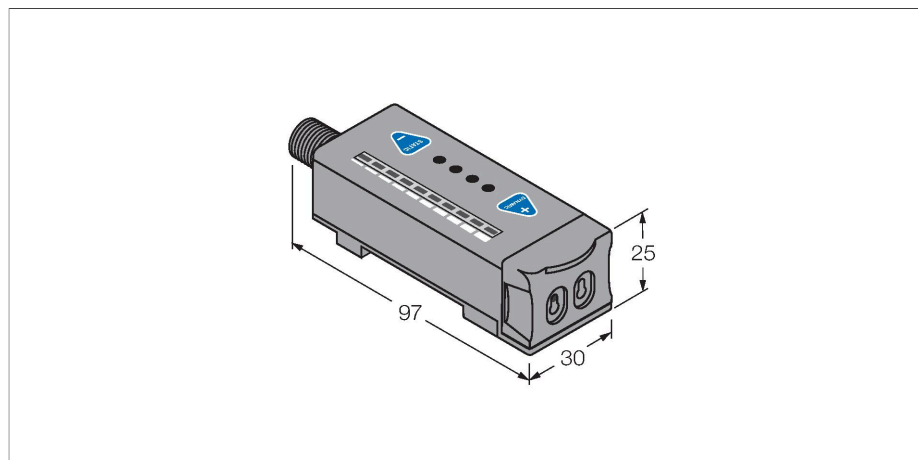

Features

- Male M12 × 1, 5-pin
- Protection class IP67
- Teach button
- 10-segment bargraph
- Switch-off delay (no delay, 20 ms, 40 ms)
- White emitter LED
- Operating voltage: 10...30 VDC
- Switching output, bipolar
- Light or dark operation

Wiring diagram

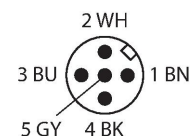
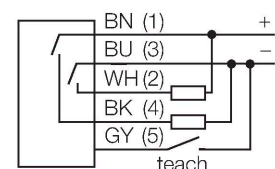

Technical data

Type	R55FPWQ
ID	3058029
Optical data	
Function	Fiber optic sensor
Operating mode	Plastic fiber
Fiber-optic type	plastic
Light type	White
Electrical data	
Operating voltage	10...30 VDC
Residual ripple	< 10 % U _{ss}
No-load current	≤ 70 mA
Short-circuit protection	yes
Reverse polarity protection	yes
Output function	NO contact, PNP/NPN
Switching frequency	10 kHz
Readiness delay	≤ 100 ms
Response time typical	< 0.05 ms
Setting option	Push Button Remote Teach
Mechanical data	
Design	Rectangular, R55F
Dimensions	97 x 30 x 25 mm
Housing material	Plastic, Thermoplastic material, Black
Electrical connection	Connector, M12 × 1, PVC
Number of cores	5
Ambient temperature	-10...+55 °C
Relative humidity	0...90 %

Functional principle

Glass or fibre optic sensors are the optimum choice for high temperature or space restricted applications. Fibre optics transfer the light from the sensor to a remote object. Individual fibre optics are used for opposed mode sensing, whereas bifurcated fibre optics are suited for diffuse mode operation.

Technical data

Protection class	IP67
Special features	keep/defer Wash down
Power-on indication	LED, Green
Switching state	LED, Green
Excess gain indication	Bargraph, green
Tests/approvals	
MTTF	178 years acc. to SN 29500 (Ed. 99) 40 °C
Approvals	CE

Accessories

SMBR55F01	3067104	SMBR55FRA	3058809
	Mounting panel, PBT, black, for R55F series, wall mounting		Mounting bracket, 19-ga. stainless steel, for D10, DF-G1 and R55F series, lateral wall mounting
DIN-35-70	3026604	DIN-35-105	3030470
	DIN rail, width 35 mm, length 70 mm		DIN rail, width 35 mm, length 105 mm
DIN-35-140	3026605		
	DIN rail, width 35 mm, length 140 mm		

Accessories

Dimension drawing	Type	ID	
	WKC4.5T-2/TEL	6625028	Connection cable, female M12, angled, 5-pin, cable length: 2 m, sheath material: PVC, black; cULus approval; other cable lengths and qualities available, see www.turck.com
	RKC4.5T-2/TEL	6625016	Connection cable, female M12, straight, 5-pin, cable length: 2 m, sheath material: PVC, black; cULus approval; other cable lengths and qualities available, see www.turck.com

Accessories

Dimension drawing	Type	ID	
	PBT16U	3042822	Plastic fiber-optic sensor, operating mode: Diffuse mode, threaded sleeve M3 x 0.75 mm, field wireable wire without end tip, polyethylene sheath, ambient temperatures -30 °C...+70 °C

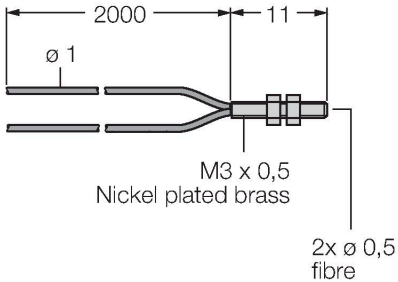
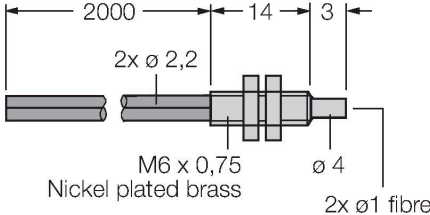
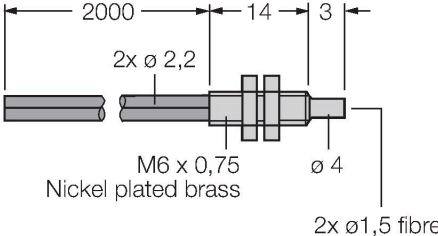
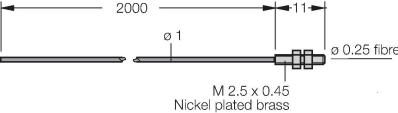
Dimension drawing	Type	ID	
 <p>Dimension drawing of PBT26U sensor. It shows a long cable with a diameter of $\varnothing 1$ mm. The total length is 2000 mm. The sensing tip is 11 mm long and features a threaded bush with an M3 x 0,5 thread. The tip is made of nickel-plated brass and contains two $\varnothing 0,5$ mm fibers.</p>	PBT26U	3026080	Plastic fiber, sensing mode: Diffuse mode, threaded bush M3 x 0.75 mm, preassembled wire without end tip, polyethylene jacket, ambient temperatures -30 °C...+70 °C
 <p>Dimension drawing of PBT46U sensor. It shows a long cable with a diameter of $\varnothing 2,2$ mm. The total length is 2000 mm. The sensing tip is 14 mm long and features a threaded sleeve with an M6 x 0,75 thread. The tip is made of nickel-plated brass and contains two $\varnothing 1$ mm fibers. The diameter of the tip section is $\varnothing 4$ mm.</p>	PBT46U	3025967	Plastic fiber-optic sensor, operating mode: Diffuse mode, threaded sleeve M3 x 0.75 mm, field wireable wire without end tip, polyethylene sheath, ambient temperatures -30 °C...+70 °C
 <p>Dimension drawing of PBT66U sensor. It shows a long cable with a diameter of $\varnothing 2,2$ mm. The total length is 2000 mm. The sensing tip is 14 mm long and features a threaded sleeve with an M6 x 0,75 thread. The tip is made of nickel-plated brass and contains two $\varnothing 1,5$ mm fibers. The diameter of the tip section is $\varnothing 4$ mm.</p>	PBT66U	3039982	Plastic fiber-optic sensor, operating mode: Diffuse mode, threaded sleeve M6 x 0.75 mm, pre-assembled wire without end tip, polyethylene sheath, ambient temperatures -30 °C...+70 °C
 <p>Dimension drawing of PIT16U sensor. It shows a long cable with a diameter of $\varnothing 1$ mm. The total length is 2000 mm. The sensing tip is 11 mm long and features a threaded sleeve with an M 2.5 x 0.45 thread. The tip is made of nickel-plated brass and contains one $\varnothing 0,25$ mm fiber.</p>	PIT16U	3039983	Plastic fiber-optic sensor, operating mode: Opposed mode, threaded sleeve M3 x 0.5 mm, field wireable wire without end tip, polyethylene sheath, ambient temperatures -30 °C...+70 °C

Dimension drawing	Type	ID	
	PIT26U	3026079	Plastic fiber, sensing mode: Opposed mode, threaded bush M3 x 0.5 mm, preassembled wire without end tip, polyethylene jacket, ambient temperatures -30 °C...+70 °C

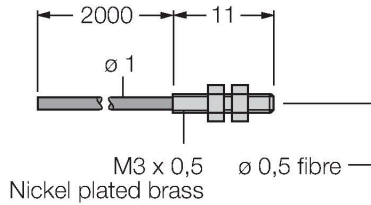

	PIT46U	3026034	Plastic fiber-optic sensor, operating mode: Opposed mode, threaded sleeve M3 x 0.5 mm, field wireable wire without end tip, polyethylene sheath, ambient temperatures -30 °C...+70 °C
--	--------	---------	---

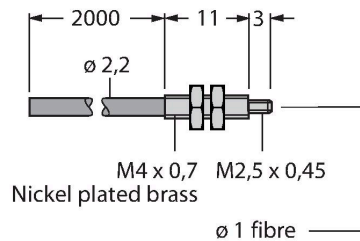

	PIT66U	3039899	Plastic fiber-optic sensor, operating mode: Opposed mode, threaded sleeve M3 x 0.5 mm, field wireable wire without end tip, polyethylene sheath, ambient temperatures -30 °C...+70 °C
--	--------	---------	---

