

DS

## Basic Pump

## Self Priming Centrifugal Pump



Model T10A3S-B

Size 10" x 10"



## PUMP SPECIFICATIONS

**Size:** 10" x 10" (254 mm x 254 mm) Flanged.**Casing:** Gray Iron 30.

Maximum Operating Pressure 99 psi (683 kPa).\*

**Semi-Open Type, Two Vane Impeller:** Ductile Iron 65-45-12.

Handles 3" (76,2 mm) Diameter Spherical Solids.

**Impeller Shaft:** Stainless Steel 17-4 PH.**Shaft Sleeve:** Alloy Steel 4130.**Replaceable Front Wear Plate:** Ductile Iron 80-55-06.**Replaceable Rear Wear Plate:** Carbon Steel 1026.**Removable Clean-out Cover Plate:** Gray Iron 30; 9 lbs. (4 kg).**Flap Valve:** Neoprene w/Steel Reinforcing.**Seal Plate:** Gray Iron 30.**Bearing Housing:** Gray Iron 30.**Radial and Thrust Bearings:** Open Double Row Ball.**Bearing and Seal Cavity Lubrication:** SAE 30 Non-Detergent Oil.**Suction Flange:** Gray Iron 30.**Suction Head:** Gray Iron 30.**Gaskets:** Buna-N, PTFE, Cork, and Rubber.**O-Rings:** Buna-N.**Hardware:** Standard Plated Steel.**Brass Pressure Relief Valve.****Bearing and Seal Cavity Oil Level Sight Gauges.****Optional Equipment:** Metal Bellows Seal. Automatic Air

Release Valve. High Pump Temperature Shutdown Kit.

120V/240V Casing Heater. Continuous Vane Ductile Iron

Impeller w/Self-Cleaning Ductile Iron Wear Plate.

Gray Iron 30 Spool Flanges:

10" ASA Discharge.

250 mm DIN 2527 (PN 16) Suction and Discharge

**(Specify Model T10A3S-B /FM).***\*Consult Factory for Applications Exceeding Maximum Pressure and/or Temperature Indicated.*

Shown with Optional Discharge Spool Flange (Suction/Discharge Spool Flanges Available in ASA or DIN Standard Sizes).

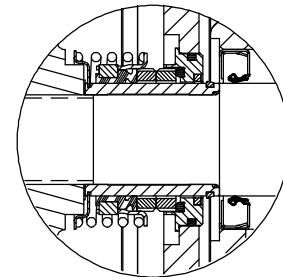
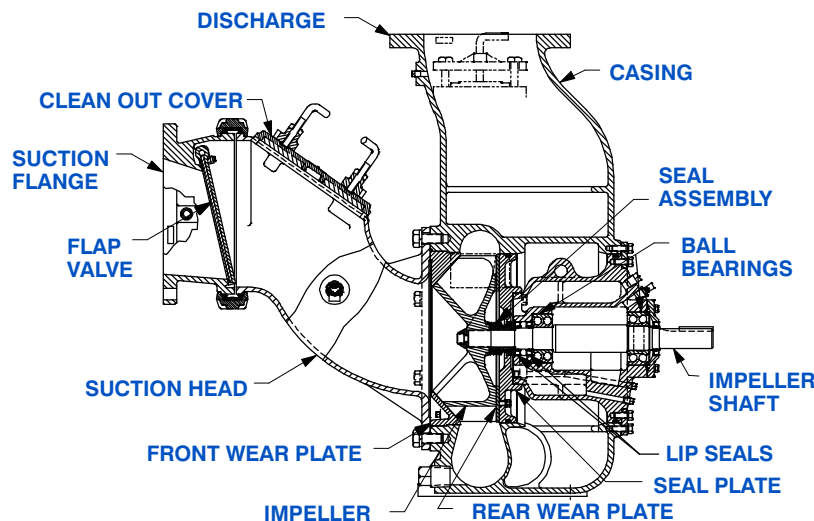

## SEAL DETAIL

Cartridge Type, Mechanical, Oil-Lubricated, Double Floating, Self-Aligning. Tungsten Titanium Carbide Rotating and Stationary Faces. Stainless Steel 316 Stationary Seat. Fluorocarbon Elastomers (DuPont Viton® or Equivalent). Stainless Steel 18-8 Cage and Spring. Maximum Temperature of Liquid Pumped, 160°F (71°C).\*



THE GORMAN-RUPP COMPANY • MANSFIELD, OHIO

GORMAN-RUPP OF CANADA LIMITED • ST. THOMAS, ONTARIO, CANADA

www.grpumps.com

Specifications Subject to Change Without Notice

Printed in U.S.A.

# Specification Data

**NET WEIGHT:** 1440 LBS. (653 KG.)\*  
**SHIPPING WEIGHT:** 1590 LBS. (721 KG.)\*  
**EXPORT CRATE:** 70.3 CU. FT. (2 CU. M.)  
**\*ADD 71 LBS. (32,2 KG.) W/DISCH SPOOL FLANGE**

SECTION 55, PAGE 2400

## APPROXIMATE DIMENSIONS and WEIGHTS

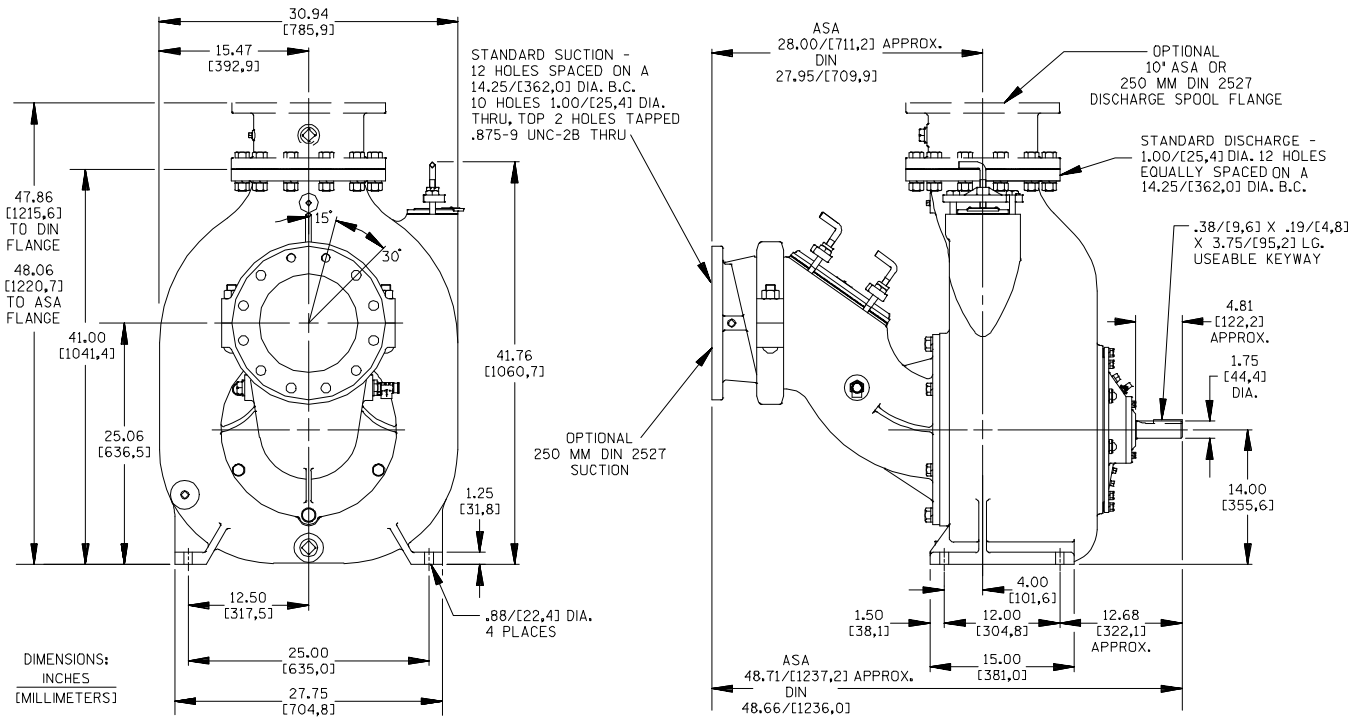

OPTIONAL ASA OR DIN STANDARD SPOOL FLANGES AVAILABLE

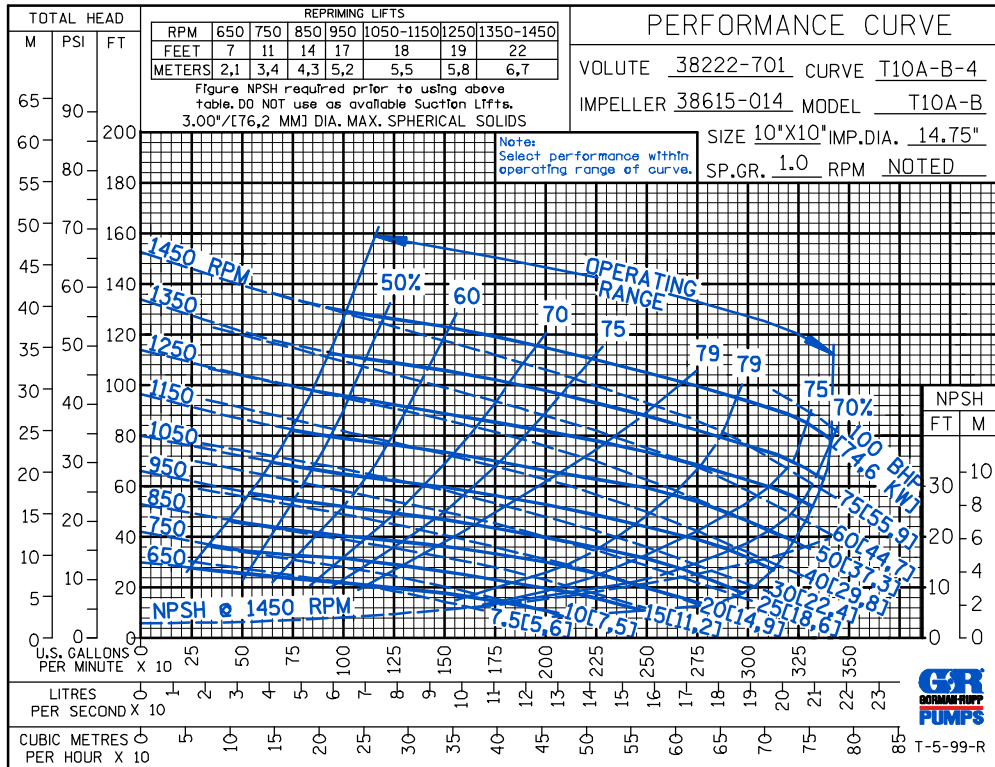

THE GORMAN-RUPP COMPANY • MANSFIELD, OHIO

GORMAN-RUPP OF CANADA LIMITED • ST. THOMAS, ONTARIO, CANADA

Specifications Subject to Change Without Notice

Printed in U.S.A.

CDS

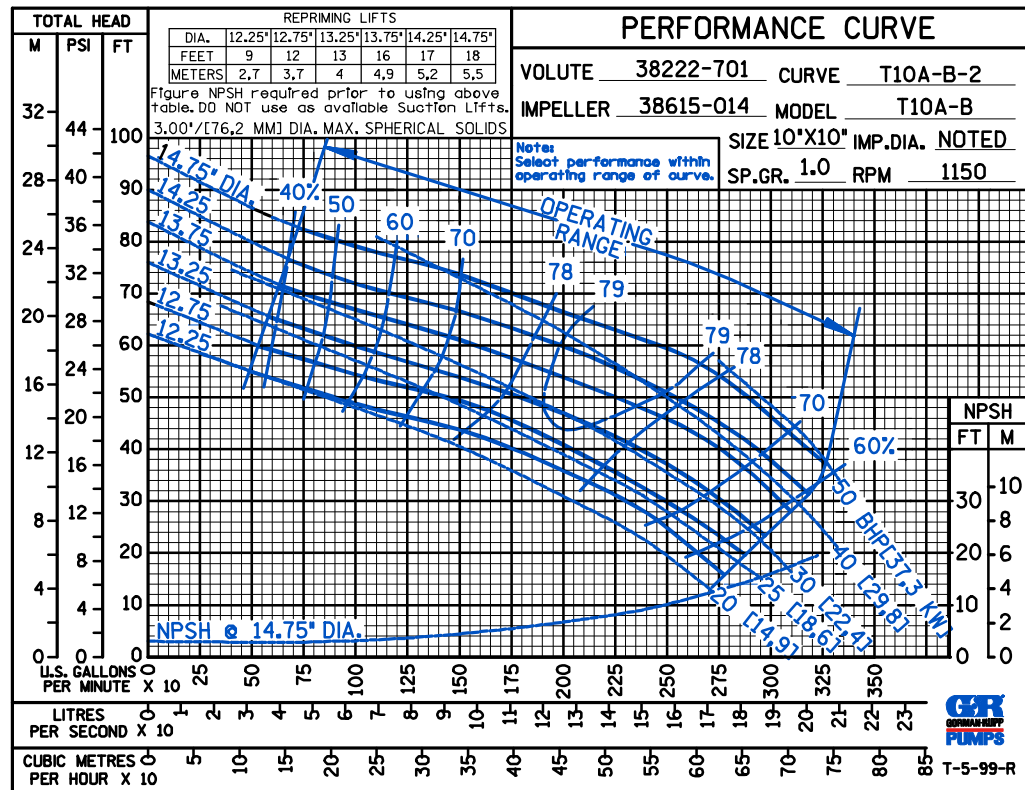
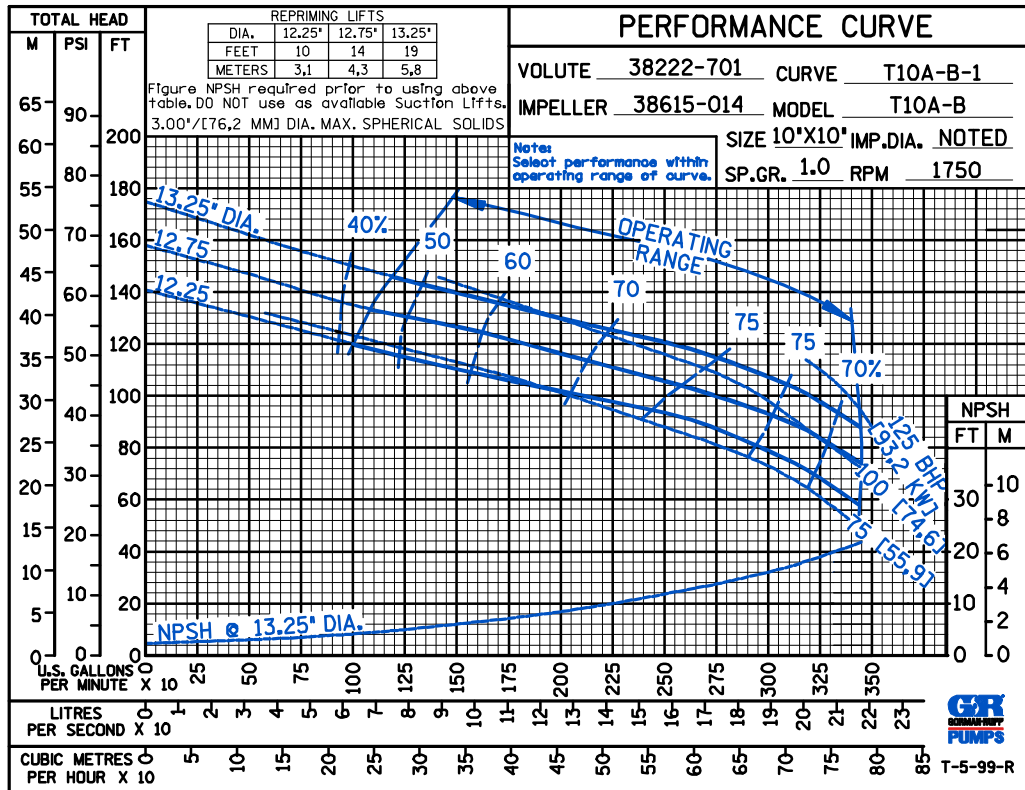

THE GORMAN-RUPP COMPANY • MANSFIELD, OHIO

GORMAN-RUPP OF CANADA LIMITED • ST. THOMAS, ONTARIO, CANADA

Specifications Subject to Change Without Notice

Printed in U.S.A.

CDS

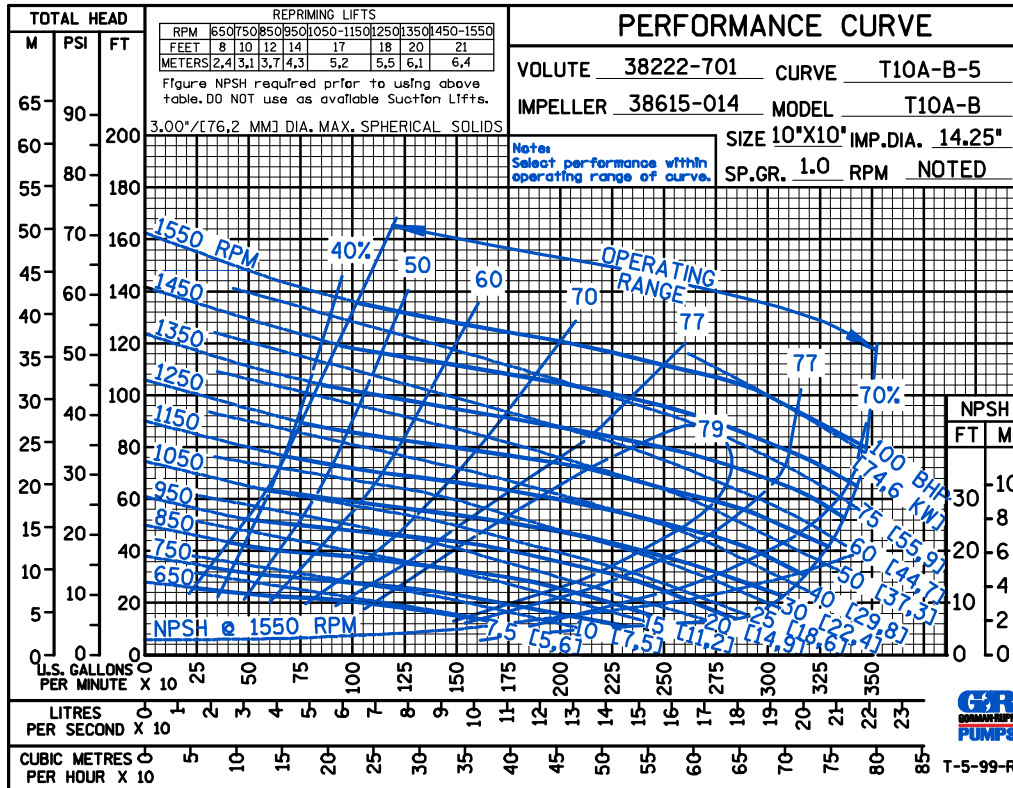
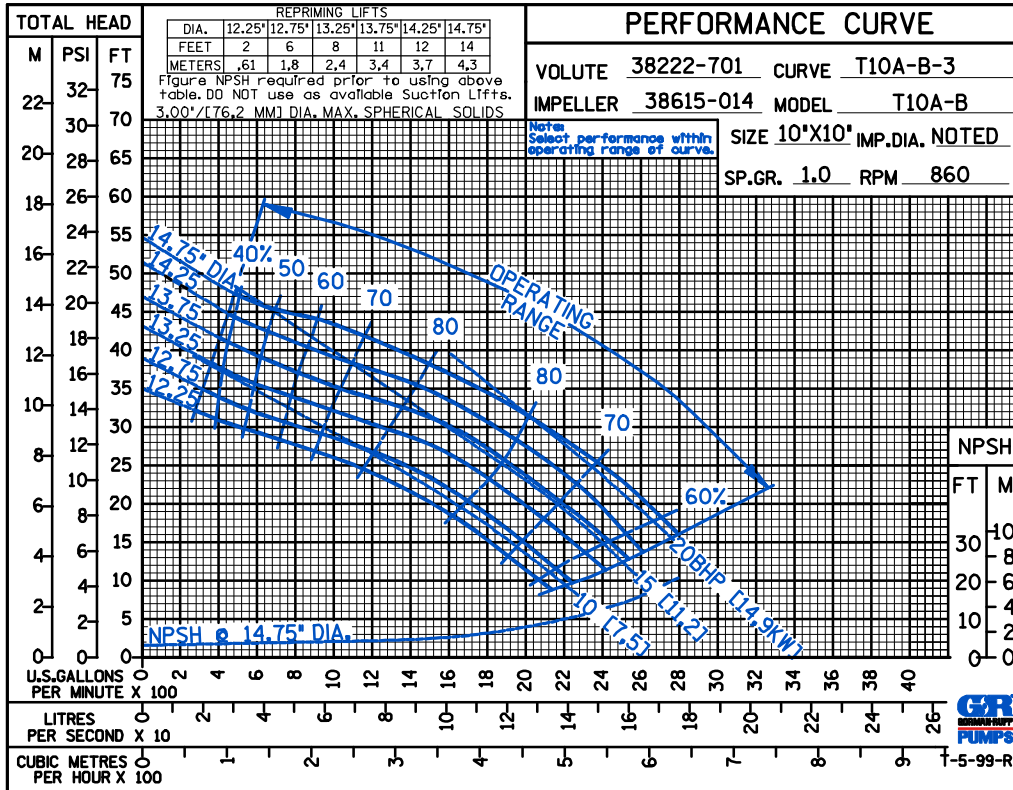

THE GORMAN-RUPP COMPANY • MANSFIELD, OHIO

GORMAN-RUPP OF CANADA LIMITED • ST. THOMAS, ONTARIO, CANADA

Specifications Subject to Change Without Notice

Printed in U.S.A.

CDS

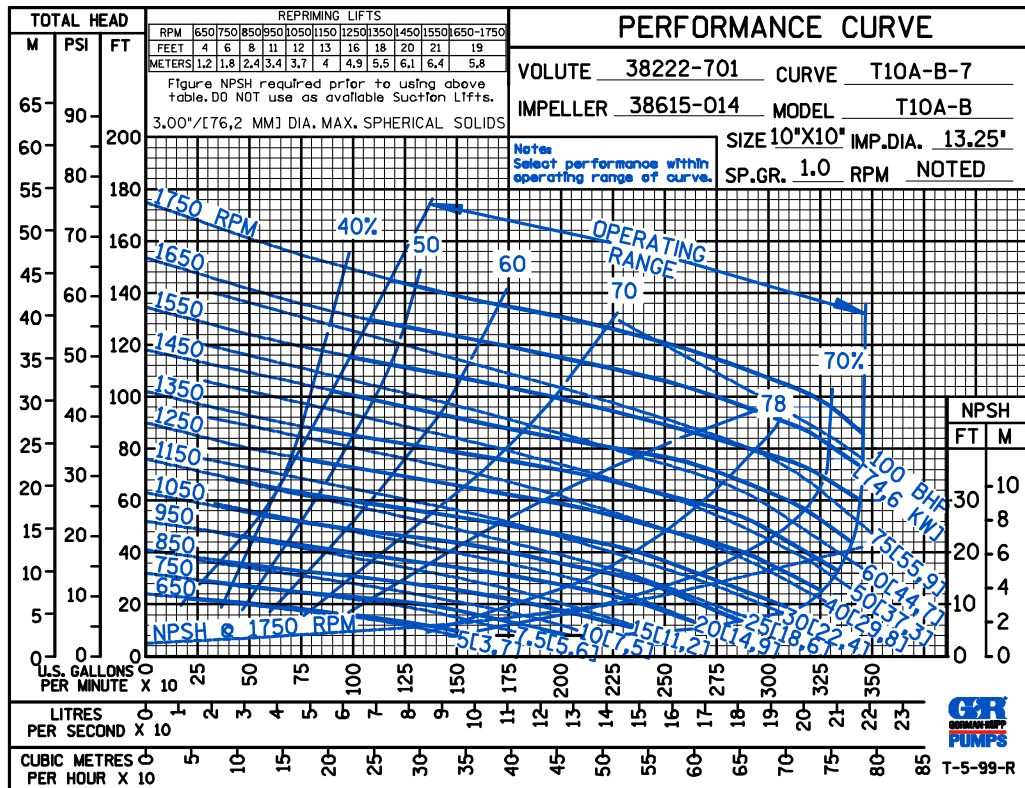
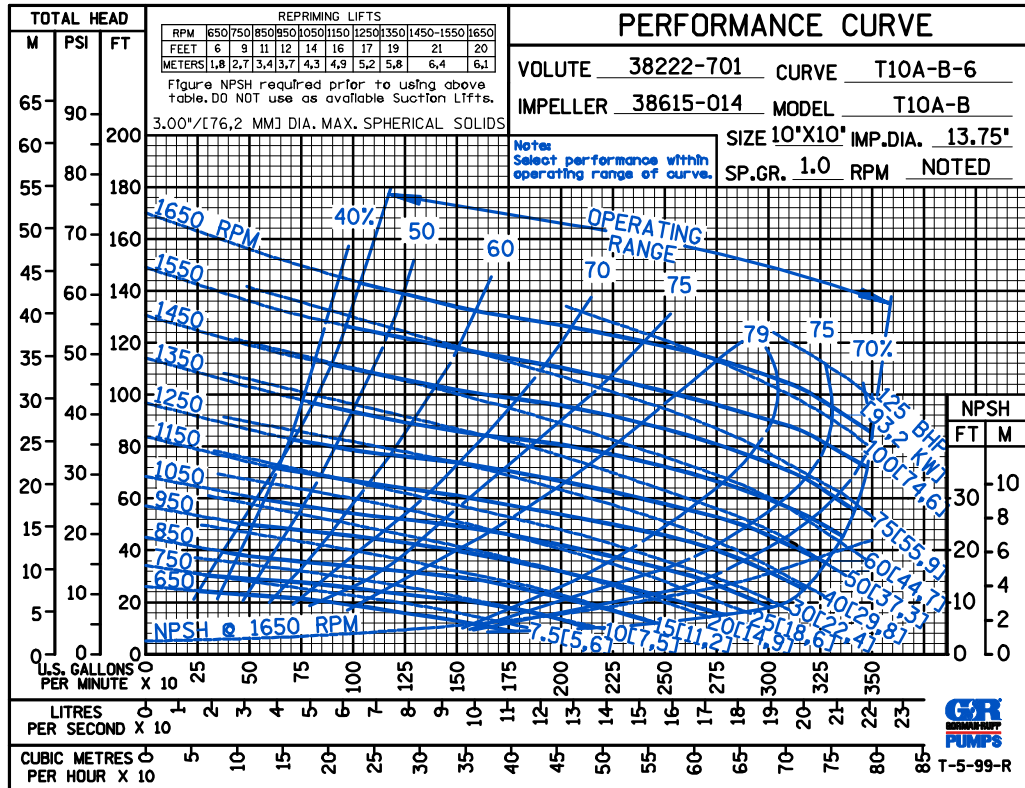

THE GORMAN-RUPP COMPANY • MANSFIELD, OHIO

GORMAN-RUPP OF CANADA LIMITED • ST. THOMAS, ONTARIO, CANADA

Specifications Subject to Change Without Notice

Printed in U.S.A.

CDS

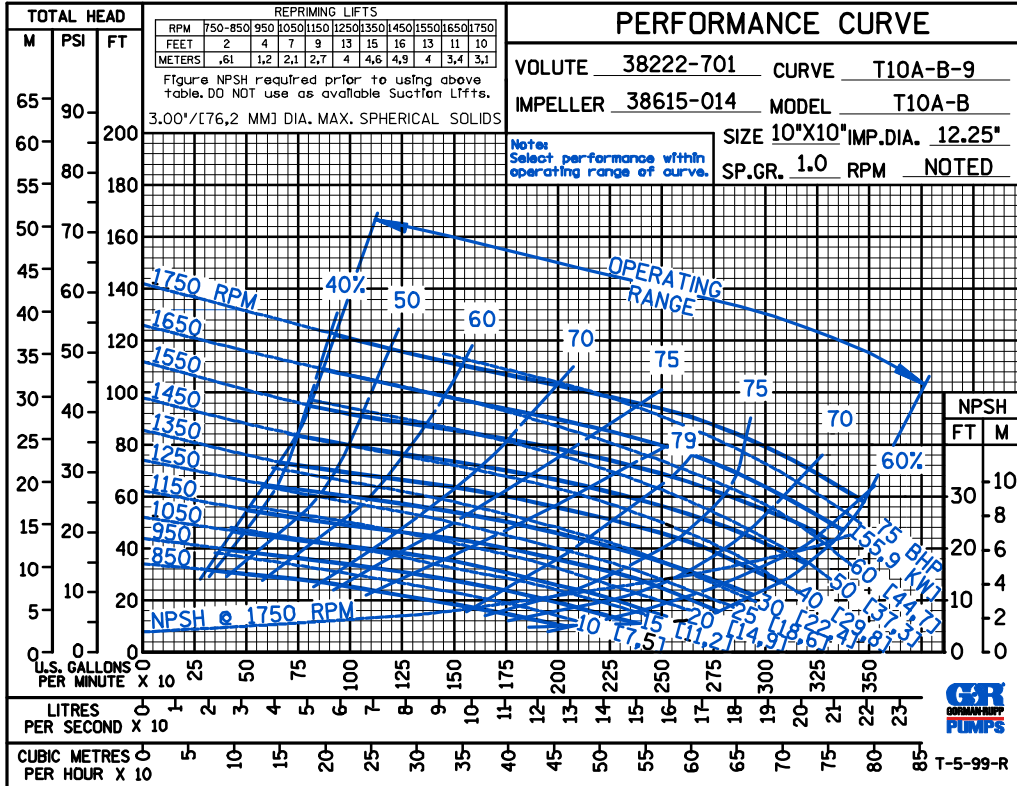
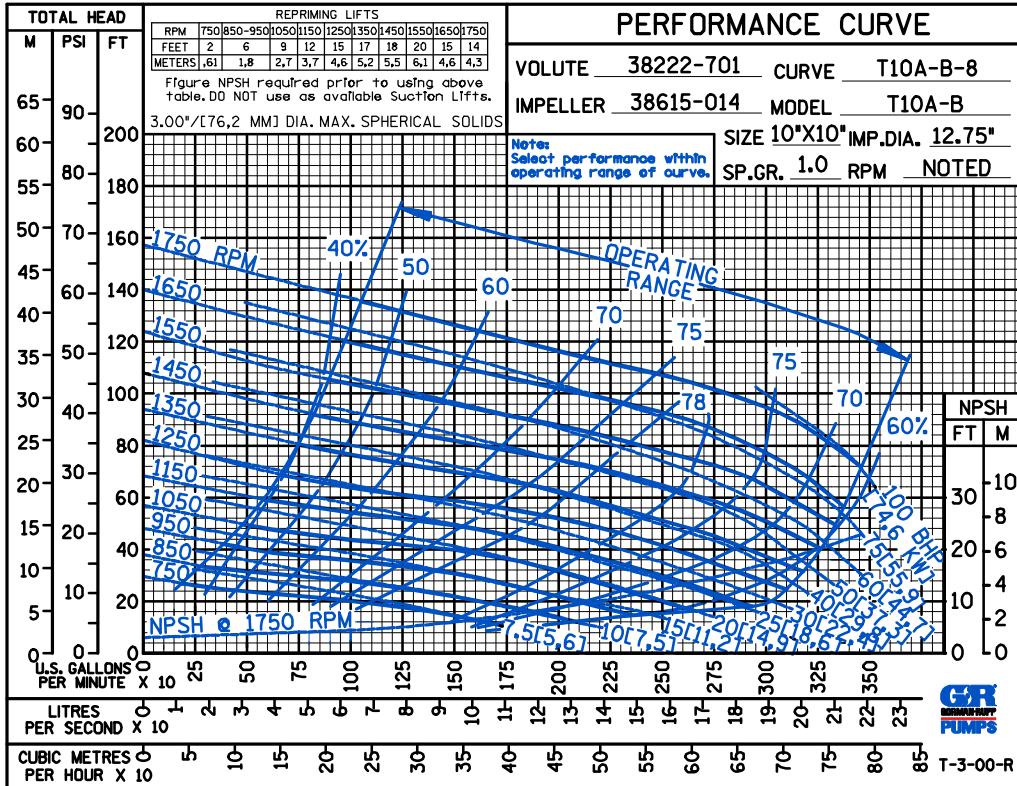

THE GORMAN-RUPP COMPANY • MANSFIELD, OHIO

GORMAN-RUPP OF CANADA LIMITED • ST. THOMAS, ONTARIO, CANADA

Specifications Subject to Change Without Notice

Printed in U.S.A.

CDS

50 HERTZ

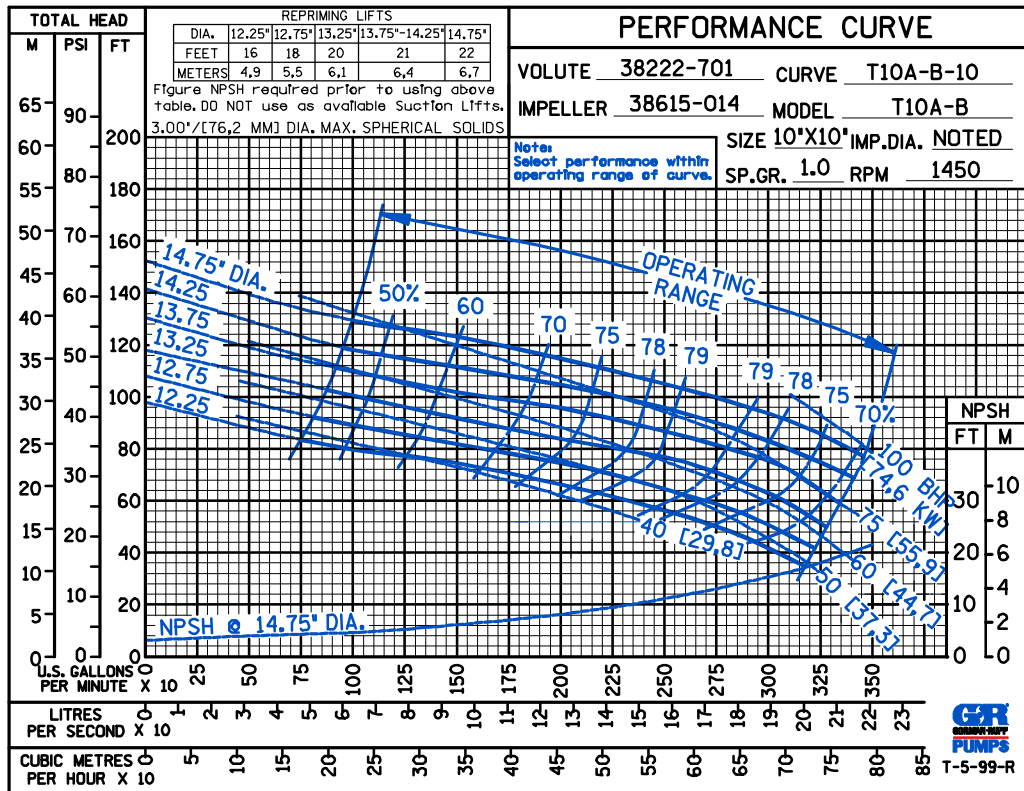

50 HERTZ

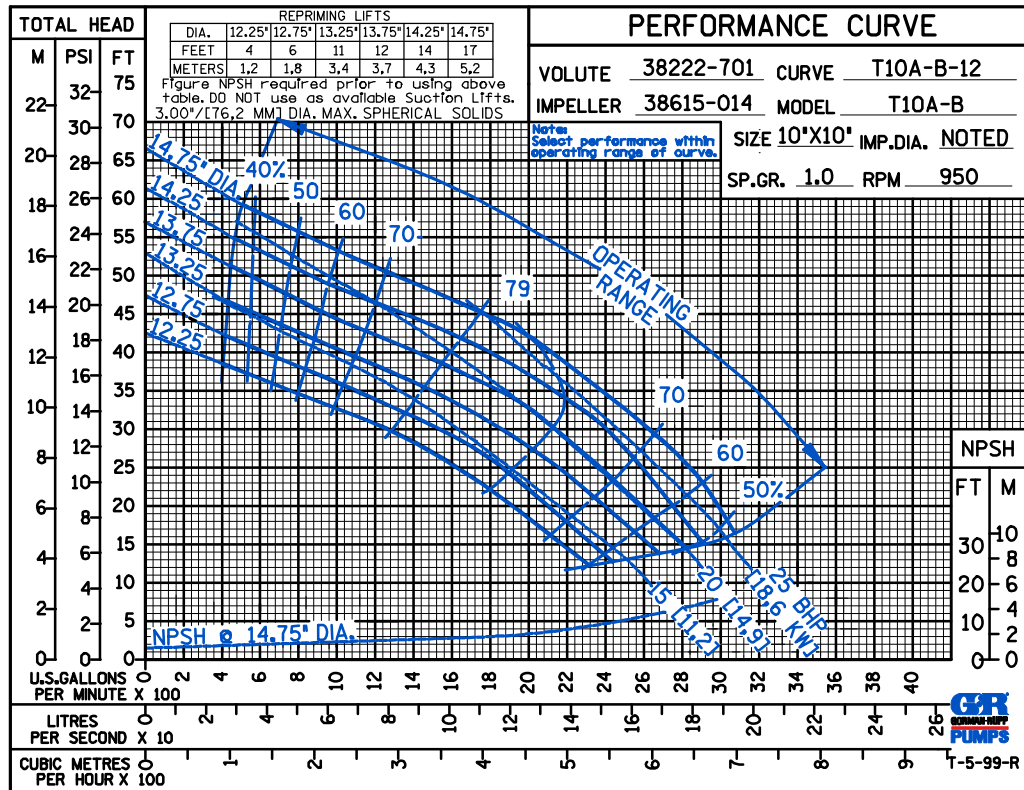

THE GORMAN-RUPP COMPANY • MANSFIELD, OHIO

GORMAN-RUPP OF CANADA LIMITED • ST. THOMAS, ONTARIO, CANADA

Specifications Subject to Change Without Notice

Printed in U.S.A.

D S

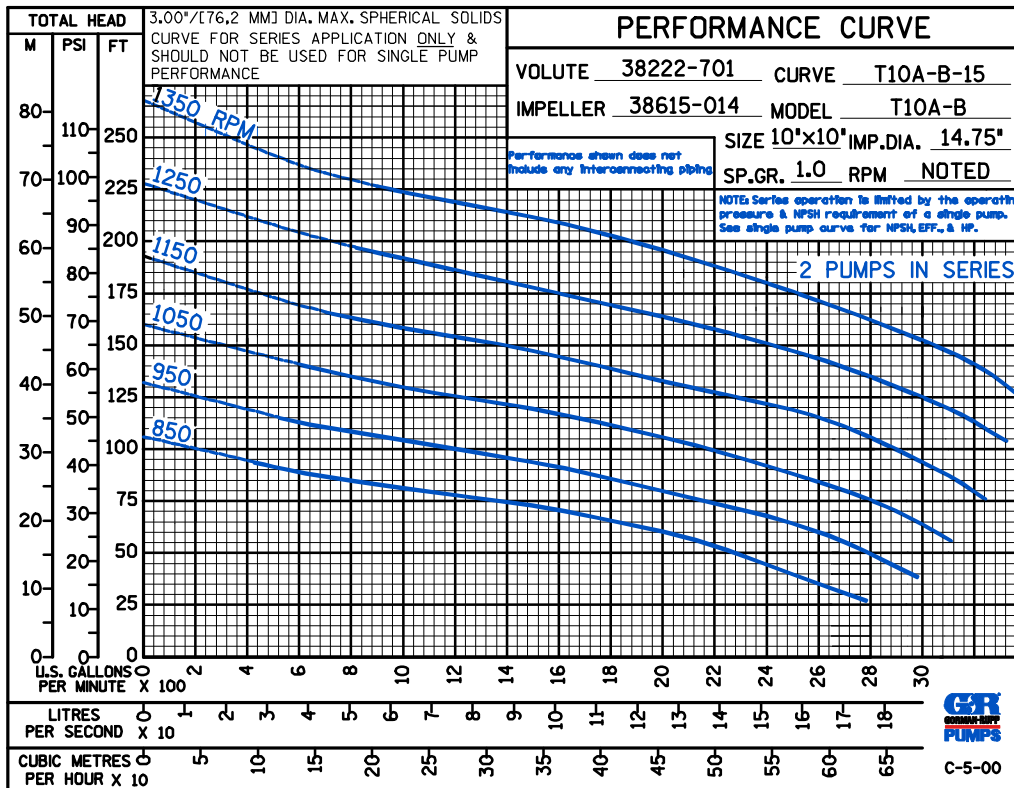
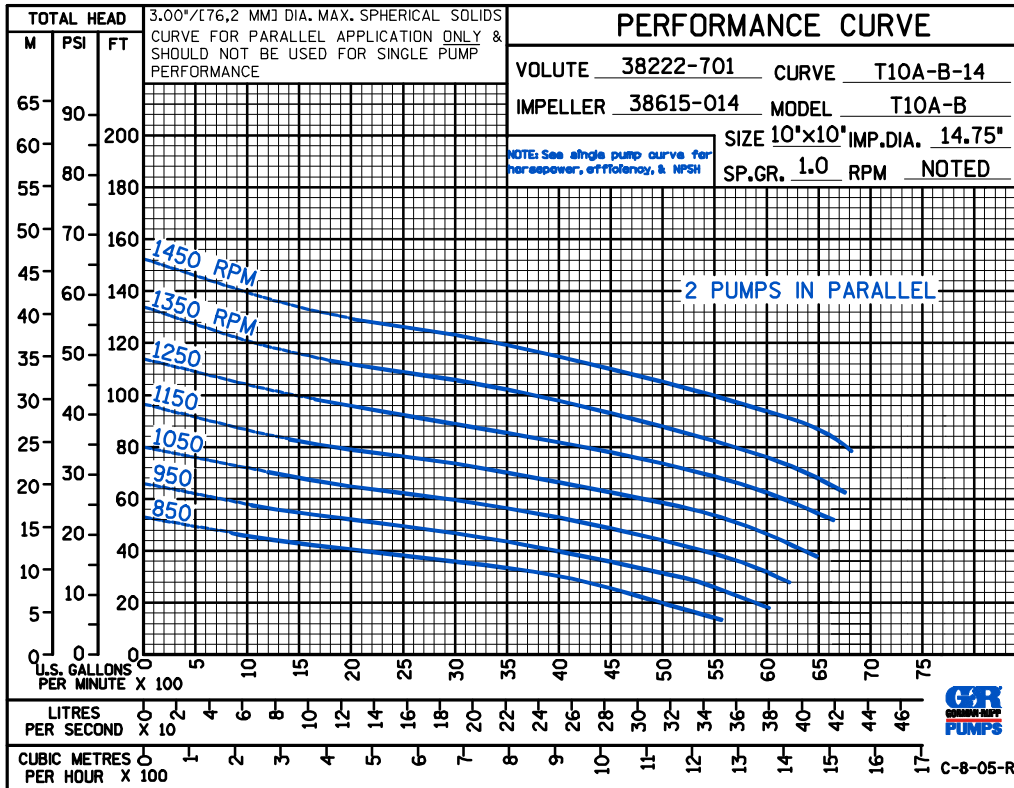

THE GORMAN-RUPP COMPANY • MANSFIELD, OHIO

GORMAN-RUPP OF CANADA LIMITED • ST. THOMAS, ONTARIO, CANADA

Specifications Subject to Change Without Notice

Printed in U.S.A.



CDS

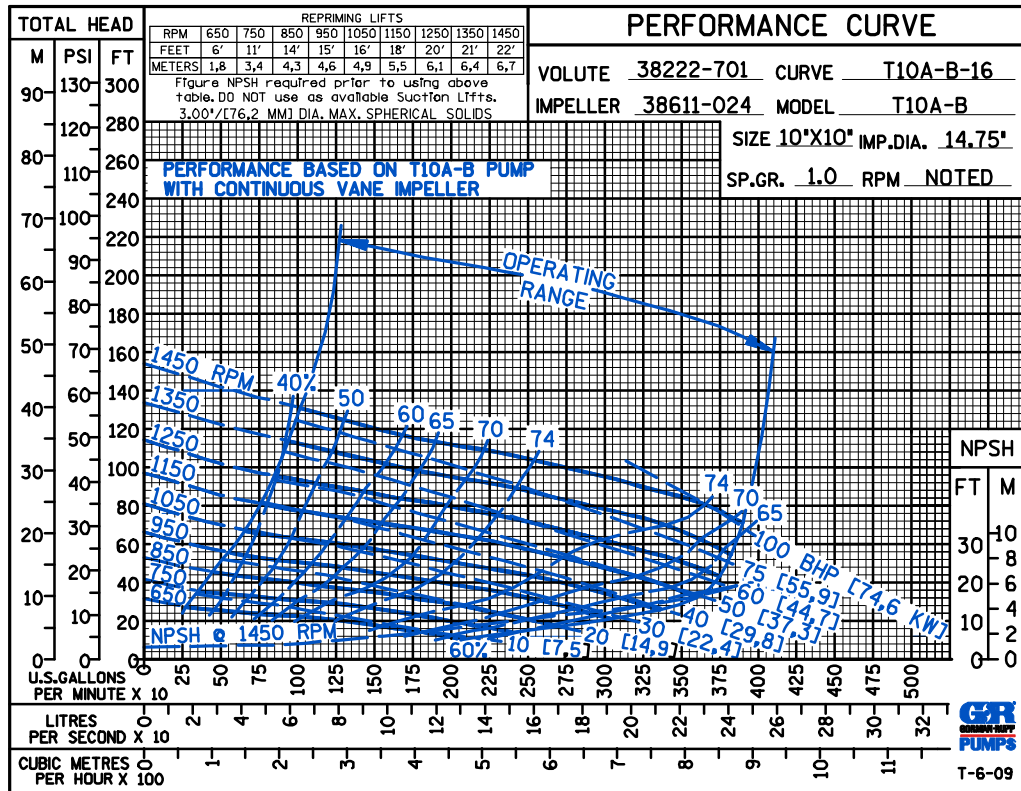

THE GORMAN-RUPP COMPANY • MANSFIELD, OHIO

GORMAN-RUPP OF CANADA LIMITED • ST. THOMAS, ONTARIO, CANADA

Specifications Subject to Change Without Notice

Printed in U.S.A.