

# Online Data Sheet

## Encoder WDGI 58C

[www.wachendorff-automation.com/wdgi58c](http://www.wachendorff-automation.com/wdgi58c)

### **Wachendorff Automation**

#### **... systems and encoders**

- Complete systems
- Industrial rugged encoders to suit your application
- Standard range and customer versions
- Maximum permissible loads
- 48-hour express production
- Made in Germany
- Worldwide distributor network

# Encoder WDGI 58C



- Rugged industrial standard encoder
- Housing cap die cast aluminum, with particularly eco-friendly powder coating
- Up to 25000 PPR by use of high grad electronics
- Protection to IP67, shaft sealed to IP65
- High noise immunity
- Full connection protection with 10 VDC up to 30 VDC
- High output frequency 600 kHz/2 MHz
- Optional: -40 °C up to +85 °C, Pressure equalising membrane

[www.wachendorff-automation.com/wdgi58c](http://www.wachendorff-automation.com/wdgi58c)

## Resolution

Max. pulses per revolution up to 25000 PPR  
PPR

## Mechanical Data

### Housing

Flange	synchro flange
Flange material	aluminum
Housing cap	die cast aluminum, powder coated
Housing	Ø 58 mm
Cam mounting	pitch 69 mm

### Shaft(s)

Shaft material	stainless steel
Starting torque	approx. 1 Ncm at ambient temperature

Shaft	Ø 10 mm
Shaft length	L: 20 mm
Max. Permissible shaft loading radial	200 N
Max. Permissible shaft loading axial	120 N

### Bearings

Bearings type	2 precision ball bearings
Nominale service life	1 x 10 <sup>9</sup> revs. at 100 % rated shaft load 1 x 10 <sup>10</sup> revs. at 40 % rated shaft load 1 x 10 <sup>11</sup> revs. at 20 % rated shaft load
Max. operating speed	8000 rpm

## Machinery Directive: basic data safety integrity level

MTTF <sub>d</sub>	200 a
Mission time (TM)	25 a
Nominale service life (L10h)	1 x 10 <sup>11</sup> revs. at 20 % rated shaft load and 8000 rpm
Diagnostic coverage (DC)	0 %

## Electrical Data

Power supply/Current consumption	4,75 VDC up to 5,5 VDC: typ. 100 mA
Power supply/Current consumption	5 VDC up to 30 VDC: typ. 70 mA
Power supply/Current consumption	10 VDC up to 30 VDC: typ. 100 mA
Output circuit	TTL TTL, RS422 compatible, inv. HTL HTL, inv. 1 Vpp sin/cos

Pulse frequency	TTL 5000 ppr: max. 200 kHz HTL 5000 ppr: max. 200 kHz TTL more than 1200 ppr: max. 2 MHz HTL more than 1200 ppr: max. 600 kHz 1 Vpp sin/cos: max. 100 kHz
Channels	AB ABN and inverted signals
Load	max. 40 mA / channel @ 1 Vpp sin/cos: min. 120 Ohm
Circuit protection	circuit type F24, G24, H24, I24, P24, R24 only

## Accuracy

Phase offset	90° ± max. 7.5 % of the pulse length
pulse-/pause-ratio	5000 ppr: 50 % ± max. 7 % >5000 ppr: 50 % ± max. 10 %

## General Data

Weight	approx. 230 g
Connections	cable or connector outlet
Protection rating (EN 60529)	IP67, shaft sealed to IP65
Operating temperature	Connector: -20 °C up to +85 °C, cable: -20 °C up to +80 °C, (Option ACA: -40 °C up to +85 °C) 1 Vpp: -10 °C up to +70 °C
Storage temperature	Connector: -30 °C up to +85 °C, cable: -30 °C up to +80 °C, option ACA: -40 °C up to +85 °C

## More Information

General technical data and safety instructions  
<http://www.wachendorff-automation.com/gtd>  
Options  
<http://www.wachendorff-automation.com/acc>

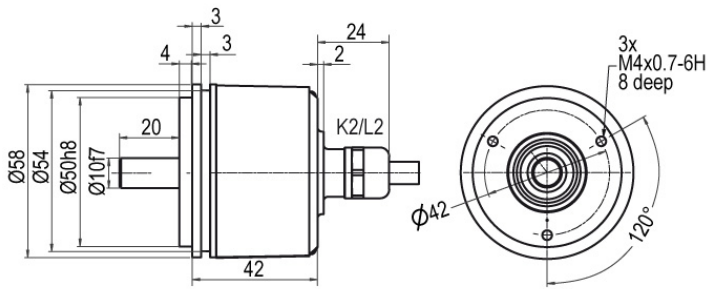
**WDGI 58C: Cable connection K2, L2, axial, with 2 m cable**

**Description**
**ABN inv. poss.**

<b>K2</b>	axial, shield not connected	•
<b>L2</b>	axial, shield connected to encoder housing	•

Assignments					
	K2, L2	K2, L2	K2, L2	K2, L2	K2, L2
<b>Circuit</b>	G05, G24	F05, H05, F24, H24, H30	I05, I24, 524	P05, R05, P24, R24, 245, 645, R30	SIN
<b>GND</b>	WH	WH	WH	WH	WH
<b>(+) Vcc</b>	BN	BN	BN	BN	BN
<b>A</b>	GN	GN	GN	GN	GN
<b>B</b>	YE	YE	YE	YE	GY
<b>N</b>	GY	GY	GY	GY	-
<b>Light reserve warning</b>	PK	-	PK	-	-
<b>A inv.</b>	-	-	RD	RD	YE
<b>B inv.</b>	-	-	BK, (BU at ACA)	BK, (BU at ACA)	PK
<b>N inv.</b>	-	-	VT	VT	-
<b>Shield</b>	flex	flex	flex	flex	flex

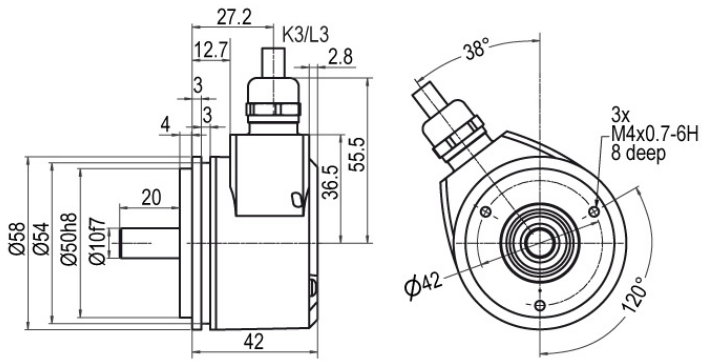
**WDGI 58C: Cable connection K3, L3, radial, with 2 m cable**



**Description**

**ABN inv. poss.**





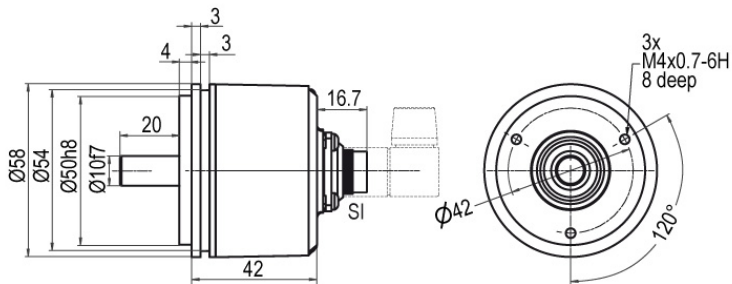





<b>K3</b>	radial, shield not connected	•
<b>L3</b>	radial, shield connected to encoder housing	•

Assignments					
	K3, L3	K3, L3	K3, L3	K3, L3	K3, L3
<b>Circuit</b>	G05, G24	F05, H05, F24, H24, H30	I05, I24, 524	P05, R05, P24, R24, 245, 645, R30	SIN
<b>GND</b>	WH	WH	WH	WH	WH
<b>(+) Vcc</b>	BN	BN	BN	BN	BN
<b>A</b>	GN	GN	GN	GN	GN
<b>B</b>	YE	YE	YE	YE	GY
<b>N</b>	GY	GY	GY	GY	-
<b>Light reserve warning</b>	PK	-	PK	-	-
<b>A inv.</b>	-	-	RD	RD	YE
<b>B inv.</b>	-	-	BK, (BU at ACA)	BK, (BU at ACA)	PK
<b>N inv.</b>	-	-	VT	VT	-
<b>Shield</b>	flex	flex	flex	flex	flex

**WDGI 58C: Connector (M16x0.75) SI, axial, 5-, 6-, 8-, 12-pin**

**Description**
**ABN inv. poss.**





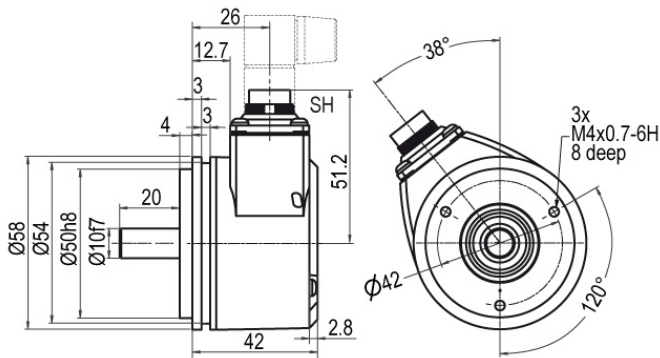





<b>SI5</b>	axial, 5-pin, Connector connected to encoder housing	-
<b>SI6</b>	axial, 6-pin, Connector connected to encoder housing	-
<b>SI8</b>	axial, 8-pin, Connector connected to encoder housing	•
<b>SI12</b>	axial, 12-pin, Connector connected to encoder housing	•

**Assignments**

	<b>SI5</b>	<b>SI6</b>	<b>SI6</b>	<b>SI8</b>	<b>SI8</b>	<b>SI8</b>	<b>SI12</b>	<b>SI12</b>	<b>SI12</b>	<b>SI12</b>	<b>SI12</b>
	<b>5-pin</b>	<b>6-pin</b>	<b>6-pin</b>	<b>8-pin</b>	<b>8-pin</b>	<b>8-pin</b>	<b>12-pin</b>	<b>12-pin</b>	<b>12-pin</b>	<b>12-pin</b>	<b>12-pin</b>
<b>Circuit</b>	 F05, H05, F24, H24, H30	 G05, G24	 F05, H05, F24, H24, H30	 F05, H05, F24, H24, H30	 P05, R05, P24, R24, R30, 245, 645	 SIN	 G05, G24	 F05, H05, F24, H24, H30	 I05, I24, 524	 P05, R05, P24, R24, 245, 645, R30	 SIN
<b>GND</b>	1	6	6	1	1	1	K, L	K, L	K, L	K, L	K, L
<b>(+) Vcc</b>	2	1	1	2	2	2	M, B	M, B	M, B	M, B	M, B
<b>A</b>	3	2	2	3	3	3	E	E	E	E	E
<b>B</b>	4	4	4	4	4	4	H	H	H	H	H
<b>N</b>	5	3	3	5	5	-	C	C	C	C	-
<b>Light reserve warning</b>	-	5	-	-	-	-	G	-	G	-	-
<b>A inv.</b>	-	-	-	-	6	6	-	-	F	F	F
<b>B inv.</b>	-	-	-	-	7	7	-	-	A	A	A
<b>N inv.</b>	-	-	-	-	8	-	-	-	D	D	-
<b>n. c.</b>	-	-	5	6, 7, 8	-	5, 8	A, D, F, J	A, D, F, G, J	J	G, J	D, G, J
<b>Shield</b>	-	-	-	-	-	-	-	-	-	-	-



**WDGI 58C: Connector (M16x0.75) SH, radial, 5-, 6-, 8-, 12-pin**

Description	ABN inv. poss.
<b>SH5</b> radial, 5-pin, Connector connected to encoder housing	-
<b>SH6</b> radial, 6-pin, Connector connected to encoder housing	-
<b>SH8</b> radial, 8-pin, Connector connected to encoder housing	•
<b>SH12</b> radial, 12-pin, Connector connected to encoder housing	•

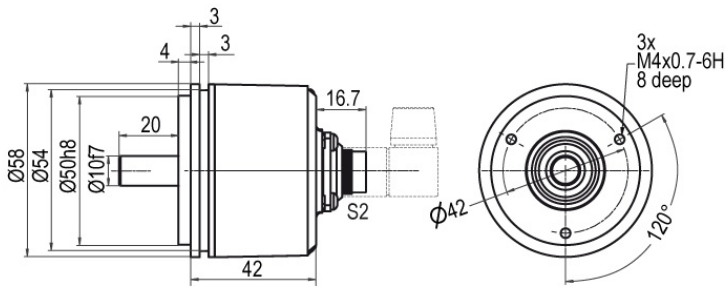
Assignments	SH5	SH6	SH6	SH8	SH8	SH8	SH12	SH12	SH12	SH12	SH12
	5-pin	6-pin	6-pin	8-pin	8-pin	8-pin	12-pin	12-pin	12-pin	12-pin	12-pin
											
<b>Circuit</b>	F05, H05, F24, H24, H30	G05, G24	F05, H05, F24, H24, H30	F05, H05, F24, H24, H30	P05, R05, P24, R24, R30, 245, 645	SIN	G05, G24	F05, H05, F24, H24, H30	I05, I24, 524	P05, R05, P24, R24, 245, 645, R30	SIN
<b>GND</b>	1	6	6	1	1	1	K, L	K, L	K, L	K, L	K, L
<b>(+) Vcc</b>	2	1	1	2	2	2	M, B	M, B	M, B	M, B	M, B
<b>A</b>	3	2	2	3	3	3	E	E	E	E	E
<b>B</b>	4	4	4	4	4	4	H	H	H	H	H
<b>N</b>	5	3	3	5	5	-	C	C	C	C	-
<b>Light reserve warning</b>	-	5	-	-	-	-	G	-	G	-	-
<b>A inv.</b>	-	-	-	-	6	6	-	-	F	F	F
<b>B inv.</b>	-	-	-	-	7	7	-	-	A	A	A
<b>N inv.</b>	-	-	-	-	8	-	-	-	D	D	-
<b>n. c.</b>	-	-	5	6, 7, 8	-	5, 8	A, D, F, J	A, D, F, G, J	J	G, J	D, G, J
<b>Shield</b>	-	-	-	-	-	-	-	-	-	-	-



**WDGI 58C: Connector (M16x0.75) S2, axial, 7-pin**

**Description**
**ABN inv. poss.**
**S2** axial, 7-pin, Connector connected to encoder housing

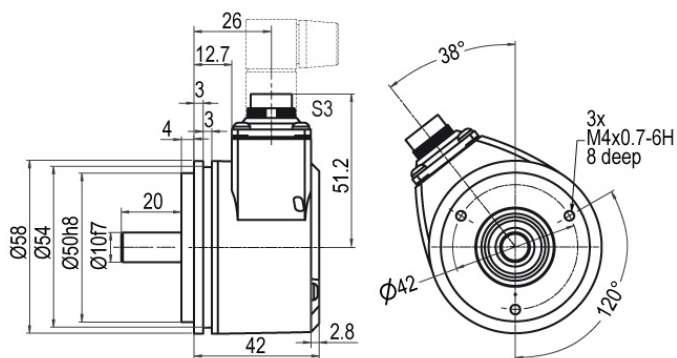
-

Assignments		
	S2 7-pin	S2 7-pin
		
<b>Circuit</b>	G05, G24	F05, H05, F24, H24, H30
<b>GND</b>	1	1
<b>(+) Vcc</b>	2	2
<b>A</b>	3	3
<b>B</b>	4	4
<b>N</b>	5	5
<b>Light reserve warning</b>	6	-
<b>A inv.</b>	-	-
<b>B inv.</b>	-	-
<b>N inv.</b>	-	-
<b>n. c.</b>	7	6, 7
<b>Shield</b>	-	-

**WDGI 58C: Connector (M16x0.75) S3, radial, 7-pin**

**Description**
**ABN inv. poss.**
**S3** radial, 7-pin, Connector connected to encoder housing



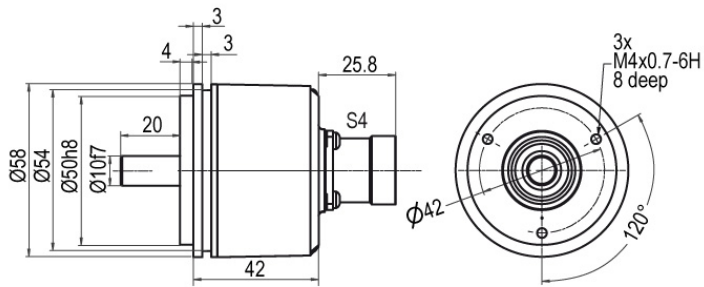

-

Assignments		
	S3	S3
	7-pin	7-pin
		
<b>Circuit</b>	G05, G24	F05, H05, F24, H24, H30
<b>GND</b>	1	1
<b>(+) Vcc</b>	2	2
<b>A</b>	3	3
<b>B</b>	4	4
<b>N</b>	5	5
<b>Light reserve warning</b>	6	-
<b>A inv.</b>	-	-
<b>B inv.</b>	-	-
<b>N inv.</b>	-	-
<b>n. c.</b>	7	6, 7
<b>Shield</b>	-	-





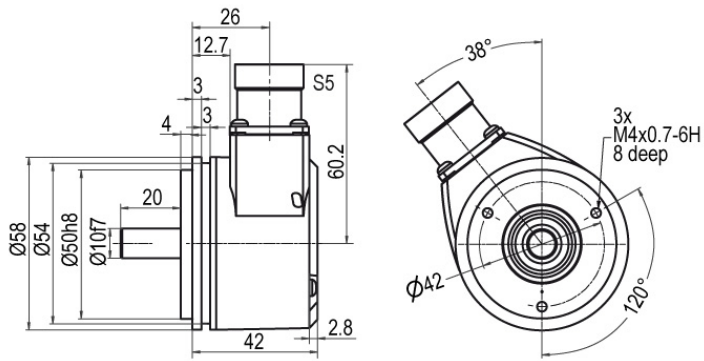

**WDGI 58C: Connector (M23) S4, axial, 12-pin**

**Description**
**ABN inv. poss.**
**S4** axial, 12-pin, Connector connected to encoder housing

•

Assignments					
	S4	S4	S4	S4	S4
	12-pin	12-pin	12-pin	12-pin	12-pin
					
<b>Circuit</b>	G05, G24	F05, H05, F24, H24, H30	I05, I24, 524	P05, R05, P24, R24, 245, 645, R30	SIN
<b>GND</b>	10	10	10	10	10
<b>(+) Vcc</b>	12	12	12	12	12
<b>A</b>	5	5	5	5	5
<b>B</b>	8	8	8	8	8
<b>N</b>	3	3	3	3	-
<b>Light reserve warning</b>	11	-	11	-	-
<b>A inv.</b>	-	-	6	6	6
<b>B inv.</b>	-	-	1	1	1
<b>N inv.</b>	-	-	4	4	-
<b>n. c.</b>	1, 2, 4, 6, 7, 9	1, 2, 4, 6, 7, 9, 11	2, 7, 9	2, 7, 9, 11	2, 3, 4, 7, 9, 11
<b>Shield</b>	-	-	-	-	-

**WDGI 58C: Connector (M23) S5, radial, 12-pin**

**Description**
**ABN inv. poss.**
**S5** radial, 12-pin, Connector connected to encoder housing

•

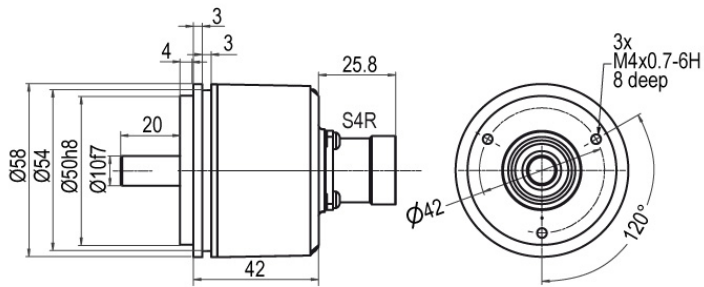
Assignments					
	S5	S5	S5	S5	S5
	12-pin	12-pin	12-pin	12-pin	12-pin
					
<b>Circuit</b>	G05, G24	F05, H05, F24, H24, H30	I05, I24, 524	P05, R05, P24, R24, 245, 645, R30	SIN
<b>GND</b>	10	10	10	10	10
<b>(+) Vcc</b>	12	12	12	12	12
<b>A</b>	5	5	5	5	5
<b>B</b>	8	8	8	8	8
<b>N</b>	3	3	3	3	-
<b>Light reserve warning</b>	11	-	11	-	-
<b>A inv.</b>	-	-	6	6	6
<b>B inv.</b>	-	-	1	1	1
<b>N inv.</b>	-	-	4	4	-
<b>n. c.</b>	1, 2, 4, 6, 7, 9	1, 2, 4, 6, 7, 9, 11	2, 7, 9	2, 7, 9, 11	2, 3, 4, 7, 9, 11
<b>Shield</b>	-	-	-	-	-

**WDGI 58C: Connector (M23) S4R, axial, 12-pin (clockwise)**

**Description**

ABN inv. poss.

**S4R** axial, 12-pin, Connector connected to encoder housing

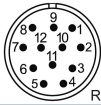
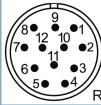
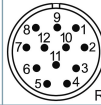
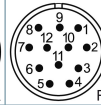
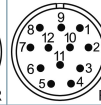
•

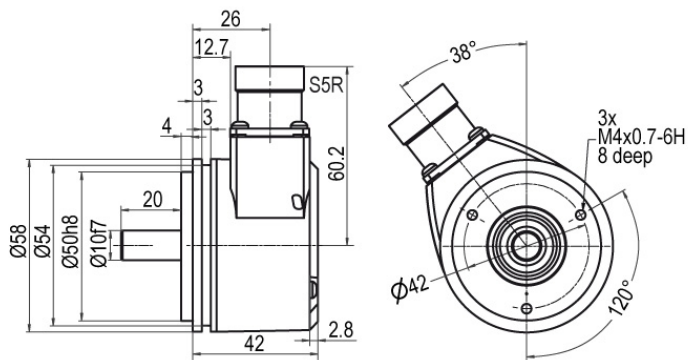
Assignments					
	S4R	S4R	S4R	S4R	S4R
	12-pin	12-pin	12-pin	12-pin	12-pin
					
<b>Circuit</b>	G05, G24	F05, H05, F24, H24, H30	I05, I24, 524	P05, R05, P24, R24, 245, 645, R30	SIN
<b>GND</b>	10	10	10	10	10
<b>(+) Vcc</b>	12	12	12	12	12
<b>A</b>	5	5	5	5	5
<b>B</b>	8	8	8	8	8
<b>N</b>	3	3	3	3	-
<b>Light reserve warning</b>	11	-	11	-	-
<b>A inv.</b>	-	-	6	6	6
<b>B inv.</b>	-	-	1	1	1
<b>N inv.</b>	-	-	4	4	-
<b>n. c.</b>	1, 2, 4, 6, 7, 9	1, 2, 4, 6, 7, 9, 11	2, 7, 9	2, 7, 9, 11	2, 3, 4, 7, 9, 11
<b>Shield</b>	-	-	-	-	-





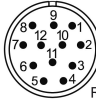
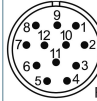
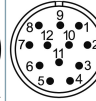
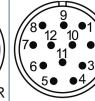
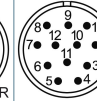

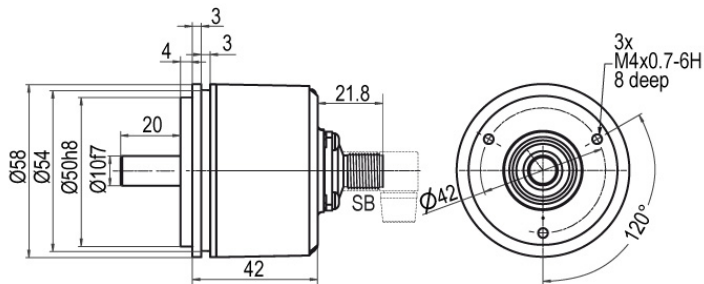

**WDGI 58C: Connector (M23) S5R, radial, 12-pin (clockwise)**

**Description**
**ABN inv. poss.**
**S5R** radial, 12-pin, Connector connected to encoder housing

•

Assignments					
	S5R	S5R	S5R	S5R	S5R
	12-pin	12-pin	12-pin	12-pin	12-pin
					
<b>Circuit</b>	G05, G24	F05, H05, F24, H24, H30	I05, I24, 524	P05, R05, P24, R24, 245, 645, R30	SIN
<b>GND</b>	10	10	10	10	10
<b>(+) Vcc</b>	12	12	12	12	12
<b>A</b>	5	5	5	5	5
<b>B</b>	8	8	8	8	8
<b>N</b>	3	3	3	3	-
<b>Light reserve warning</b>	11	-	11	-	-
<b>A inv.</b>	-	-	6	6	6
<b>B inv.</b>	-	-	1	1	1
<b>N inv.</b>	-	-	4	4	-
<b>n. c.</b>	1, 2, 4, 6, 7, 9	1, 2, 4, 6, 7, 9, 11	2, 7, 9	2, 7, 9, 11	2, 3, 4, 7, 9, 11
<b>Shield</b>	-	-	-	-	-







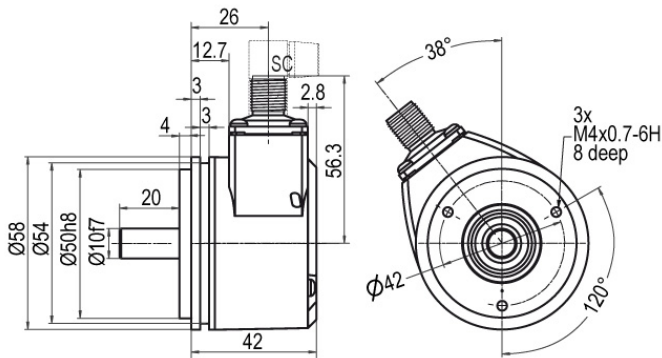

**WDGI 58C: Sensor-connector (M12x1) SB, axial, 4-, 5-, 8-, 12-pin**

Description	ABN inv. poss.
<b>SB4</b> axial, 4-pin, Connector connected to encoder housing	-
<b>SB5</b> axial, 5-pin, Connector connected to encoder housing	-
<b>SB8</b> axial, 8-pin, Connector connected to encoder housing	•
<b>SB12</b> axial, 12-pin, Connector connected to encoder housing	•

Assignments	SB4	SB5	SB8	SB8	SB8	SB12	SB12	SB12	SB12
	4-pin	5-pin	8-pin	8-pin	8-pin	12-pin	12-pin	12-pin	12-pin
									
<b>Circuit</b>	F05, H05, F24, H24, H30	F05, H05, F24, H24, H30	F05, H05, F24, H24, H30	P05, R05, P24, R24, R30, 245, 645	SIN	G05, G24	F05, H05, F24, H24, H30	I05, I24, 524	P05, R05, P24, R24, 245, 645, R30
<b>GND</b>	3	3	1	1	1	3	3	3	3
<b>(+) Vcc</b>	1	1	2	2	2	1	1	1	1
<b>A</b>	2	4	3	3	3	4	4	4	4
<b>B</b>	4	2	4	4	5	6	6	6	6
<b>N</b>	-	5	5	5	-	8	8	8	8
<b>Light reserve warning</b>	-	-	-	-	-	5	-	5	-
<b>A inv.</b>	-	-	-	6	4	-	-	9	9
<b>B inv.</b>	-	-	-	7	6	-	-	7	7
<b>N inv.</b>	-	-	-	8	-	-	-	10	10
<b>n. c.</b>	-	-	6, 7, 8	-	7, 8	2, 7, 9, 10, 11, 12	2, 5, 7, 9, 10, 11, 12	2, 11, 12	2, 5, 11, 12
<b>Shield</b>	-	-	-	-	-	-	-	-	-

**WDGI 58C: Sensor-connector (M12x1) SC, radial, 4-, 5-, 8-, 12-pin**

Description	ABN inv. poss.
<b>SC4</b> radial, 4-pin, Connector connected to encoder housing	-
<b>SC5</b> radial, 5-pin, Connector connected to encoder housing	-
<b>SC8</b> radial, 8-pin, Connector connected to encoder housing	•
<b>SC12</b> radial, 12-pin, Connector connected to encoder housing	•

Assignments	SC4	SC5	SC8	SC8	SC8	SC12	SC12	SC12	SC12
	4-pin	5-pin	8-pin	8-pin	8-pin	12-pin	12-pin	12-pin	12-pin
									
<b>Circuit</b>	F05, H05, F24, H24, H30	F05, H05, F24, H24, H30	F05, H05, F24, H24, H30	P05, R05, P24, R24, R30, 245, 645	SIN	G05, G24	F05, H05, F24, H24, H30	I05, I24, 524	P05, R05, P24, R24, 245, 645, R30
<b>GND</b>	3	3	1	1	1	3	3	3	3
<b>(+) Vcc</b>	1	1	2	2	2	1	1	1	1
<b>A</b>	2	4	3	3	3	4	4	4	4
<b>B</b>	4	2	4	4	5	6	6	6	6
<b>N</b>	-	5	5	5	-	8	8	8	8
<b>Light reserve warning</b>	-	-	-	-	-	5	-	5	-
<b>A inv.</b>	-	-	-	6	4	-	-	9	9
<b>B inv.</b>	-	-	-	7	6	-	-	7	7
<b>N inv.</b>	-	-	-	8	-	-	-	10	10
<b>n. c.</b>	-	-	6, 7, 8	-	7, 8	2, 7, 9, 10, 11, 12	2, 5, 7, 9, 10, 11, 12	2, 11, 12	2, 5, 11, 12
<b>Shield</b>	-	-	-	-	-	-	-	-	-

## Options

### Low temperature

The encoder WDGI 58C with the output circuit types F24, G24, H24, I24, P24, R24, F05, G05, H05, I05, P05, R05, 245, 524, 645 is also available with the extended temperature range -40 °C up to +85 °C [-40 °F up to +185 °F] (measured at the flange).

### Order key

**ACA**

### Pressure equalising membrane

The WDGI 58C shaft encoder is also optionally available with a pressure equalising membrane. This prevents water from penetrating into the encoder housing in the case of high air humidity.

The IP67 protection level, temperature range and salt spray resistance are maintained. Resistant to chemicals and solvents in accordance with DIN EN ISO 2812-1.

### Order key

**ACR**

### Cable length

The encoder WDGI 58C can be supplied with more than 2 m cable. The maximum cable length depends on the supply voltage and the frequency; see [www.wachendorff-automation.com/atd](http://www.wachendorff-automation.com/atd)

Please extend the standard order code with a three figure number, specifying the cable length in decimetres.

Example: 5 m cable = 050

### Order key

**XXX = Decimeter**

Example Order No.	Type					Your encoder
WDGI 58C	WDGI 58C					WDGI 58C
<b>Shaft</b>						
10	10					
<b>Pulses per revolution PPR:</b>						
5000	2, 5, 10, 15, 20, 24, 25, 30, 36, 40, 48, 50, 60, 64, 72, 87, 90, 100, 120, 125, 127, 128, 150, 160, 180, 200, 216, 236, 240, 250, 254, 256, 300, 314, 320, 360, 400, 500, 512, 571, 600, 625, 720, 750, 768, 800, 810, 900, 1000, 1024, 1200, 1250, 1270, 1440, 1500, 1800, 2000, 2048, 2400, 2500, 3000, 3600, 4000, 4096, 4685, 5000, 10000, 12500, 20000, 25000 1 Vpp Sin/Cos only 1024, 2048 Other PPRs on request					
<b>Channels:</b>						
ABN	AB, ABN (SIN: AB)					
<b>Output circuit</b>						
G24	Resolution PPR	Power supply VDC	Output circuit	Light reserve warning	Order key	
	up to 2500	5 - 30	HTL	-	H30	
		5 - 30	HTL inverted	-	R30	
	up to 5000	4.75 - 5.5	TTL	•	G05	
		4.75 - 5.5	TTL	-	H05	
		4.75 - 5.5	TTL, RS422 comp., inverted	•	I05	
		4.75 - 5.5	TTL, RS422 comp., inverted	-	R05	
		10 - 30	HTL	•	G24	
		10 - 30	HTL	-	H24	
		10 - 30	HTL inverted	•	I24	
		10 - 30	HTL inverted	-	R24	
		10 - 30	TTL, RS422 comp., inverted	•	524	
		10 - 30	TTL, RS422 comp., inverted	-	245	
	(higher frequency) 1200 up to 25000	4.75 - 5.5	TTL	-	F05	
		4.75 - 5.5	TTL, RS422 comp., inverted	-	P05	
		10 - 30	HTL	-	F24	
		10 - 30	HTL inverted	-	P24	
		10 - 30	TTL, RS422 comp., inverted	-	645	
1024, 2048	4.75 - 5.5	1 Vpp sin/cos	-	SIN		



Electrical connections				
Description	ABN inv. poss.	Order key		
<b>Cable: length (2 m standard, WDG 58T: 1 m)</b>				
axial, shield not connected	•	K2	K2	
axial, shield connected to encoder housing	•	L2		
radial, shield not connected	•	K3		
radial, shield connected to encoder housing	•	L3		
<b>Connector: (shield connected to encoder housing)</b>				
connector, M16x0.75, 5-pin, axial	-	SI5		
connector, M16x0.75, 5-pin, radial	-	SH5		
connector, M16x0.75, 6-pin, axial	-	SI6		
connector, M16x0.75, 6-pin, radial	-	SH6		
connector, M16x0.75, 8-pin, axial	•	SI8		
connector, M16x0.75, 8-pin, radial	•	SH8		
connector, M16x0.75, 12-pin, axial	•	SI12		
connector, M16x0.75, 12-pin, radial	•	SH12		
connector, M16x0.75, 7-pin, axial	-	S2		
connector, M16x0.75, 7-pin, radial	-	S3		
connector, M23, 12-pin, axial	•	S4		
connector, clockwise pin count, M23, 12-pin, axial	•	S4R		
connector, M23, 12-pin, radial	•	S5		
connector, clockwise pin count, M23, 12-pin, radial	•	S5R		
sensor-connector, M12x1, 4-pin, axial	-	SB4		
sensor-connector, M12x1, 4-pin, radial	-	SC4		
sensor-connector, M12x1, 5-pin, axial	-	SB5		
sensor-connector, M12x1, 5-pin, radial	-	SC5		
sensor-connector, M12x1, 8-pin, axial	•	SB8		
sensor-connector, M12x1, 8-pin, radial	•	SC8		
sensor-connector, M12x1, 12-pin, axial	•	SB12		
sensor-connector, M12x1, 12-pin, radial	•	SC12		
<b>Options</b>				
Description	Order key			
Low temperature	ACA			
Pressure equalising membrane	ACR			
Without option	Empty			
Cable length	XXX = Decimeter			

<b>Example Order No.=</b>	WDGI 58C	10	5000	ABN	G24	K2			WDGI 58C						<b>Your encoder</b>
---------------------------	----------	----	------	-----	-----	----	--	--	----------	--	--	--	--	--	---------------------



For further information please contact our local distributor.  
Here you find a list of our distributors worldwide.  
[http://www.wachendorff-automation.com/distributors\\_worldwide.html](http://www.wachendorff-automation.com/distributors_worldwide.html)



Wachendorff Automation GmbH & Co. KG  
Industriestrasse 7 • D-65366 Geisenheim

Phone: +49 67 22 / 99 65 25  
Fax: +49 67 22 / 99 65 70  
E-Mail: [wdg@wachendorff.de](mailto:wdg@wachendorff.de)  
[www.wachendorff-automation.de](http://www.wachendorff-automation.de)

